

Duratuf[®]

LIFESTYLE RANGE



**Under
30sqm.**

No permit
required

30 YEAR STEEL CLADDING
30
WARRANTY

**NEW
ZEALAND
MADE**

THE ULTIMATE IN STYLISH, SECURE STORAGE

WWW.DURATUF.CO.NZ/LIFESTYLE



LIFESTYLE RANGE

Designed to meet the needs of a range of Kiwi lifestyles, the Duratuf Lifestyle Range is the ultimate in stylish, secure storage. With models that suit high density suburban living to sprawling country estates you're sure to find one that fits your requirements.

Made right here in New Zealand from quality materials and components by our team with over 25 years of kitset building experience, a Duratuf Lifestyle shed is a worthy investment that'll pay off for decades to come.



Features at a Glance



Engineer Approved

The Duratuf Lifestyle sheds over 10m² have been reviewed and certified by a chartered professional engineer. This means you do not need building consent to build one, provided you meet any other local council regulations.



No Permit Required Under 30sqm

Building a garden shed that is under 30 square metres in size does not require a permit, offering you a straightforward solution for adding extra storage space to your property. This means that homeowners and DIY enthusiasts can construct a shed of this size without having to obtaining a permit.



Timeless Design

Horizontal corrugate cladding and wide gauge box flashings create a modern yet classic design aesthetic that looks striking on any landscape.



Generous Headroom

An impressive stud height means even the tallest loose forward won't go bumping their head. More importantly, it gives you much needed extra space on a smaller footprint, and allows you to store tall items and other gear in a space-saving vertical position.



Superior Weatherproofing

Water is the last thing you want inside your shed. So while other brand sheds have steel channels that allow it to pool and corrode, Duratuf Lifestyle sheds have effective flashings to stop it getting in, and spouting to make sure it moves on quickly, either down the drain or diverted to a water tank or rain barrel.

(Downpipe kit required for Ponsonby and Fendalton models)



Secure Roller Door

High and wide so you can get everything inside. A quality New Zealand made roller door provides uninhibited access for larger items, while giving you peace of mind knowing your valuable gear is kept safe from theft.

Available in many popular colour options (see page 14), combine it with your preferred shed colour to create a colour scheme tailored to your property.



Structural Timber Framing

Like all Duratuf sheds the Lifestyle Range features a robust timber frame. This not only gives them a solid structural backbone, in addition it does away with the need for steel channels that invite leaks and corrosion. Plus it gives you plenty of options when it comes to hanging up tools, or adding shelves and workbenches.

All timber is machine gauged, appropriately treated, and sourced from renewable New Zealand pine forests. Roof beams are hi-span laminated structural beams for the ultimate in strength and durability.



Solid Steel Cladding

Not only does it look great, our hi-tensile 0.4mm Armorsteeel steel cladding with multi-layered paint coating is tough enough to resist even New Zealand's most extreme weather conditions. We're so confident that we back it up with a 30 year guarantee.

Available in many popular colour options (see page 14), combine it with your preferred door colour to create a colour scheme tailored to your property.

Models

View the full range at www.duratuf.co.nz/lifestyle



Ponsonby

Product Code: LMP

The ideal size to store your sports gear, lawnmower and tools while adding a touch of class to your unused space.

Base Dimensions	
Width	Depth
2.400m	1.000m

Door Width	Door Clearance Height
1.800m	1.890m

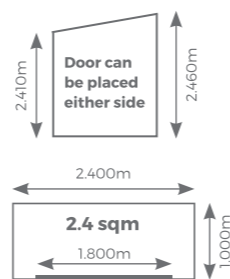

Windsor

Product Code: LNL2415

Ideal storage against the house or hard against the fence.

Base Dimensions	
Width	Depth
2.400m	1.500m

Door Width	Door Clearance Height
1.800m	1.910m

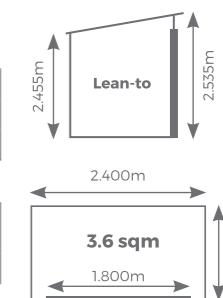

Fendalton

Product Code: LMF

With extra width and a wider roller door the Fendalton provides secure storage for larger items.

Base Dimensions	
Width	Depth
3.150m	1.000m

Door Width	Door Clearance Height
2.400m	1.890m

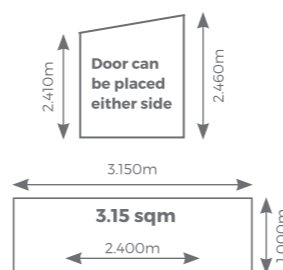

Cardrona

Product Code: LNL3115

Superb size to keep your mower, wheelbarrow and other gardening gear.

Base Dimensions	
Width	Depth
3.150m	1.500m

Door Width	Door Clearance Height
2.400m	1.910m

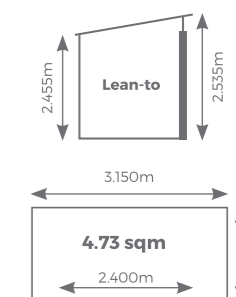

Optional Downpipe Kit

Upgrade your Duratuf Ponsonby or Fendalton with the PVC downpipe kit. This kit comes complete with a cover flashing, making it a comprehensive solution for managing rainwater.

Models

View the full range at www.duratuf.co.nz/lifestyle



Under 30sqm.
No permit required



Matakana

Product Code: LEMK

Provides a secure, out of the way place to store bikes, BBQs, and any other belongings.

Base Dimensions	
Width	Depth
2.400m	2.000m

Door Width	Door Clearance Height
1.800m	1.910m

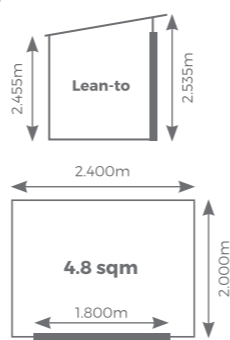

Tamahere

Product Code: LET

The ultimate bike shed. Whether it's pedalled or motorised.

Base Dimensions	
Width	Depth
4.000m	2.000m

Door Width	Door Clearance Height
2.400m	1.910m

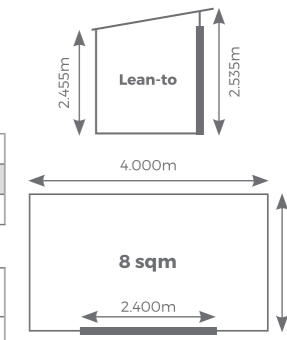

Milford

Product Code: LEMF

Ideal as a tackroom, parking spot for your quad bike, or a silo to store feed for livestock.

Base Dimensions	
Width	Depth
3.150m	2.000m

Door Width	Door Clearance Height
2.400m	1.910m

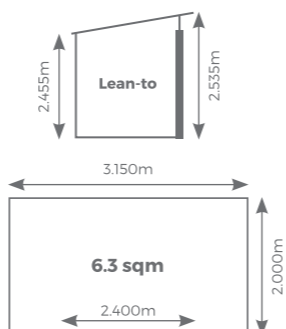

Waimate

Product Code: LEW

A big 5 metres wide, great space for an easy access workshop.

Base Dimensions	
Width	Depth
5.000m	2.000m

Door Width	Door Clearance Height
2.400m	1.910m

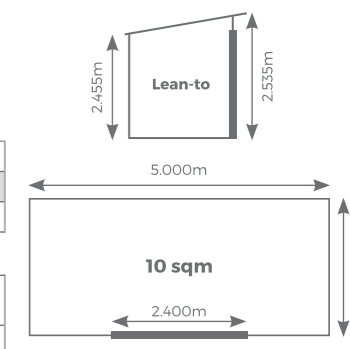

Models

View the full range at www.duratuf.co.nz/lifestyle



Kaipara

Product Code: LRK

Makes for a good sized workshop with extra room on each side to set up workbenches and shelving.

Base Dimensions	
Width	Depth
3.900m	2.550m

Door Width	Door Clearance Height
2.400m	1.990m

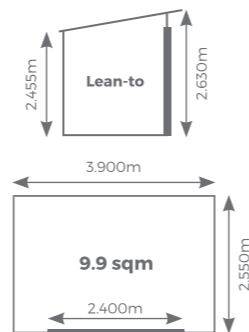

Whitford

Product Code LLW

A wide shed giving you space for a workbench and shelving.

Base Dimensions	
Width	Depth
4.800m	3.600m

Door Width Options	
2.400m	3.000m

Door Clearance Height
1.990m

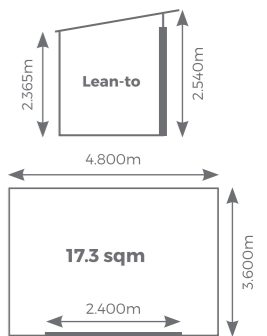

Marlborough

Product Code: LRM

Added depth provides plenty of space for your ride on mower with ample room for additional storage.

Base Dimensions	
Width	Depth
3.150m	3.150m

Door Width	Door Clearance Height
2.400m	1.990m

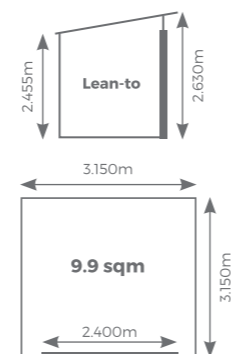

Otago

Product Code LNL6036

A big 6m wide, for the perfect sized workshop with loads of extra room.

Base Dimensions	
Width	Depth
6.000m	3.600m

Door Width Options	
2.400m	3.000m

Door Clearance Height
1.990m

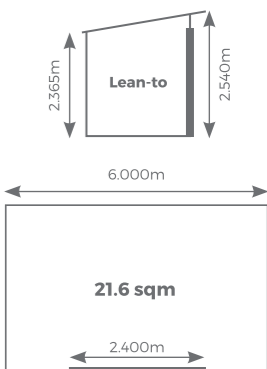

Models

View the full range at www.duratuf.co.nz/lifestyle



Kinloch

Product Code LLK

A deep shed perfect for storing long items in a narrow space.

Base Dimensions	
Width	Depth
2.400m	4.200m

Door Width	Door Clearance Height
1.800m	1.990m

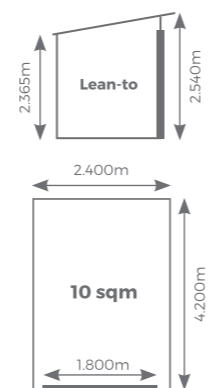

Havelock

Product Code LLH

A slightly deeper version of the Whitford for those who need extra room.

Base Dimensions	
Width	Depth
4.800m	4.200m

Door Width Options	
2.400m	3.000m

Door Clearance Height
1.990m

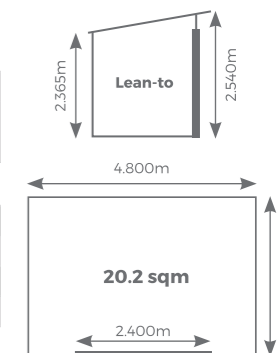

Wairarapa

Product Code LNL3660

At a huge 6m deep it makes for a great for storing and working on the hobbies.

Base Dimensions	
Width	Depth
3.600m	6.000m

Door Width	Door Clearance Height
2.400m	2.070m

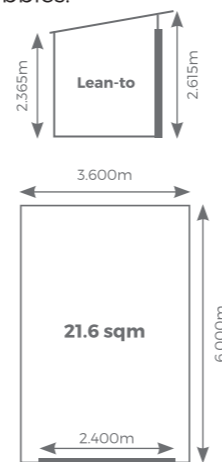

Glenburn

Product Code LNL4248

With a spacious interior, the Glenburn has ample room for large garden machinery such as ride-on mowers and concrete mixers etc.

Base Dimensions	
Width	Depth
4.200m	4.800m

Door Width Options	
2.400m	3.000m

Door Clearance Height
2.070m

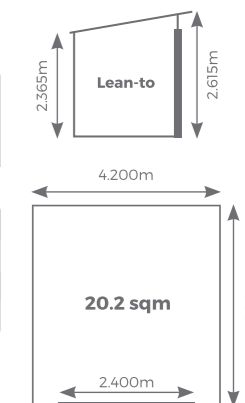

Models

View the full range at www.duratuf.co.nz/lifestyle



Ardmore

Product Code LLA

The square shed that's an all round performer.

Base Dimensions	
Width	Depth
4.800m	4.800m

Door Width Options	
2.400m	3.000m

Door Clearance Height
2.070m

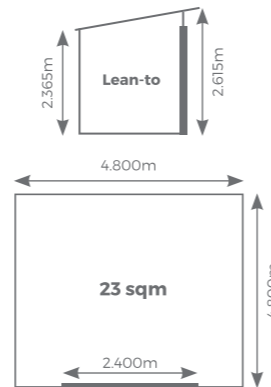

Kapiti

Product Code LNL6042

Perfect size for the ultimate boat shed.

Base Dimensions	
Width	Depth
6.000m	4.200m

Door Width Options	
2.400m	3.000m

Door Clearance Height
1.990m

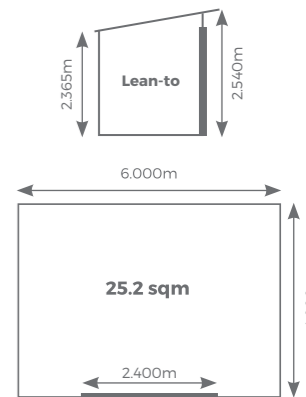

Paihia

Product Code LLP

At a huge 6m deep it makes for a great boatshed.

Base Dimensions	
Width	Depth
4.800m	6.000m

Door Width Options	
2.400m	3.000m

Door Clearance Height
2.070m

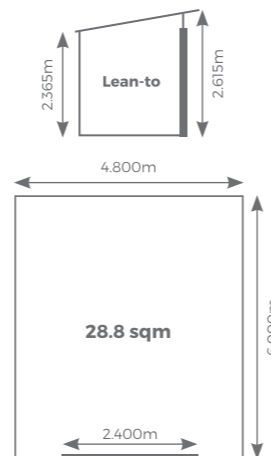

Oxford

Product Code LLO

A big 6m wide, and about as close as you'll get to the 30m2 limit.

Base Dimensions	
Width	Depth
6.000m	4.800m

Door Width Options	
2.400m	3.000m

Door Clearance Height
2.070m

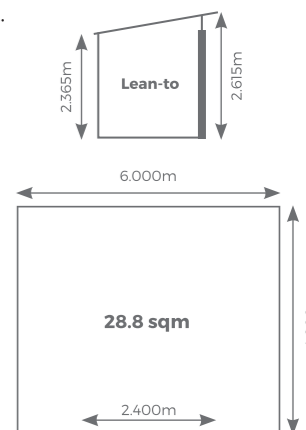

Optional upgrades



Add PA Doors or Windows

A Pedestrian Access door (810mm W x 1920mm H) and fixed or opening aluminium joinery window (970mm W x 520mm H) can be added in multiple locations on your Lifestyle shed.



Automatic Door Kit

Access your Lifestyle shed at the click of a button with the remote controlled automatic door kit. A popular addition for those wanting complete convenience.



Clear Roof Panel

Enjoy natural daylight in your shed without the harmful effects of UV rays, thanks to the clear roof panels. These panels are designed to integrate seamlessly with the steel roof sheet, and are available as an optional upgrade for any Lifestyle shed.



Coastal upgrade



Because we are so confident in the quality of our cladding, we back it up with a 30-year warranty in non-coastal regions (*conditions apply*). For those sheds in coastal areas, we also offer a high-durability grade of cladding option for your peace of mind. With an extra thick layer of zinc-aluminium protection, our Coastal grade cladding provides enhanced resistance to the harsh conditions in New Zealand's coastal environment.

For full details of our Coastal Upgrade Option, refer to www.duratuf.co.nz/duratuf-warranty.

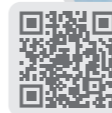

Very High Wind Upgrade Kit

Built with safety, strength, and durability in mind, the Lifestyle shed range has a timber-reinforced heavy-duty construction, engineered to NZS 3604 High Wind Zone specification. The Lifestyle shed can withstand most of Mother Nature's wear and tear, but for those Very High Wind Zone areas, we offer a NZS 3604 Very High Wind Zone shed upgrade kit. **For more information regarding wind zones, visit the Branz website:** <https://www.branz.co.nz/branz-maps-zones/>

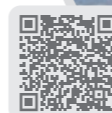

Snow Load Upgrade Kit

Live in New Zealand's high country where snowfalls are regular? We have you covered with a NZS 3605 standard 1 kPa engineered load rating on all our Lifestyle sheds. However, for those higher elevation areas with severe snow, the Snow Load Upgrade Kit is a perfect addition to your Lifestyle shed, with a 2kPa upgrade Snow Load kit option to suit NZS 3604 standards, reinforcing the sheds inner roof structure. **For a NZ snow load map visit:** https://www.level.org.nz/fileadmin/downloads/Site_Analysis/Snow_Zones_Map.pdf



Colour Options

You can choose any combination of shed and door colour.

With a wide range of popular cladding colours you're sure to find a colour scheme to match your property.



Flooring Options

While the Ponsonby and Fendalton models are able to sit on an existing substrate like a driveway, deck or patio, all other models are designed to sit on a purpose built raised floor. As the cladding overhangs the bottom framing by 30mm to eliminate water ingress. We can provide this with our Plywood or Timber Floor Kit, otherwise you can lay a concrete pad or fabricate something to suit.

Note: Models over 10m2 require a concrete slab that meets the NZ Building Code to be compliant

Plywood Floor Kit

Includes cut to size 17mm H3 plywood sheets, ground treated H4 joists, treadplate doorway flashing and all required hardware.

Timber Floor Kit

Includes cut to length thick gauge H3 timber floorboards, ground treated H4 joists, treadplate doorway flashing and all required hardware. (floorboards supplied in separate pack from main kitset)



Building A Raised Concrete Base

- Step 1** - Establish size of shed and excavate sufficient area. Remember to allow for roof overhang of 150mm on the back wall and 50mm on the side walls.
- Step 2** - Ensure that the base substrate is compacted firmly. The concrete slab should be 100mm thick in the middle and 200mm thick around the edges (Fig 2).
- Step 3** - Lay boxing to the required size. Check the base is square and the diagonal measurements are equal. The raised slab size should be 20mm smaller than the overall base size of the shed and at least 50mm above the ground line. (Fig. 1)
- Step 4** - Lay plastic sheeting under slab to prevent moisture coming through from underneath.
- Step 5** - Pour concrete and screed flush.

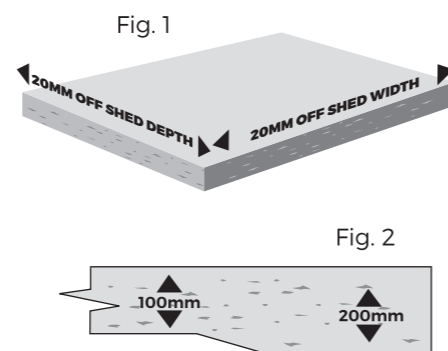

Accessories



Clear Roof Panel



5 Tier Shelf Unit



Automatic Door Kit



Downpipe Kit**

** Required for Ponsonby/Fendalton only. All other models have PVC downpipes as standard.



Shed Alarm



Heavy Duty Workbench



Assembly Options

Lifestyle sheds are a great project for a competent DIYer, otherwise we recommend hiring a builder or an assembly service. Visit Duratuf.co.nz to view our recommended assemblers.



Tools Required



Kitset Pack

Lifestyle sheds are delivered in a single crate as a ready to build kitset and come with comprehensive assembly instructions.

If ordered with a Timber Floor Kit this will be packaged separately.

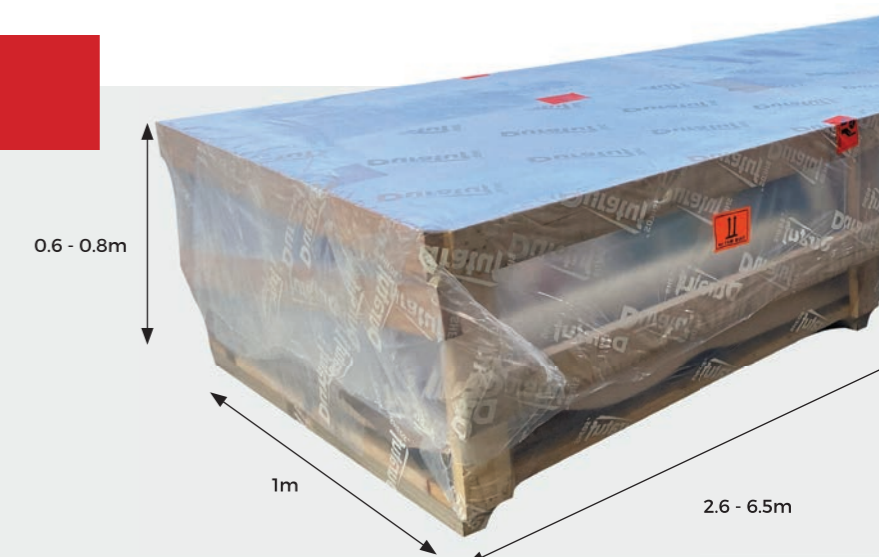

THE ULTIMATE IN STYLISH, SECURE STORAGE



Duratuf
LIFESTYLE®

Customer Helpline (weekdays)

Call 0800 GET A SHED | 0800 438 274

Riverlea Group Ltd | PO Box 11062 | Hamilton 3251 | New Zealand | +64 7 847 0204

