

# Duratuf<sup>TM</sup>

Quality - Made Affordable

## ASSEMBLY INSTRUCTIONS



**WS400 / BS400**

BASE SIZE 1980mm x 1355mm

# Duratuf

## FORTRESS

CHECK OUT OUR ASSEMBLY VIDEO

## Let Keith and Justin show you how to build your Fortress shed like a professional.

When used in conjunction with these assembly instructions, Keith's practical tips and tricks will make your assembly experience that much simpler, giving you visual guidance through sections that seem tricky on paper, and help you achieve a flawless end result.

To view the video visit [www.duratuf.co.nz/fortress-assembly](http://www.duratuf.co.nz/fortress-assembly)



**Note:** Assembly video features a TUF400. But can be used for reference for any other Fortress model.

# Duraturf

## FORTRESS

### ASSEMBLY INSTRUCTIONS

#### Tools Required:

- Drill
- Drill Bit 3.5mm
- Drill Bit 6mm (**Only required if installing an optional Clear Roof Panel**)
- Masonry Drill and 10mm Masonry Bit (**Only required if installing a Bolt Down Kit**)
- Riveter
- Hammer
- Nail Punch
- Tape Measure
- Ladder or Saw stool
- String Line
- Hex Bit 8mm
- Skill Saw or Jig Saw (for floor only)

#### IMPORTANT

**SUNSCREEN WARNING:** Prevent contact of the painted surface with sunscreens containing titanium dioxide (TiO<sub>2</sub>) or zinc oxide (ZnO). It has been proven to discolour and degrade the paint finish. The use of gloves is recommended.

Damage to prepainted steel caused by contact with sunscreen is not covered by your Duraturf warranty.

#### Before you start:



- Read all instructions carefully.
- Identify all parts and check the quantities against checklist.
- If you are pouring your own raised concrete floor, please refer to Raised Base Plate section now to familiarise yourself with the procedure prior to starting.

#### Safety:

- Before assembly, remove protective film where present from all flashings and coloured steel components.
- Do not attempt to build your shed in high winds.
- Beware of sharp edges. For safety wear protective gloves—preferably rubber coated)
- Protect your eyes and ears with the appropriate safety gear
- Use electric tools with care. Use a Safety Trip Switch.
- It is easier and quicker if this shed is erected by two people.



#### Select your site:



- Your shed must be level. You can achieve this by either levelling and compacting the ground or by using blocks or piles to create a level platform for the shed framing to sit on.
- If your shed is to be positioned on wet or damp ground, we recommend that your shed is raised up off the ground slightly to avoid moisture and mould in the shed. A Damp Proof Course (DPC) membrane can also be used. This is available from your local hardware store.

# WS/BS400 PARTS LIST

**COLOUR:** \_\_\_\_\_ **INV #:** \_\_\_\_\_

**ROOF SIZE: 2.010 x 1.890**

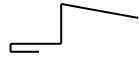
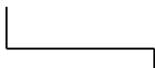
**BASE SIZE: 1.980 x 1.355**

QTY	LENGTH	DESCRIPTION	CHECKED OUT	CHECKED IN
4	1.890	Corner Wall Sheets	<input type="checkbox"/>	<input type="checkbox"/>
2	1.890	Wall Sheets	<input type="checkbox"/>	<input type="checkbox"/>
1	1.890	Roof Sheet	<input type="checkbox"/>	<input type="checkbox"/>
2	1.890	Folded Roof Sheets	<input type="checkbox"/>	<input type="checkbox"/>
<b>TIMBER</b>				
<b>BASE PLATES</b>				
2	1.980	Front & Back - Green 45 x 45 H4	<input type="checkbox"/>	<input type="checkbox"/>
2	1.355	Ends - Green 45 x 45 H4	<input type="checkbox"/>	<input type="checkbox"/>
<b>TOP PLATES</b>				
1	1.980	Back - Red 45 x 45 H1	<input type="checkbox"/>	<input type="checkbox"/>
1	1.980	Front - Red 90 x 45 H1	<input type="checkbox"/>	<input type="checkbox"/>
2	1.355	Ends - Red 45 x 45 H1	<input type="checkbox"/>	<input type="checkbox"/>
4	1.810	Studs - Yellow 45 x 45 H1	<input type="checkbox"/>	<input type="checkbox"/>
2	1.833	Studs - Blue 45 x 45 H1	<input type="checkbox"/>	<input type="checkbox"/>
4	1.265	End Wall Nogs 45 x 45 H1	<input type="checkbox"/>	<input type="checkbox"/>
2	0.106	Front Left Nog 45 x 45 H1	<input type="checkbox"/>	<input type="checkbox"/>
2	0.100	Front Right Nog 45 x 45 H1	<input type="checkbox"/>	<input type="checkbox"/>
2	1.890	Back Wall Nog 45 x 45 H1	<input type="checkbox"/>	<input type="checkbox"/>
<b>FLASHINGS</b>				
2	1.890	Door Jambs 	<input type="checkbox"/>	<input type="checkbox"/>
1	2.000	Top Plate Flashing 	<input type="checkbox"/>	<input type="checkbox"/>
1	2.010	Roof Flashing 	<input type="checkbox"/>	<input type="checkbox"/>
1		Hardware Pack	<input type="checkbox"/>	<input type="checkbox"/>
1		Assembly Instructions	<input type="checkbox"/>	<input type="checkbox"/>
1		Duratuf Riveter	<input type="checkbox"/>	<input type="checkbox"/>
1		Touch-up Paint & Brush	<input type="checkbox"/>	<input type="checkbox"/>
<b><u>BUS SHELTER SEAT ONLY</u></b>				
<b><u>Seat Boards</u></b>				
3	1.980	140x45 H1	<input type="checkbox"/>	<input type="checkbox"/>
<b><u>Centre Brace</u></b>				
2	0.310	Verticals 45x45 H1	<input type="checkbox"/>	<input type="checkbox"/>
2	0.405	Horizontals 45x45 H1	<input type="checkbox"/>	<input type="checkbox"/>
<b><u>Hardware</u></b>				
24	75mm	75x8g Surefast Screws	<input type="checkbox"/>	<input type="checkbox"/>

**PACKED BY:** \_\_\_\_\_

**DATE:**     /     /

# WS400 TIMBER FRAME

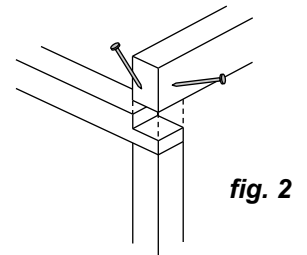
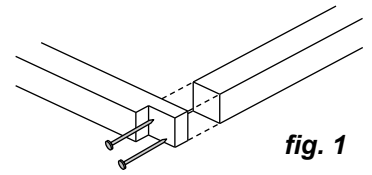
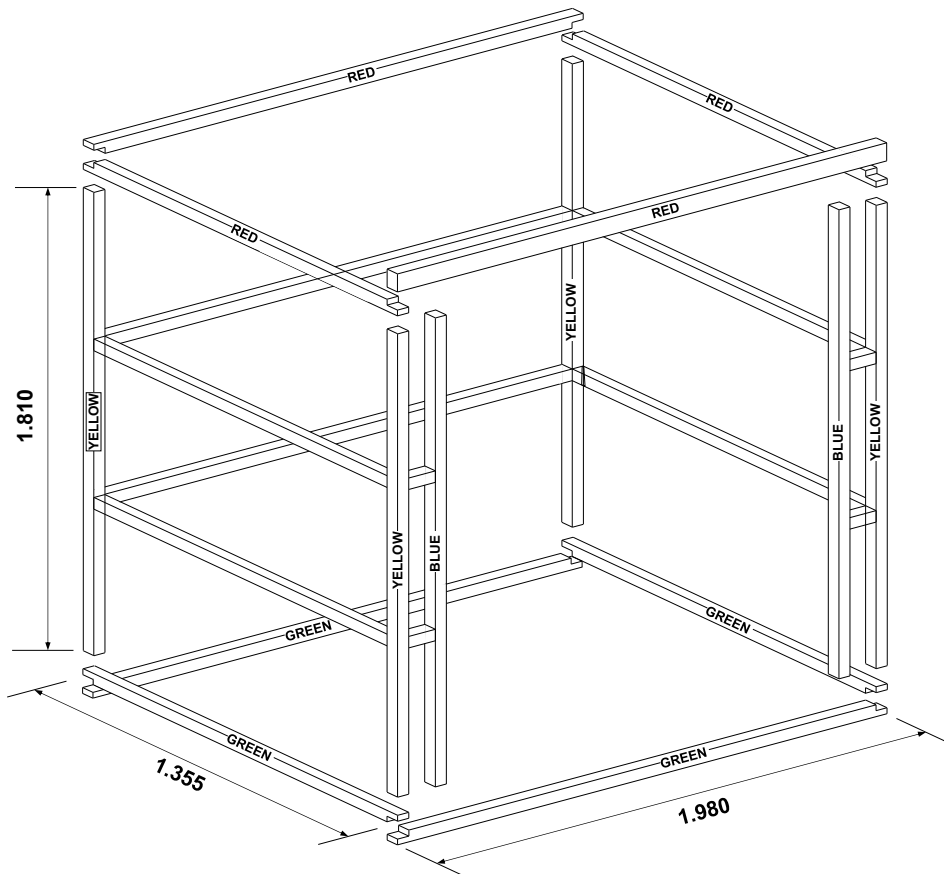

**Note:** For sheds being positioned on a Purpose Built Floor, shorten Studs by 30mm now (Refer to Floor Section).

**Step 1:** Select one End Base Plate 1.355m (Green), one End Top Plate 1.355m (Red) and two Studs (Yellow). Lay out on flat surface and nail together using two 75mm nails per joint (**fig. 1**). Evenly space two End Wall Nogs between Studs and nail in place. If fitting a seat in this shed, place bottom nogs so that the bottom of the nog is .400 up from the bottom of the base plate. Repeat with the other end frame.

**Step 2:** Select Back and Front Base Plates 1.980m (Green), Back Top Plate 1.980m (Red) and Front Top Plate (90x45mm). With one End Frame lying on the ground, nail plates to frame, two 75mm nails per joint. Ensure Green joins to Green and Red joins to Red. See (**fig. 2**) for nailing detail on Top Front Plate (90x45mm).

**Step 3:** Position remaining End Frame on top of plates. While someone supports frame, nail in place using two 75mm nails per joint.

**Step 4:** Carefully roll frame over onto its base. Nail on Back Wall Nogs evenly between Top and Bottom plate (this may be easier if the frame is rolled onto its Back wall). Nail Front Wall Studs (Blue) using Front Wall Nogs to get correct position, Nail remaining Front Wall Nogs in evenly (this may be easier if the frame is rolled onto its Front wall).

**Step 5:** Fit front Top Plate Flashing centrally on Front Top Plate using four 30mm Clouts. Note—flashing to protrude past Top Plate by 10mm each end. Position Flashing so that the widest lip is on top.

1

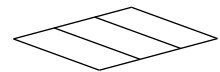

2

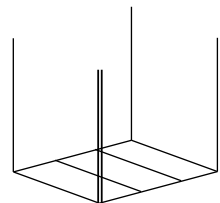

3

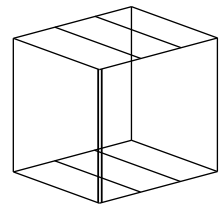

4

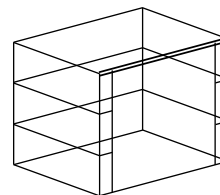

5

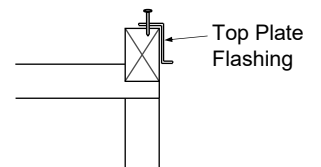

# WS400 WALL CLADDING

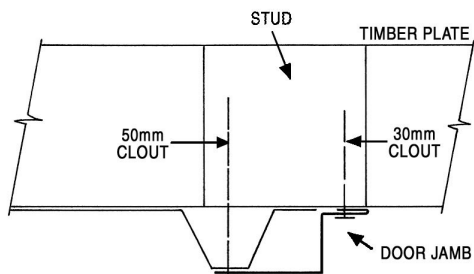
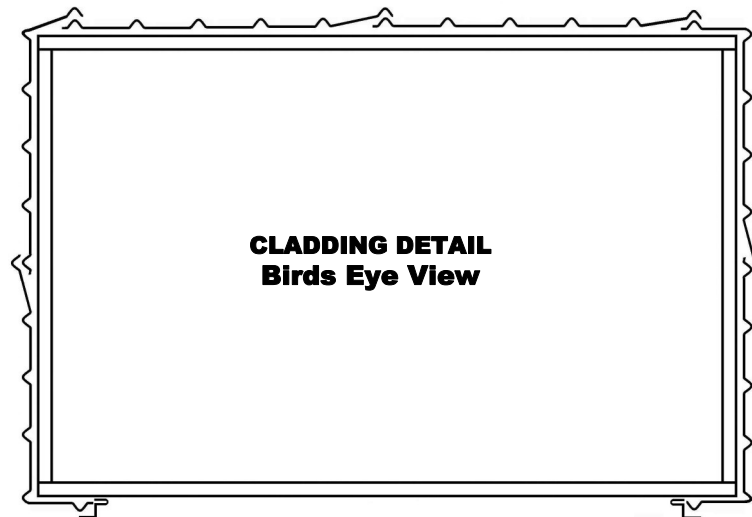

fig. 1

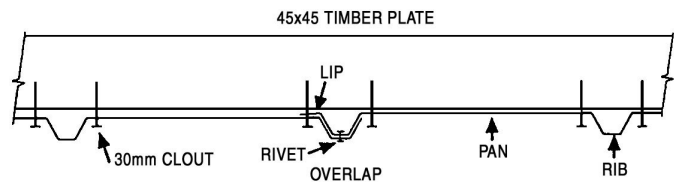
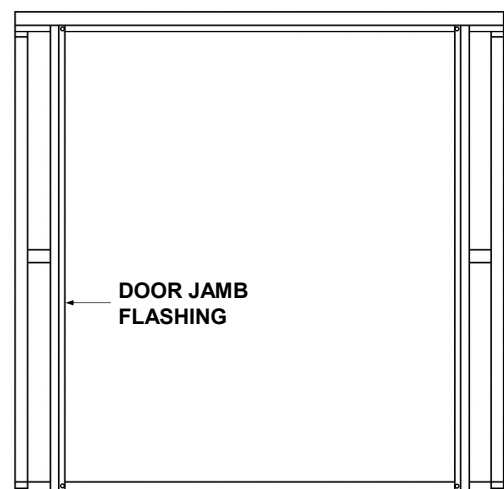

fig. 2

## To Avoid Corrosion:

Where at all possible try not to trap metal filings between two sheets. Remove all metal filings before riveting. Carbon in pencils reacts with the Zinc/Aluminum coating on steel. Use ink to mark steel.

**Step 1:** Door Jambs: Position left hand Door Jamb Flashing so it lines up with door way stud and nail to Top Plate and Bottom Plate using a 30mm clout. Do not fit 50mm nails at this stage. Pre-drill holes to make nailing easier (**fig. 1**).



FRONT VIEW



# WS400 WALL CLADDING

**Step 2: NOTE:** It is very important that the Wall Sheets are positioned exactly as shown in the **cladding detail** diagram on the previous page.

Position Corner Wall Sheets. Check that the Lip is on the correct side of the sheet. While holding Corner Wall Sheet flush with the top of the Top Plate, nail to plate using only one 30mm clout top and bottom.

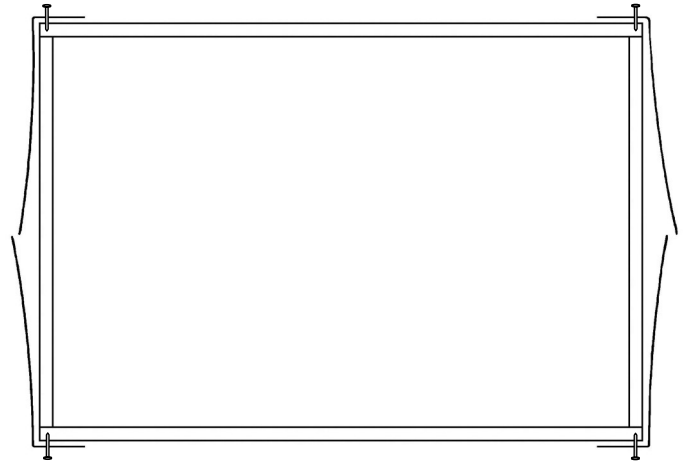

Birds Eye View

**Step 3:** Nail remaining Wall Sheets on ensuring lips are positioned as they are in the **Cladding Detail** and tops of sheets are flush with top of Top plate.

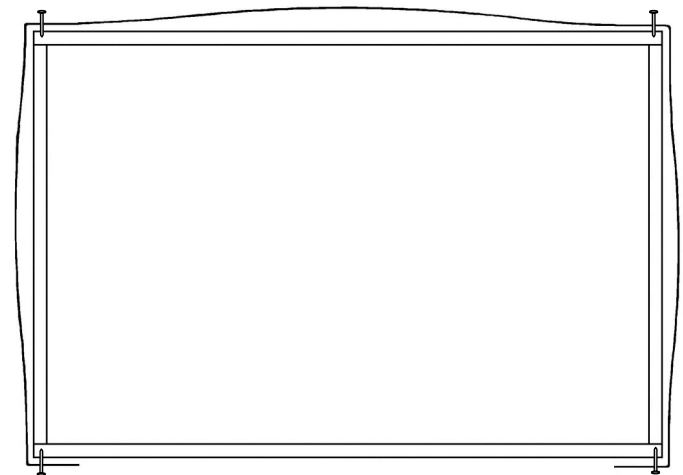

↑ = 30mm Clout

**Step 4:** Nail Wall Sheets to Plates, two 30mm Clouts per pan top and bottom.

Nail Wall Sheets to Wall Nogs, one clout per pan.

**Step 5:** Drill a hole through Door Jamb Flashings and Wall Sheets top and bottom. Nail with 50mm nails (**fig. 1**).

Nail left hand Door Jamb Flashing to Stud using three 30mm Clouts at equal spacings (**fig. 1**). Beside each 30mm Clout, rivet Door Jamb Flashing to Rib. Repeat with right hand Door Jamb Flashing.



# WS400 ROOF

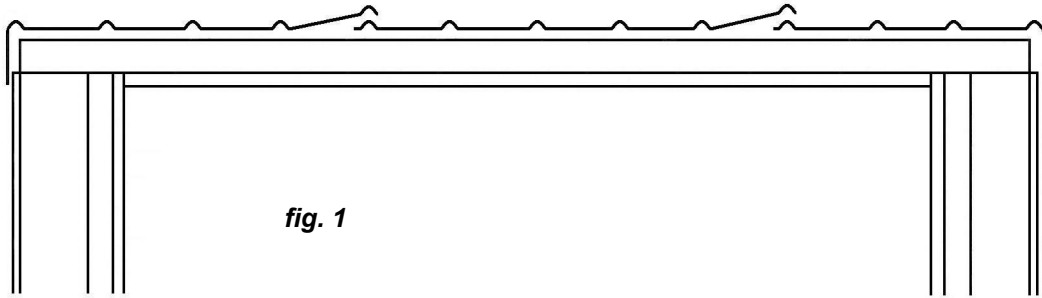

**Step 1: Note:** Condensation can form on the under side of shed roof. If building paper is required, fit now. Building paper will need to be supported by netting or roofing twine.

Position Roof Sheets as shown in **fig 1**. Make sure sheet joins at the back are flush. Rivet sheet joins, one rivet 200mm back from edge front and back. Fit one more rivet in centre of each join.

**Step 2:** Position Roof so that the front overhang measures 450mm. Rivet roof to wall sheets using one rivet every second Rib. Repeat at the other end ensuring overhang measures 450mm.



**Step 3:** Line up ribs on the roof with ribs on the walls. While someone holds the Front Plate straight, predrill using a 3.5mm drill bit and screw the roof to Top Plate using one 55mm Roofing Screw on each rib. (Outside ribs do not need to be fastened). Repeat at the back.

Note: a string line can be used to make this easier.

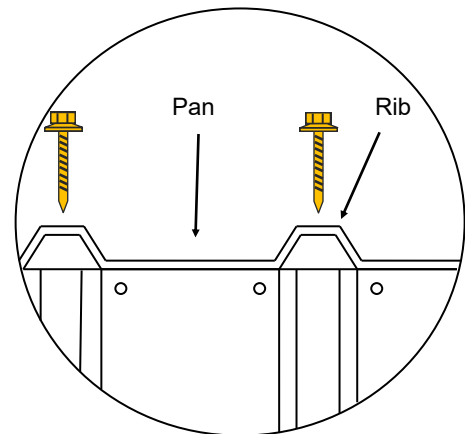

**Step 4:** Fit Roof Flashing as shown. When positioned correctly rivet through Roof Flashing into Roof Sheet joins.

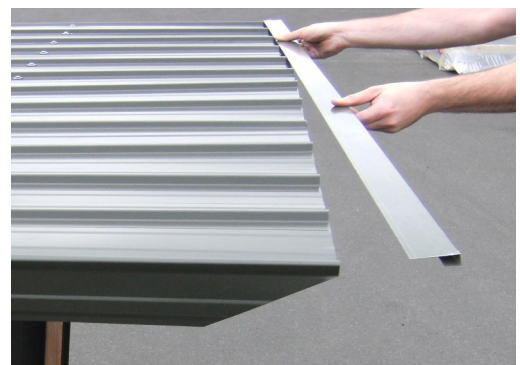



# WS400 FLOOR (Optional)

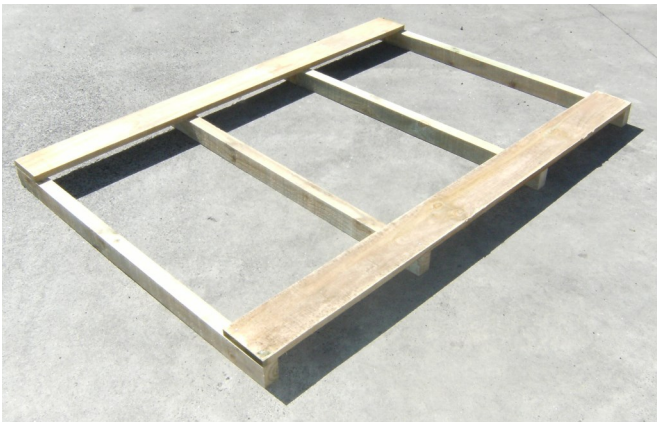

**Step 1:** Position two Floor Boards at front and back of the four bearers provided. Nail one 50mm nail into each corner. Check Floor is square by measuring diagonals. Once square put another nail in each end of the boards to hold position.



**Step 2:** Lay out remaining Floor Boards evenly allowing small gaps between boards for air circulation. You may need to cut the last board to width using Skill Saw. Nail in each Floor Board, two 50mm nails each end and two into each Floor Joist.

**Step 3:** Place Shed on top of Floor and screw Shed to Floor using eight 75mm screws

# SHELTER BENCH

**Step 1:** Make centre Brace by selecting two Brace Verticals (310mm) and two Brace Horizontals (405mm) and screw together with 75mm screws as shown

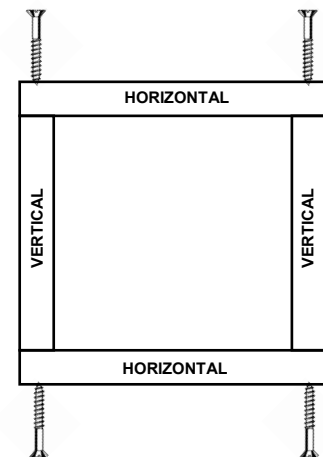

**Step 2:** Place three Seating boards on lower side nogs, hard against the back studs. Place Centre Brace centrally under Boards.

Screw each Board to nogs and Brace with two 75mm screws at each end and into Brace.

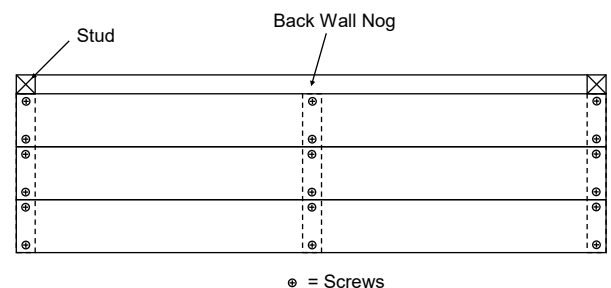

**Step 3:** If you have installed a Floor screw bottom of Brace into Floor with two 75mm screws.

# PURPOSE BUILT FLOOR

*i.e. CONCRETE / PLYWOOD*

For sheds being placed on a purpose built floor, we recommend that the studs are shortened by 30mm. The Wall Sheets will then protrude 20mm below the Base Plate. This will stop water flowing in between the Base Plate and Floor.

If you choose this option, the Floor should be made 15mm smaller than Base Size.

**Note:** Although it is not essential, fitting Damp Proof Course in between the Base Plate and the Floor will give added protection against moisture.

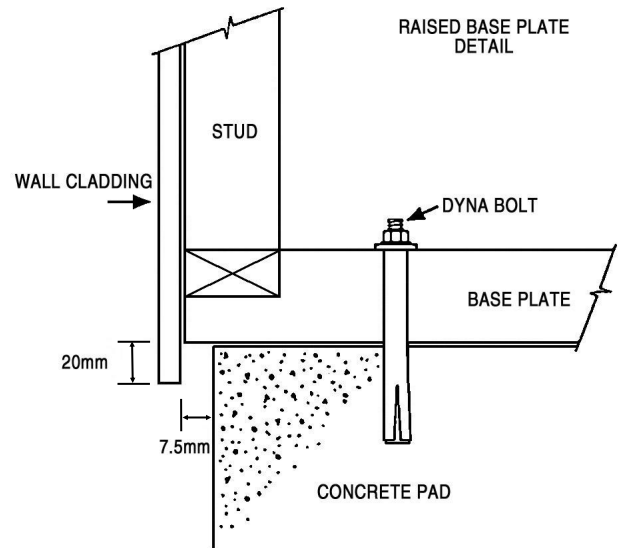

## CLEAN UP

- Remove all metal filings with a soft brush or rag.
- Hose down roof and walls thoroughly.

## PAINTING

- Painting Zinc/Aluminium coated steel will extend its life in most environments
- The surface must be dry and free of dirt, oil, grease and other contaminants prior to painting, but no weathering of the surface is required
- Zinc rich primers are recommended for use, along with a two coat finishing system. Paint suppliers should be consulted for the most suitable paint system to ensure compatibility of primers and topcoats.

## DURATUF PREMIUM SHED WARRANTY

### GUARANTEE TO CUSTOMER

Congratulations on purchasing a Duratuf Storage Shed. With proper care and attention, this product will last many years.

For your benefit **PLEASE READ THE FOLLOWING INFORMATION CAREFULLY.**

### WARRANTY ON METAL CLADDING

Riverlea Group Ltd guarantee that the metal roofing and wall cladding on Kiwi and Fortress Garden Sheds may be used in moderate and inland corrosion zones or areas where the first year mild steel corrosion rate is less than 200g/m<sup>2</sup>, and that in these conditions, they will not perforate due to corrosion within 30 years of date of manufacture.

### TERMS AND CONDITIONS

1. Damage or corrosion due to the following circumstances is not covered by this warranty.
  - ◆ Mechanical, chemical or other damage sustained during or after installation.  
**NOTE:** Clean swarf off shed **IMMEDIATELY** after assembly  
Do **NOT** mark cladding with pencil  
Do **NOT** allow manures, chemicals or other corrosive materials to have direct contact with cladding  
Chemical damage will result if these instructions are not carried out
  - ◆ Force majeure or other causes beyond the control of Riverlea Group Ltd.
2. This warranty does not cover material installed in severe and very severe environmental situations, or in any area where the mild steel corrosion rate (as published by BRANZ) exceeds 200g/m<sup>2</sup>.
3. Minimum maintenance must be carried out in accordance with instructions below.

Should the cladding fail to perform as specified above, the liability of Riverlea Group Ltd shall in all cases be limited to replacing or repairing the defective product. The balance of the original warranty will cover any repaired or replaced material. Riverlea Group Ltd will not be liable for any consequential loss or damage, labour or transport charges. All claims made in writing within 21 days of discovery, quoting the reference number at the top right hand corner of this page.

### MAINTENANCE

Following are the minimum maintenance requirements for cladding used in Kiwi Garden Sheds and Fortress Sheds.

- ◆ Washing all surfaces by rain, and annual hosing of sheltered areas using a hose and soft nylon brush.
- ◆ Within 2km of coast—wash every 3 months as above. After a storm, wash the cladding and the gutters as soon as possible to remove any highly corrosive salt deposits.
- ◆ Volcanic Ash Fallout—wash as soon as possible, removing fallout from roof and gutters
- ◆ Gutters to be kept clean of leaves and dirt.

Should you require additional technical information please contact us at the details below.

## WARRANTY REGISTRATION

Please visit [www.duratuf.co.nz/warranty](http://www.duratuf.co.nz/warranty) to validate the Warranty on your shed.

Click on the Warranty Registration Link and complete all details.

If you are unable to access the computer, please phone us on 0800 438 274 and one of the customer services team will help you to activate the warranty on your garden shed.

*Many thanks, from the Team at Riverlea Group.*



**COMPLETE OUR CUSTOMER SURVEY**

## **Thank you for investing in a Duratuf Garden Shed.**

We are sure that it will provide excellent long-term storage and add value to your property. To continually improve our products and service, we would love to hear about your Duratuf experience and why you chose us.

Further to that, we would also love to see a picture or a short video of your shed installed and doing its job so that we can share this with others for their inspiration. Thank you in advance and we look forward to receiving your feedback!

To complete the survey please visit  
**[www.duratuf.co.nz/customer-survey](http://www.duratuf.co.nz/customer-survey)**