



Quality - Built In

ASSEMBLY INSTRUCTIONS



KL2

BASE SIZE 2545mm x 1210mm

CHECK OUT OUR ASSEMBLY VIDEO

Let Keith and Justin show you how to build your Kiwi shed like a professional.

When used in conjunction with these assembly instructions, Keith's practical tips and tricks will make your assembly experience that much simpler, giving you visual guidance through sections that seem tricky on paper, and help you achieve a flawless end result.

To view the video visit www.duratuf.co.nz/kiwi-assembly



Note: Assembly video features a MK2. But can be used for reference for any other Kiwi model.

ASSEMBLY INSTRUCTIONS

Tools Required:

- Drill
- Drill Bit 3.5mm
- Drill Bit 6mm (for clear roof sheet only)
- Hex Drive 5/16
- Riveter
- Hammer
- Nail Punch
- Tape Measure
- Ladder or Saw stool
- Spanners x 2
- String Line
- Tin Snips
- Skillsaw and Jigsaw (for floor only)
- Masonry Drill and 10mm Masonry Bit (for Bolt Down Kit only)

IMPORTANT

SUNSCREEN WARNING: Prevent contact of the painted surface with sunscreens containing titanium dioxide (TiO₂) or zinc oxide (ZnO). It has been proven to discolour and degrade the paint finish. The use of gloves is recommended.

Damage to prepainted steel caused by contact with sunscreen is not covered by your Duratuf warranty.

Before you start:

- Read all instructions carefully.
- Identify all parts and check quantities against checklist.
- If you are making your own floor refer to Raised Base Plate section now.
- Before assembly, remove protective film where present from all flashings and coloured steel components.

Safety:

- Do not attempt to build your shed in high winds.
- Beware of sharp edges.
- Protect your eyes and ears.
- Use electric tools with care. Use a Safety Trip Switch.

Select your site:

- It is easier and quicker if this shed is erected by two people.
- Your shed must be level. Achieve this by either levelling the ground or by using blocks.
- If your shed is to be positioned on wet or damp ground, we recommend that your shed is raised up off the ground slightly.

ROOF COLOUR WALL COLOUR INVOICE NO: BASE SIZE:

QTY	LENGTH	DESCRIPTION	PACKED	CHECKED
			<input type="checkbox"/>	<input type="checkbox"/>
7	1.890m	Wall Sheets	<input type="checkbox"/>	<input type="checkbox"/>
2	1.890m	1/2 Wall Sheets	<input type="checkbox"/>	<input type="checkbox"/>
3	1.450m	Roof Sheets	<input type="checkbox"/>	<input type="checkbox"/>
1		Door - Standard <input type="checkbox"/> Security <input type="checkbox"/>	<input type="checkbox"/>	<input type="checkbox"/>
1		Instruction Booklet	<input type="checkbox"/>	<input type="checkbox"/>
1		Hardware Pack	<input type="checkbox"/>	<input type="checkbox"/>
		Touch-up Paint & Brush	<input type="checkbox"/>	<input type="checkbox"/>
1		Duratuf Riveter	<input type="checkbox"/>	<input type="checkbox"/>
			<input type="checkbox"/>	<input type="checkbox"/>
			<input type="checkbox"/>	<input type="checkbox"/>
			<input type="checkbox"/>	<input type="checkbox"/>
			<input type="checkbox"/>	<input type="checkbox"/>
			<input type="checkbox"/>	<input type="checkbox"/>
			<input type="checkbox"/>	<input type="checkbox"/>
			<input type="checkbox"/>	<input type="checkbox"/>

OPTIONAL EXTRAS

QTY	LENGTH	DESCRIPTION	PACKED	CHECKED
100	50mm	Flooring Nails	<input type="checkbox"/>	<input type="checkbox"/>
6	75mm	Flooring Nails	<input type="checkbox"/>	<input type="checkbox"/>

WINDOWS

		Fixed Window Frame	<input type="checkbox"/>	<input type="checkbox"/>
	0.580m	Glaze Beads	<input type="checkbox"/>	<input type="checkbox"/>
	0.603 x 0.603m	Glass	<input type="checkbox"/>	<input type="checkbox"/>
			<input type="checkbox"/>	<input type="checkbox"/>
		Louvre Window Frame	<input type="checkbox"/>	<input type="checkbox"/>
	0.588 x 0.150m	Glass	<input type="checkbox"/>	<input type="checkbox"/>
1		Window Hardware Pack	<input type="checkbox"/>	<input type="checkbox"/>
			<input type="checkbox"/>	<input type="checkbox"/>

CLEAR ROOF PANEL

	1.450m	Clear Roof Sheet	<input type="checkbox"/>	<input type="checkbox"/>
	1.450m	Roof Sheet	<input type="checkbox"/>	<input type="checkbox"/>
			<input type="checkbox"/>	<input type="checkbox"/>
			<input type="checkbox"/>	<input type="checkbox"/>
			<input type="checkbox"/>	<input type="checkbox"/>

SECURITY PARTS

		Security Single Door Hardware Pack	<input type="checkbox"/>	<input type="checkbox"/>
		Alarm - MA20	<input type="checkbox"/>	<input type="checkbox"/>
		Shed light	<input type="checkbox"/>	<input type="checkbox"/>
		Bolt Down Kit	<input type="checkbox"/>	<input type="checkbox"/>
		Peg Down Kit	<input type="checkbox"/>	<input type="checkbox"/>

DATE: / /

Total Weight kg

PACKED BY:

CHECKED BY:

KL2 TIMBER FRAME

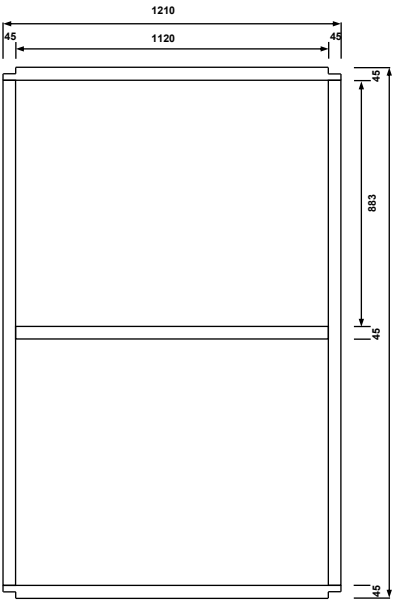
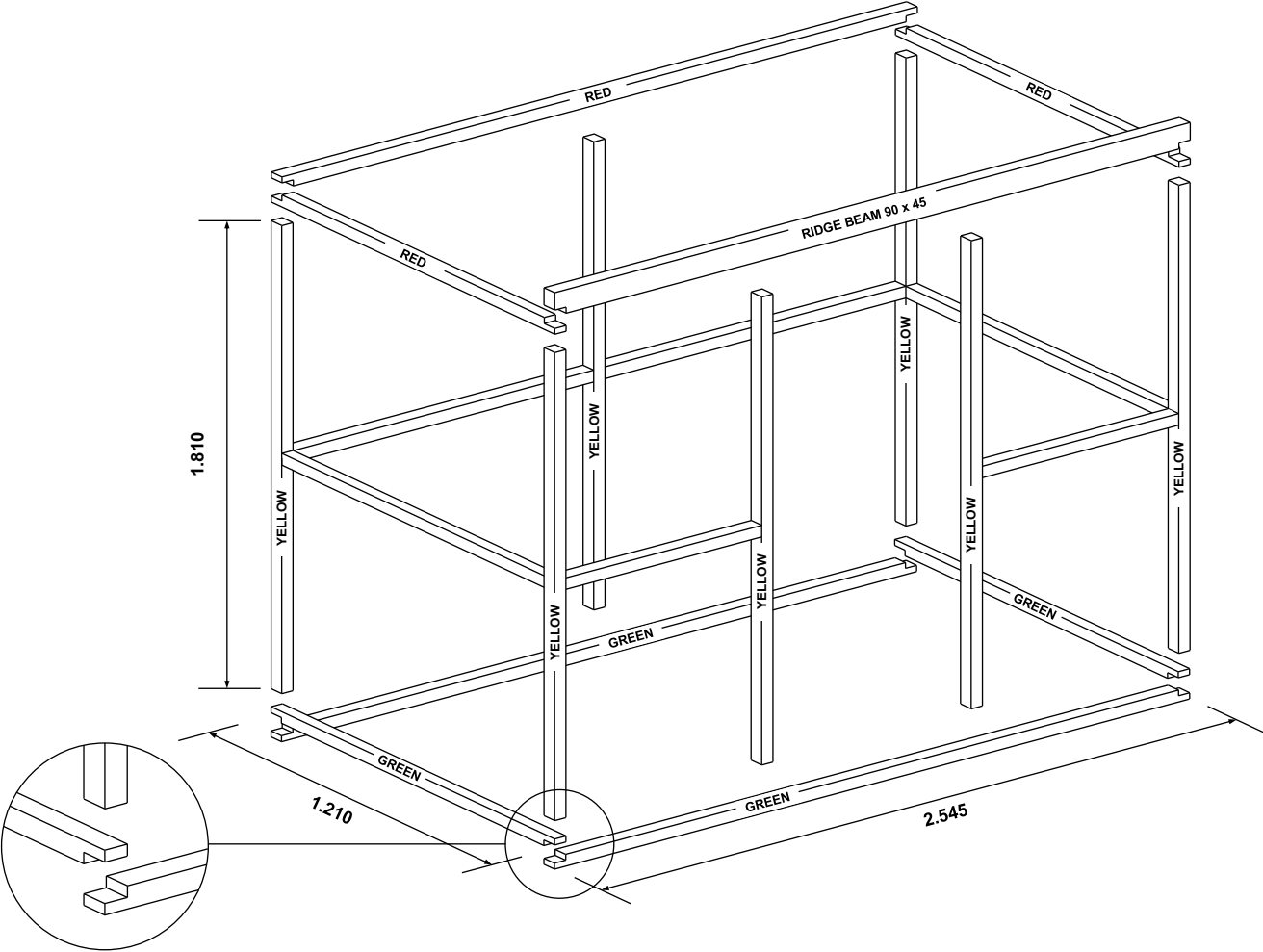

END WALL

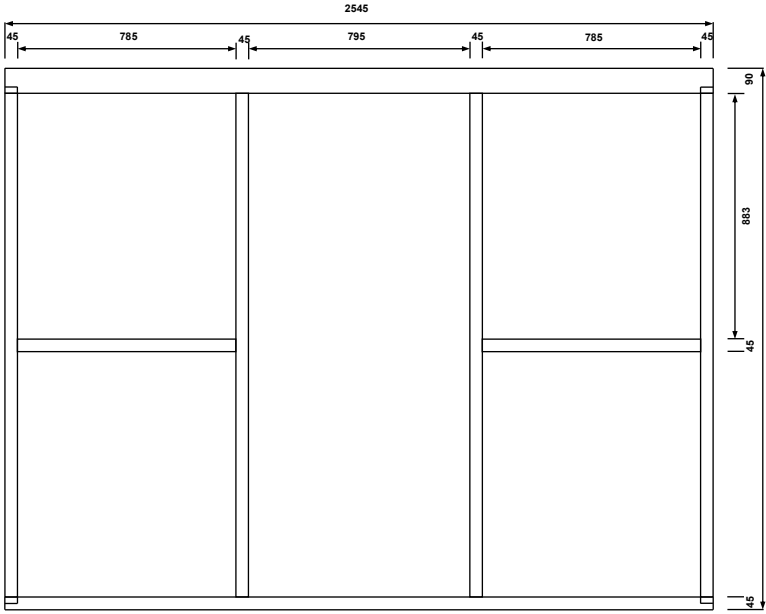

FRONT WALL

KL2 TIMBER FRAME

Note: For sheds with the Raised Floor Modification option the studs will be 1.780m long to allow the Wall Sheets to protrude 20mm below the Bottom Plate. Refer to Raised Floor Modification section (Page 15).

Note: If fitting a window in the Back Wall, there will be no centre stud on that side. Instead nail in a full length Nog (2.455) using Window Studs (.883) to get correct height. Position one Window Stud centrally beneath the Nog and nail in place. Further window studs and Nogs are fitted after the cladding is on.

Step 1: End Walls: Select one 1.210m End Base Plate (Green), one 1.210m End Top Plate (Red) and two Studs (Yellow). Lay out Plates and two Studs on a flat surface and nail together using two 75mm nails per join. Position 1.120m Nog .883m down from Top Plate and nail in place. Repeat with other end wall.

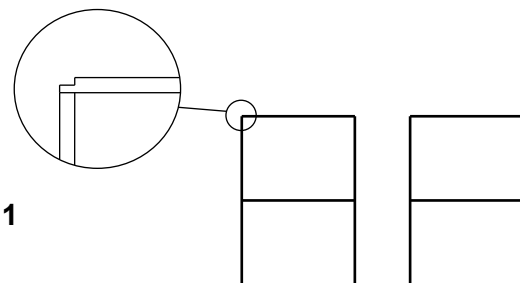

Step 2: Select one 2.545m Base Plate (Green), one 2.545m Top Plate (Red). Stand up End frame with the Stud side of the frame on the ground. Nail 2.545m plates to frame using two nails per join. Ensure Green joins to Green and Red joins to Red. Repeat with other end frame. Nail in back wall centre stud using 1.205m Nogs to get correct position. Position Nogs .883m down from Top Plate and nail in place.

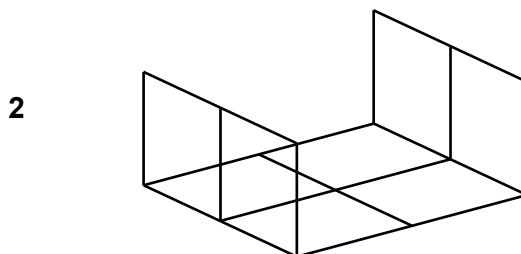

Step 3: Select one 2.545m Base Plate (Green) and the Ridge Beam (90 x 45). Nail in place. Ensure Green joins to Green.

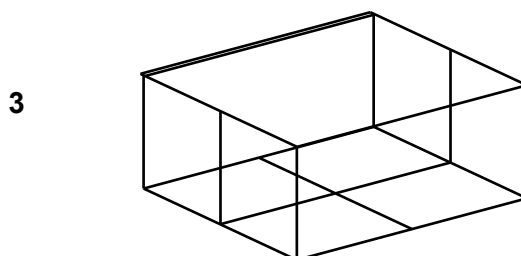

Step 4: Carefully roll the frame over so that the Ridge Beam and Base Plate (Green) are on the ground. Select two studs (Yellow) and two .785m Nogs. Nail in Studs using the .785m nogs to get the correct position top and bottom. Position nogs .883m down from the Top Plate and nail in place.

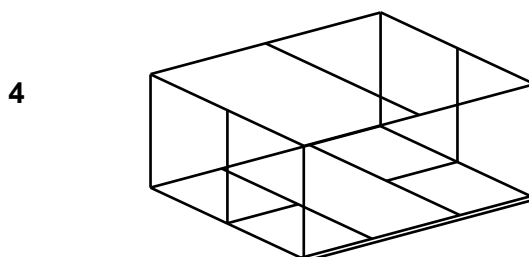

Step 5: Carefully roll frame over onto its base. If fitting a Kiwi Floor, fit Floor Joist now. Place the joist centrally and nail in place using three 75mm nails per end.

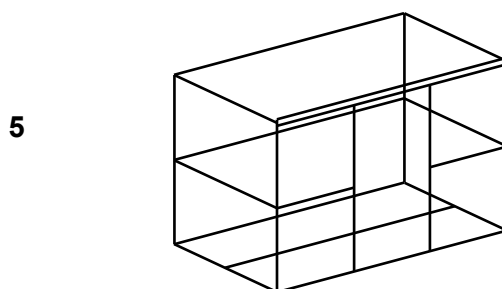

KL2 WALL CLADDING

TO AVIOD CORROSION:

- Where at all possible try not to trap metal filings between two sheets. Remove all metal filings before riveting.
- Carbon in pencils reacts with the Zinc/Aluminium coating on steel. Use either crayon or ink to mark steel.

TERMS EXPLANATION

- **To Tack:** To Tack on a wall sheet means to use minimum nails hammered partly in to hold Wall Sheets in position. Should a Wall Sheet need to be re-positioned, the nails can easily be prized out.
- If a window is required, identify Wall Sheet(s) with window hole pre-cut. Lean up Wall Sheets where window(s) are to be located.

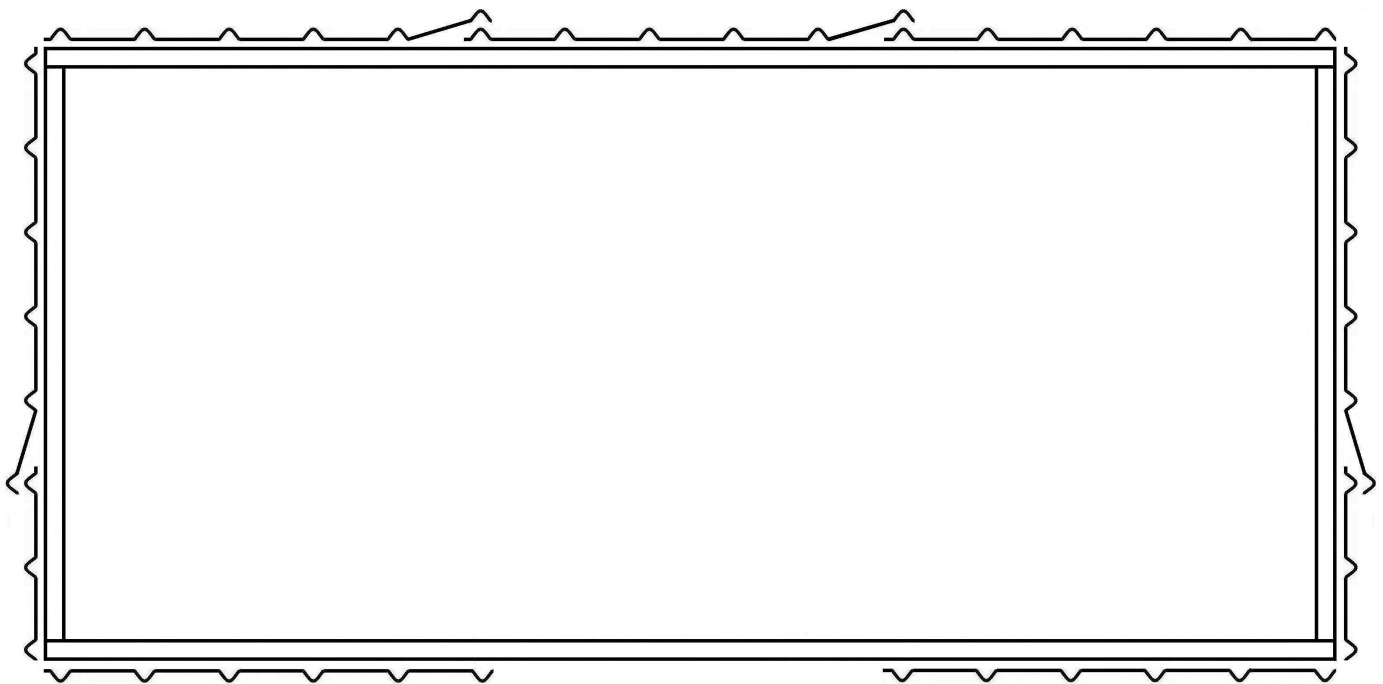

CLADDING DETAIL
Birds Eye View

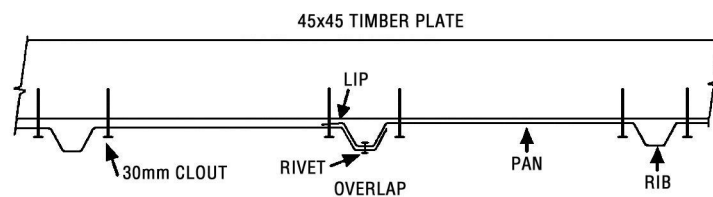
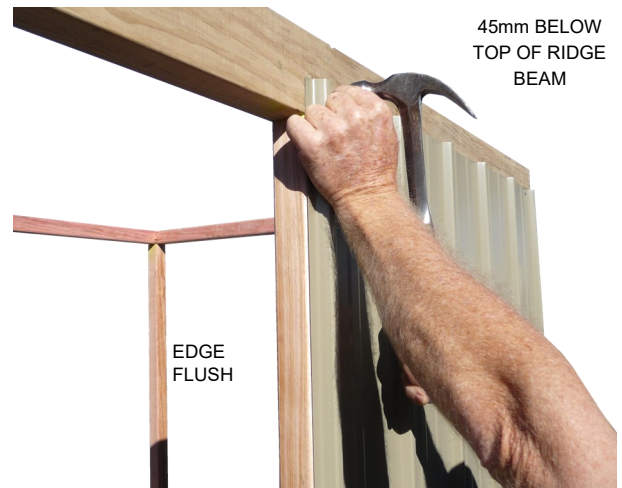

fig. 1

KL2 WALL CLADDING

Step 1: Front Wall: Position first wall sheet on the left hand side of the doorway with the sheet LIP on the left hand side. Ensuring the LIP is flush with the side of the corner Stud and the top is 45mm below the top of the Ridge Beam, tack in place. Repeat on other side of doorway.



Step 2: Back Wall: Position the first Wall Sheet with the LIP on the right hand side. Ensuring the LIP is flush with the side of the corner Stud and the top of the Wall Sheet is flush with the top of the Top Plate, tack in place. Position the next Wall Sheet with the LIP on the right hand side. Overlap as shown in **fig 1**. Ensuring Wall Sheet is flush with top of Top Plate, tack in place. Repeat with remaining Wall Sheet.



Step 3: End Walls: Position wall sheet with the LIP flush with the side of the stud and the top of the Wall Sheet is flush with the top of the Top Plate, tack in place. Tack in remaining 1/2 Wall Sheet. Repeat with the other end. If fitting a window, nail in Window Studs and Nog now. Refer to Window instructions.

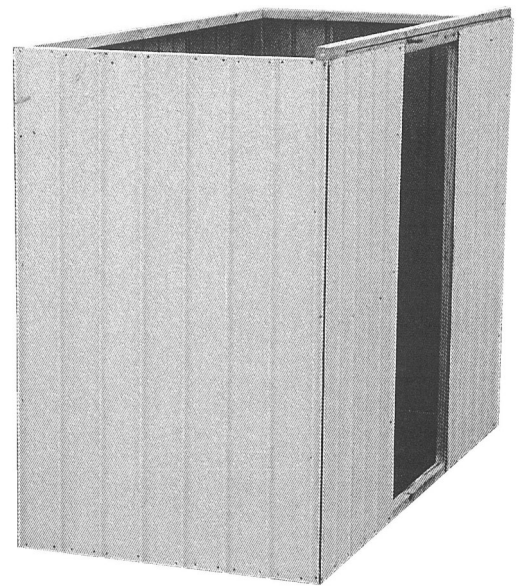

Step 4: Nailing Off: Nail one 30mm Clout each side of the Rib (two per Pan) into the Top Plates and Bottom Plates. Nail Wall Sheets to mid wall Nogs (one per pan). Nail each corner Wall Sheet to Studs using two 30mm Clouts evenly spaced.

KL2 WINDOW (Optional)

LOUVRE WINDOW

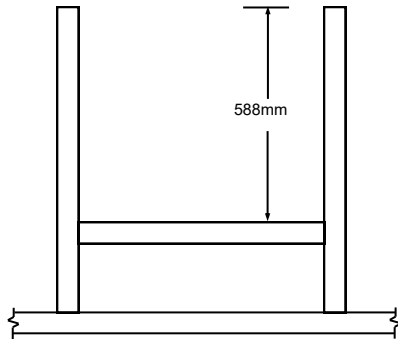

Step 1: Lay out the two window studs (883mm) and Nog (634mm) on a flat surface. Position Nog and nail in place using 2x 75mm nails at each end.



Step 2: On the inside of the shed, position studs and Nog centrally on window opening. Make sure the studs are parallel and nail into Top Plate and End Wall Nog.

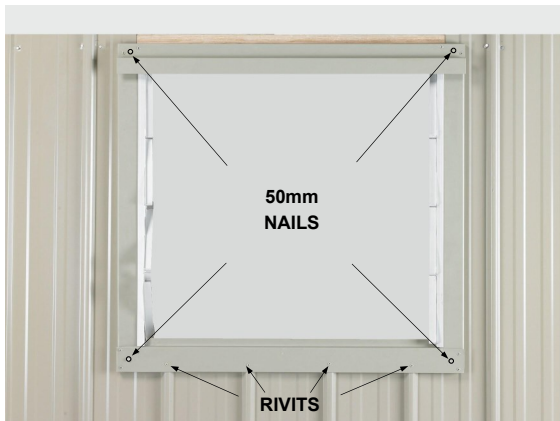

Step 3: Nail wall Sheets to window framing using 30mm clouts. (return to step 4 on page 7 and complete). Then fit Window Frame). Position Window Frame centrally on window opening and rivet it to ribs. Pre-drill holes in each corner and nail Window Frame to framing, using 50mm nails.



Step 6: From the inside of the shed, slide Louvre Glass into Louvre Units attached to the Window Frame. Bend up tabs to keep Glass in position.

FIXED WINDOW

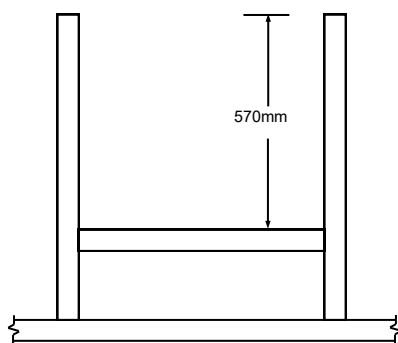

Step 1: Lay out the two window studs (883mm) and Nog (590mm) on a flat surface. Position Nog and nail in place using two 75mm nails at each end.



Step 6: From the outside of the shed, place glass in Window Frame. Attach a Glazing Bead (G100) with three rivets to each side of the Window Frame to hold glass in place. Pre-drilling Glazing Beads is recommended.

KL2 DOOR JAMB & CORNER FLASHINGS



Step1: Fit Door Jamb Flashing (104) in between Top and Bottom Plates and hard against Stud. Attach Door Jamb Flashing with three rivets into Rib on the outside and three 30mm clouts into studs on the inside. Repeat with the other Door Jamb.



Step2: Measure and cut Doorstep Flashing (106) to fit in between Door Jambs. Position the Doorstep Flashing in between the Door Jambs at bottom of doorway, nail through top of flashing using three 30mm Clouts. Repeat with the Overdoor Flashing (105).



Step 3: Fit the four Corner Flashings over the corner Ribs, with their tops flush with the top of the cladding, and rivet in place using six rivets per flashing. When fitting right hand Corner Flashing on the front wall, ensure it is parallel with the Door Jamb.

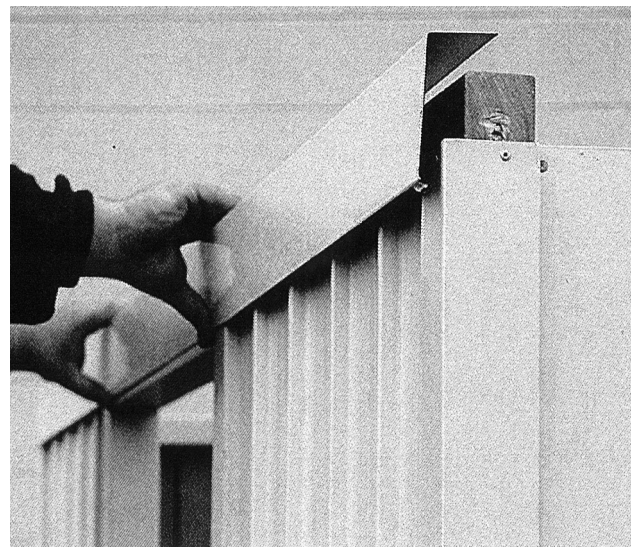

Step 4: Position Front wall flashing (A109) on Ridge Beam. While holding straight and square, nail top of Front wall flashing to Ridge Beam using four 30mm clouts. Rivet front of Front wall flashing to Ribs and Flashings using ten rivets.

KL2 DOOR

Step 1: Position Door Track (107) on the front wall 45mm down from underside of Roof, with right hand end 20mm in from outside edge of right-hand corner flashing. Pre - drill hole in centre of track and screw in place using, one 45mm door track screw. Remove ALL drill filings.

Note: Ensure Door Track screws are screwed in horizontal and screwed hard into flashing. Protruding screw heads can cause door rollers to bind on the screw heads.

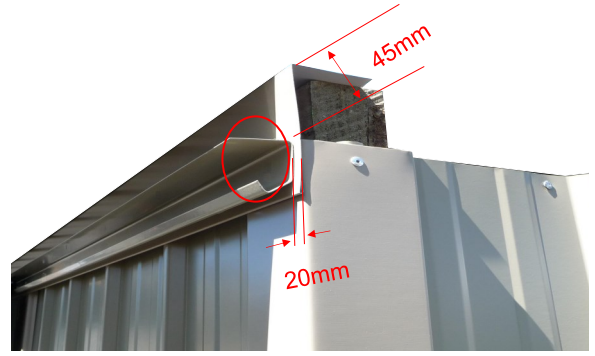

Step 2: Hang door in the Door Track. At the right hand end of Door Track, adjust up or down so that the Door hangs parallel with shed. Fit one rivet at right hand end to hold in place. Repeat with left hand end of track.

Note: Only use rivets at each end of track.



Step 3: Remove the Door. Pre-drill and screw another 2 screws between centre screw and the rivets at each end (5 screws per track). Screw track using 45mm door track screws.

Step 4: Clean out ALL drill filings. Also make sure the Wheels are cleaned of drill filings. Re-hang Door.

Door Stops: Pre-drill a hole in right-hand end of track, 45mm in from outside edge of Corner Flashing.

Pre-drill hole in left-hand end of track, 45mm from outside of door jamb. (60mm for Security door option.)

Screw door stops in using 1 x Roofing screw per stop.

Check door doesn't protrude past outside edge of shed.



KL2 DOOR

Step 5: Bottom Door Guide: Slide the Door to the corner of the shed. Place the Door Guide (108) over the Guide Brackets on the door and align the end of the Door Guide 20mm in from outside of the right-hand corner flashing.

Step 6: Lift the door guide up approximately 3mm so that the Door will Slide freely. Pre-drill a hole through the door guide and the end rib of the cladding and screw in place using a 45mm screw.

Step 7: Slide the door to the centre, ensuring that it slides freely. Pre-drill and insert a screw in the other end of the Door Guide. Check that the Door is not binding in the middle then pre-drill and fix with 3 more screws, one in the centre of the guide and the other 2 evenly spaced between (5 screws per guide) into the door step flashing and rib.

Note: For sheds with Raised Base Plate option the Door Step Flashing will protrude down past the Bottom Plate. Attach Door Guide with rivets.

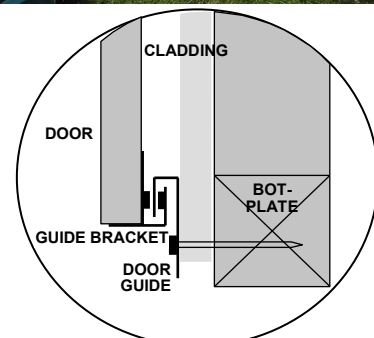

KL2 ROOF

Note: Condensation can form on the under side of shed roof. If building paper is required, fit now. Building paper will need to be supported by netting or roofing twine.

Roof with Clear Roof Sheet: Handle Clear Roof Sheet with care. The Clear Roof Sheet will crack if not fitted correctly.
Riveting: Pre-drill 3.5mm hole through Clear Roof Sheet and Steel. Enlarge hole in Clear Roof Sheet with drill to allow for expansion and contraction.

Screwing: Pre-drill a 6mm hole through the Clear Roof Sheet.

Step 1: Check that the diagonal measurements of the shed are the same. If building on unlevel ground it may be necessary to temporarily brace the shed with pieces of timber from the packaging.

Step 2: Position first Roof Sheet on the right hand side of the shed with the LIP on the left hand side. Position the next Roof Sheet. Ensure it overlaps correctly (when fitting a Clear Roof Sheet, ensure it OVERLAPS Roof Sheet). Rivet sheet joins 500mm from edge, front and back. Position and rivet remaining sheet.



Step 3: Position roof so that the front overhang measures 140mm. Line up Ribs on the Roof Sheets with Ribs on the Wall Sheets. Ensure plates are straight then screw roof to Top plates using one 50mm Roofing Screw on each Rib front and back.

(Using 4 x 50mm galv clouts, nail clouts on the outside ribs only, as these are covered by the Barge flashing.

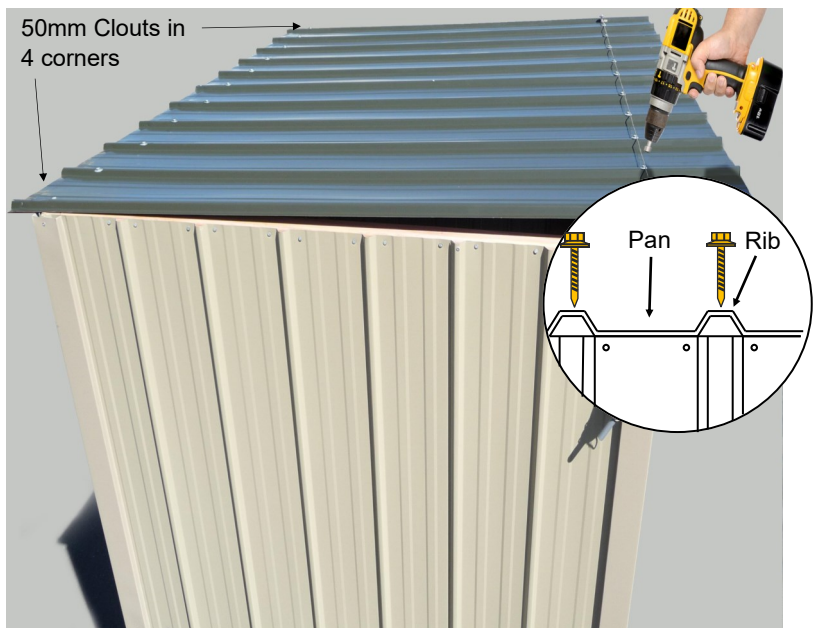

KL2 BARGE & SPOUTING

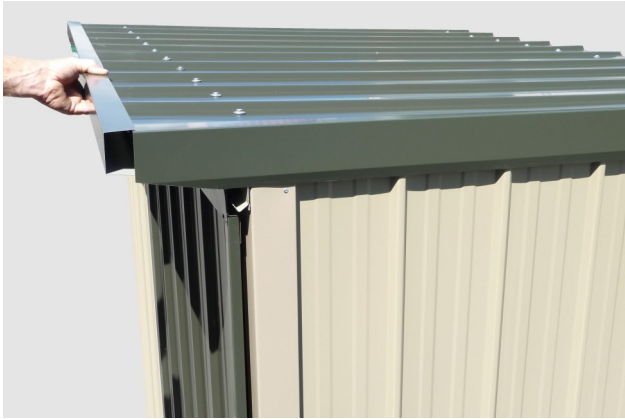

Step 1: Position Barge Flashing (G102) on gable ends. Position a Spouting (A103) and rivet to the Barge Flashing at each end. Repeat with other Spouting.



Step 2: Centralise Barge Flashing on end and rivet in place, one rivet into every second Rib. Fit two rivets through top of Barge into Rib. Repeat with other Barge Flashing. Check Spoutings are straight, then rivet to Roof one rivet every second Rib.

KL2 FLOOR (Optional)

Step 1: Place shed in final position. Check the diagonal measurements are the same and the shed is level before fitting Floor. It is recommended that the shed is anchored down with either a Duratuf Bolt Down Kit or Duratuf Peg Down Kit depending on what the shed is sited on.

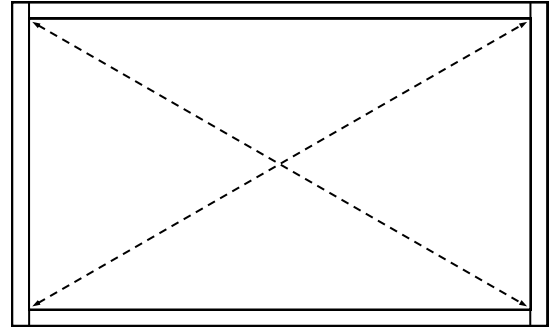

Step 2: Lay a Floor Board on top of Bottom Plates and Joist and push up against end wall. Mark out where Studs are. Cut checkouts with Electric Jigsaw so Floor Board will fit around Studs.



Step 3: Re-position Floor Board. Lay out remaining Floor Boards checking around Studs as you go. The last Floor Board may have to be cut to size.



Step 4: Nail in each Floor Board, two 50mm nails in each end and two into Joist. Measure and cut Floor Flashing (110) to fit in between Door Jamb Flashings and nail in place using 50mm Clouts.



KL2 HASP & STAPLE



Using six rivets and one 50mm clout attach hasp to Door Jamb Flashing and the staple to the Door as shown.

(Note: See below for security option.)

SECURITY DOOR (Optional)

Step 1: Attach "T" locking handle with two 8x10mm screws. Slide hook onto square shaft and secure with a lock washer.

Lock Washer

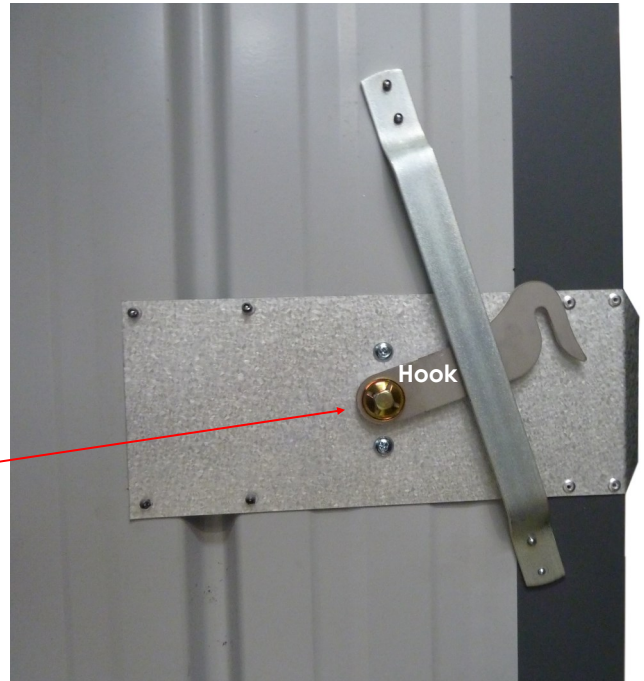

Step 2: Once door is hung, position the Locking Stays so they slide into the Locking Brackets easily. Screw Locking Stays to Door Jamb.



SECURITY DOOR (Optional)

Step 3: On the left hand Door Jamb, position latch as shown, at correct height to door handle. Rivet in place with four rivets.



RAISED FLOOR MODIFICATION

For sheds being placed on a purpose built floor, (concrete, cobbles, ply etc.), the Wall Sheets will protrude 20mm below the Base Plate. This will stop water flowing in between the Base Plate and Floor.

The Floor should be made 15mm smaller than Base Size.

Note: Although it is not essential, fitting Damp Proof Course in between the Base Plate and the Floor will give added protection against moisture.

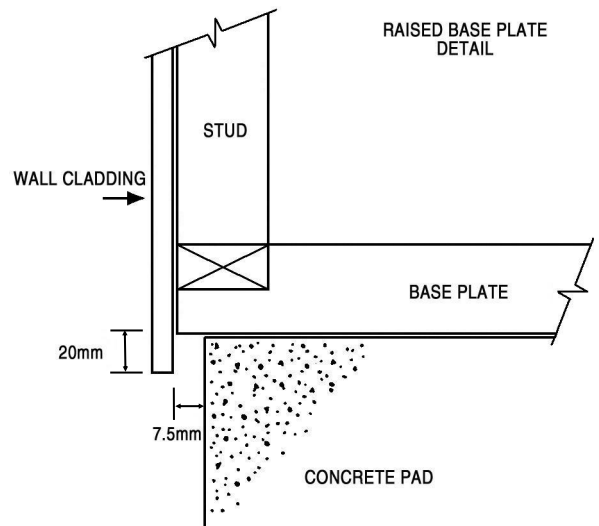

CLEAN UP

- Remove all swarf (drill filings) with a soft brush or rag.
- Hose down roof and walls thoroughly.
- For Coloursteel sheds use touch-up paint provided on all nail heads, rivets and exposed cuts.



COMPLETE OUR CUSTOMER SURVEY

Thank you for investing in a Duratuf Garden Shed.

We are sure that it will provide excellent long-term storage and add value to your property. To continually improve our products and service, we would love to hear about your Duratuf experience and why you chose us.

Further to that, we would also love to see a picture or a short video of your shed installed and doing its job so that we can share this with others for their inspiration. Thank you in advance and we look forward to receiving your feedback!

To complete the survey please visit

www.duratuf.co.nz/customer-survey



DURATUF PREMIUM SHED WARRANTY

GUARANTEE TO CUSTOMER

Congratulations on purchasing a Duratuf Storage Shed. With proper care and attention, this product will last many years.

For your benefit **PLEASE READ THE FOLLOWING INFORMATION CAREFULLY.**

WARRANTY ON METAL CLADDING

Riverlea Group Ltd guarantee that the metal roofing and wall cladding on Kiwi and Fortress Garden Sheds may be used in moderate and inland corrosion zones or areas where the first year mild steel corrosion rate is less than 200g/m², and that in these conditions, they will not perforate due to corrosion within 30 years of date of manufacture.

TERMS AND CONDITIONS

1. Damage or corrosion due to the following circumstances is not covered by this warranty.

- ◆ Mechanical, chemical or other damage sustained during or after installation.

NOTE: Clean swarf off shed **IMMEDIATELY** after assembly

Do **NOT** mark cladding with pencil

Do **NOT** allow manures, chemicals or other corrosive materials to have direct contact with cladding

Chemical damage will result if these instructions are not carried out

- ◆ Force majeure or other causes beyond the control of Riverlea Group Ltd.

2. This warranty does not cover material installed in severe and very severe environmental situations, or in any area where the mild steel corrosion rate (as published by BRANZ) exceeds 200g/m².

WARRANTY REGISTRATION

Please visit www.duratuf.co.nz/warranty to validate the Warranty on your shed.

Click on the Warranty Registration Link and complete all details.

If you are unable to access the computer, please phone us on 0800 438 274 and one of the customer services team will help you to activate the warranty on your garden shed.

Many thanks, from the Team at Riverlea Group.