

# Wairarapa

## Assembly Instructions

Base size: 3600 x 6000

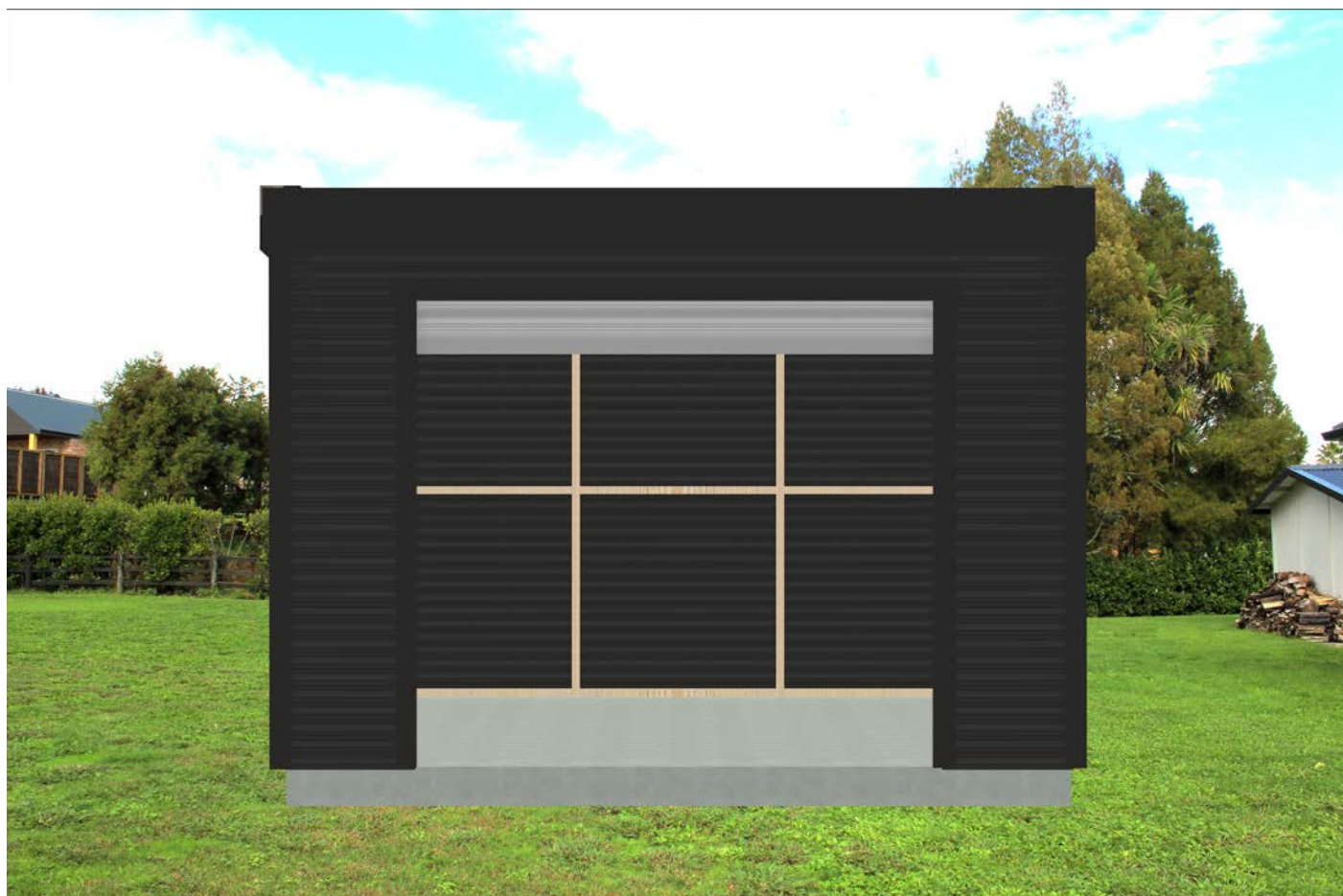

Kitset care guide:





# Contents

<b>Required tools</b>	2
<b>Before you start</b>	3
<b>Safety precautions</b>	3
<b>Select your site</b>	3
<b>Warranty requirements</b>	3
<b>Parts list</b>	4
<b>Hardware list</b>	6
<b>Base specifications</b>	7
<b>1. Timber frame assembly</b>	8
1.1 Back wall assembly	9
1.2 Side walls assembly	10
1.3 Front wall assembly	11
1.4 DPC attachment to bottom plate	12
1.5 Joining walls to each other	13
1.6 Ridge beam and door head flashing attachment	14
1.7 Timber frame to base securement	15
1.8 DPC attachment to studs	17
<b>2. Cladding attachment</b>	18
2.1 Side and back walls cladding attachment	19
2.2 Front wall cladding attachment	21
<b>3. Flashing attachment</b>	23
3.1 Top plate and door flashing attachment	23
3.2 Corner flashings attachment	24
3.3 Spouting assembly	25
3.4 Spouting attachment	26
<b>4. Roof sheets attachment</b>	27
4.1 Layout for fastening roof sheets	27
4.2 Optional clear roof sheet attachment	27
4.3 Roof sheets fastening	28
<b>5. Fascia and barges attachment</b>	31
5.1 Barge support attachment	31
5.2 Barge flashings and fascia attachment	32
<b>6. Roller door installation</b>	34
6.1 Brackets installation	35
6.2 Door placement on brackets	35
6.3 Door positioning	36
6.4 Springs tensioning	36
6.5 Bottom rail stop attachment	37
6.6 Guides installation	37
6.7 Handle fitment	38
6.8 Lift lock centring	38
6.9 Clean-up	38
6.10 Troubleshooting	39
6.11 Spring tension adjustment	40
<b>Duratuf Lifestyle shed warranty</b>	41

# Required tools



Riveter



Pipe wrench



Caulking gun



Tin snips (left & right hand)



Hacksaw



Adjustable spanner



Flat file



Hand saw



Hammer



Level



Utility knife



Cordless drill screwdriver



- Hex drive 5/16
- Hex drive 3/8



Phillips drill bit



Square drive drill bit



Slotted drill bit



Ladder



- Drill bit 3.5mm
- Drill bit 7mm



Hammer drill and 10mm and 12mm masonry bits



Tape measure



String line

## Before you start

- Read all instructions carefully.
- All dimensions are in millimetres.
- 2 people are required for shed install.
- Ensure all parts are included and you have access to all required tools.
- Engineering drawings and producer statements are available on the Duratuf website.
- Before assembly, remove protective film where present from all flashings and colored steel components.

## Safety precautions

- Do not attempt to build your shed in high winds.
- Wear work gloves, and ear and eye protection when assembling.
- Be cautious of sharp edges when handling parts.
- Use electric tools with care. Use a Safety Trip Switch.
- Ensure safety requirements are met when working with ladder. For more information visit:  
<https://www.worksafe.govt.nz/topic-and-industry/working-at-height/safe-working-with-ladders-and-stepladders-construction/>.

## Select your site

- Site must be level, with appropriate access around shed for installation.











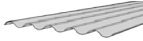
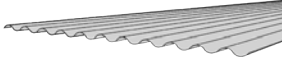
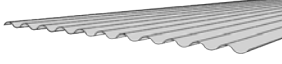
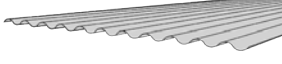
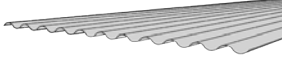
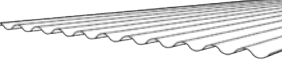







## Warranty requirements

The following maintenance process needs to be adhered to, to qualify for the steel warranty of your shed. For more information on the warranty, refer to the back page.













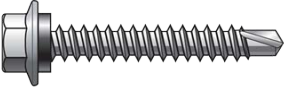
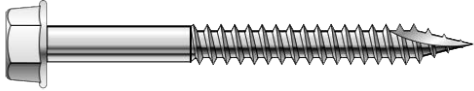

- Using water and soft nylon brush wash all surfaces annually.
- Within 2km of coast, wash every 3 months as above. After a storm, wash the cladding and the gutters as soon as possible, to remove any highly corrosive salt deposits.
- Volcanic ash fallout: wash as soon as possible, removing fallout from roof and gutters.
- Do not allow manures, chemicals or other corrosive materials to have direct contact with cladding.
- Force majeure or other causes are beyond the control of Riverlea Group.
- All metal filings (swarf) must be removed immediately after assembly.
- Avoid contacting steel with sunscreen or pencil, as this could damage the steel cladding.

# Parts list

Part ID	Part name	Timber size (mm)	Quantity	Length (mm)	Diagram
TB003	Bottom plate-3 (Side)	90x45	2	5820	
TT003	Top plate-3 (Side)	90x45	2	5820	
TB010	Bottom plate-10 (Front+Back)	90x45	2	3600	
TT010	Top plate-10 (Front+Back)	90x45	2	3600	
TN002	Nog-2 (Side)	90x45	4	1040	
TN004	Nog-4 (Back+Side)	90x45	6	1154	
TN010	Nog-10 (Back)	90x45	3	1140	
TN011	Nog-11	90x45	2	465	
TS001	Stud-1 (Front)	90x45	3	310	
TS002	Stud-2 (Front)	90x45	2	2123	
TS003	Stud-3 (Back+Side)	90x45	16	2250	
TS004	Stud-4 (Front)	90x45	4	2476	
TL001	Lintel-1	90x45	1	2490	
TR027	Ridge beam (181mm Tongue)	200x45	1	3600	
TR028	Ridge beam (136mm Tongue)	200x45	1	3600	
TR029	Ridge beam (91mm Tongue)	200x45	1	3600	
TR030	Ridge beam (46mm Tongue)	200x45	1	3600	

Part ID	Part name	Qty	Length (mm)	Diagram	Checked	Packed
	Front wall half sheet	1	3600			
	Front wall sheet	6	600			
	Side wall sheet	6	6000			
	Back wall sheet	3	3600			
	Roof sheet	5	6590			
	Optional clear roof sheet		6590			
FDH001	Door head flashing-1	1	2400			
FBS005	Spouting-5	1	3725			
FS001	Spouting end cap	2				
FBC001	Back corner flashing-1	2	2365			
FB003	Barge flashing-2	2	6660			
FB004	Barge support-2	2	5870			
FF006	Fascia-6	1	3725			
FDP001	Downpipe cover flashing	1	2170			
FDJ001	Door jamb flashing-1	2	2192			
FFC001	Front corner flashing-1	2	2588			
FFT005	Front top plate flashing-5	1	3600			
FDF001	Door top flashing	1	2595			
	PVC downpipe	1	3000			
	Steel roller door	1	2400			
	Damp proof course (DPC)	1				
	Dropper and sleeve	1				
	Downpipe bracket	2				

# Hardware list

Part name	Quantity	Diagram
30mm clout nails (cladding)	210 pcs	
90mm nails (framing)	190 pcs	
Rivets	75 pcs	
25mm Hex head Tek Screw (coloured/zinc)	360 pcs	
35mm Hex head Tek Screw (zinc)	16 pcs	
55mm Hex head Tek Screw (coloured/zinc)	210 pcs	
100mm Hex head Tek Screw (zinc)	16 pcs	
"L" bracket	4 pcs	
M10 x 140 screw bolts (blue head)	4 pcs	
M12 X 135 through bolt	16 pcs	
Purlin concealed cleats 86x40mm	24 pcs	
Brace strapping	1 roll	
Dome washer (for clear roof sheet)	20 per clear sheet	
Silicone tube	1	
Retouch paint bottle	1	
Retouch brush	1	



# Base specifications

Use the below specifications to build a concrete base for shed:

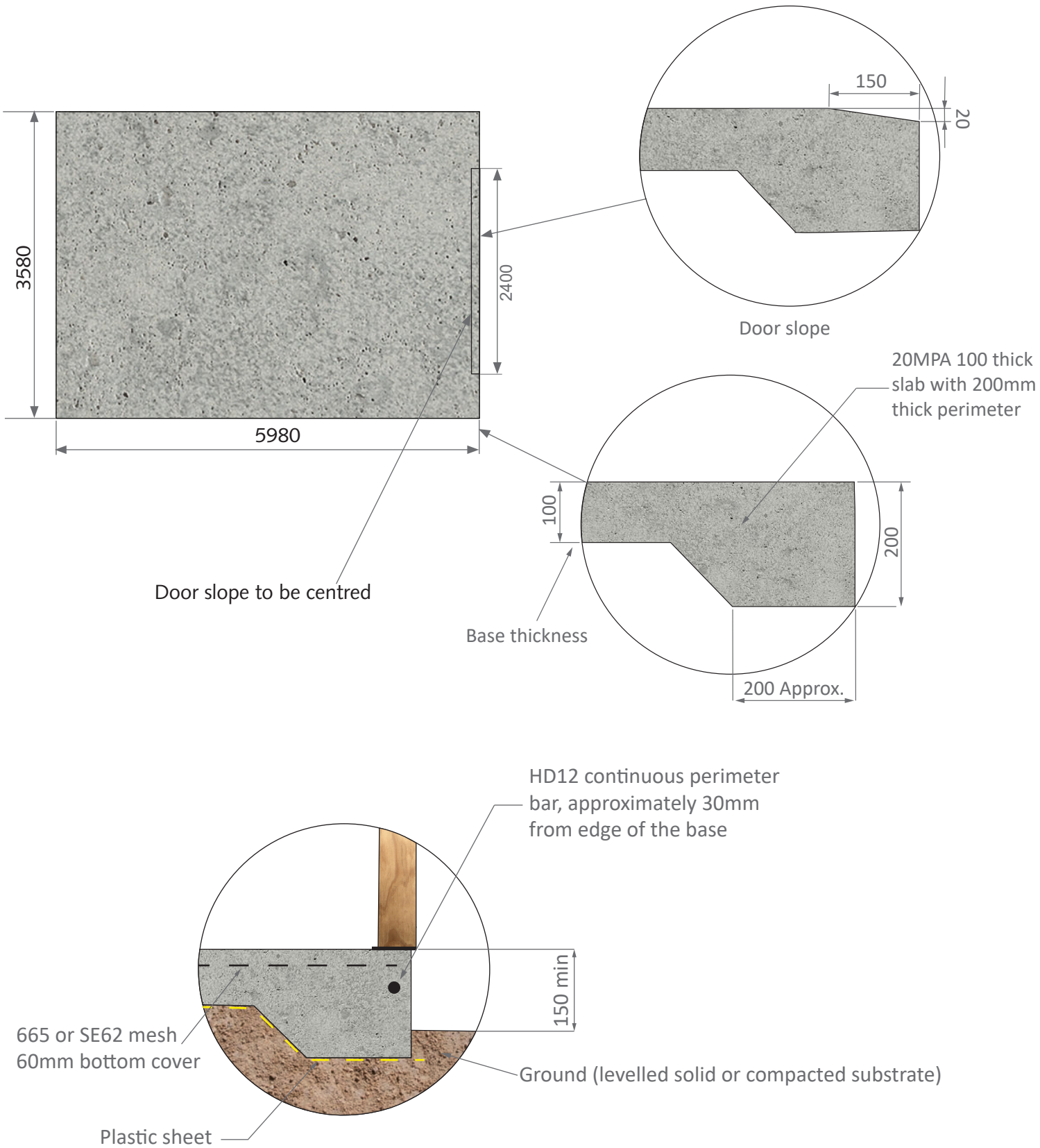

- Concrete to NZS 3101

# 1. Timber frame assembly



- Arrange the parts specified in the following steps on a flat surface and attach them together using two 90mm nails at each join.
- Studs should be positioned between top and bottom plates.

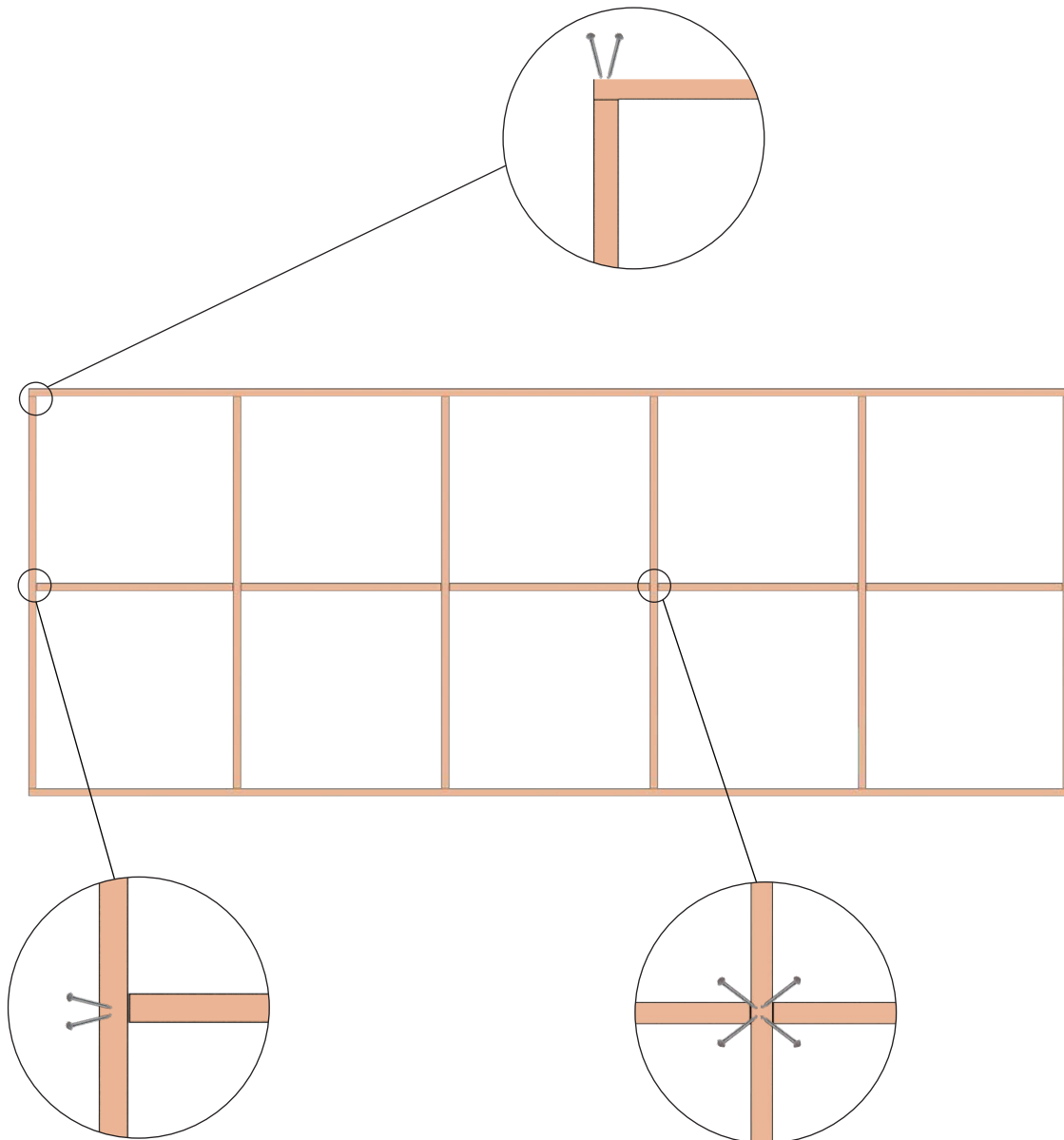

## 1.1 Back wall assembly

- 1** Nail top and bottom plates to end studs.

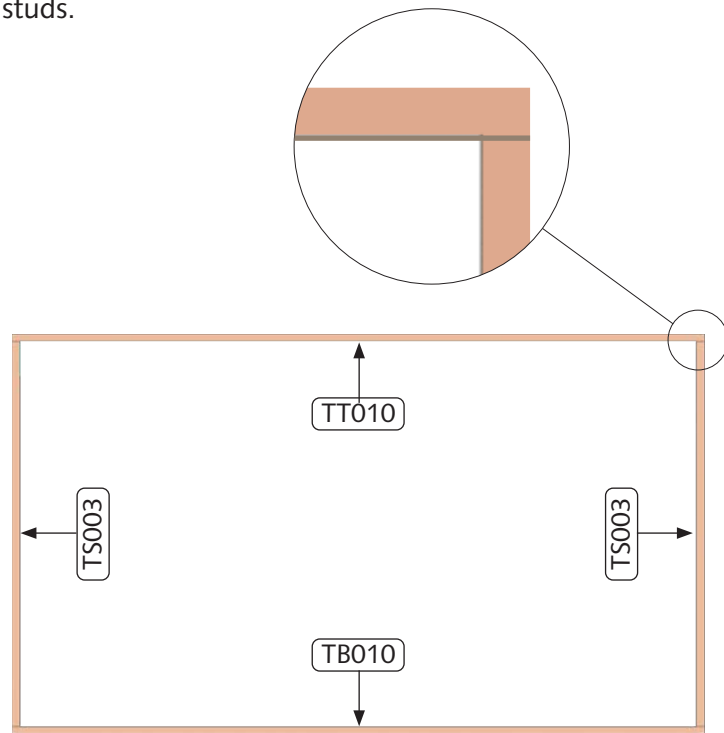

- 2** Nail remaining studs in correct position.

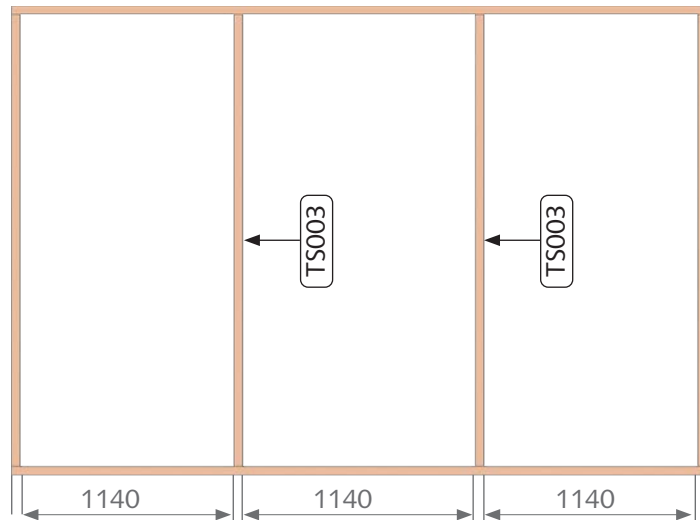

- 3** Nail in nogs at correct height.

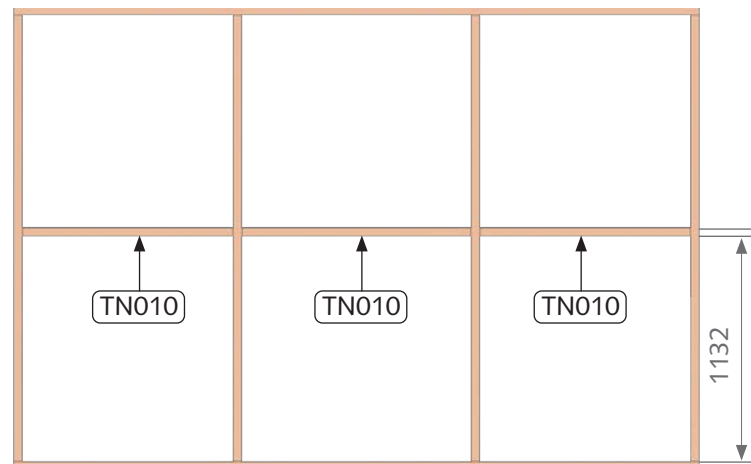

•Regarding Part IDs refer to the Parts list in pages 4 & 5.

## 1.2 Side walls assembly

- 1 Nail top and bottom plates to end studs.

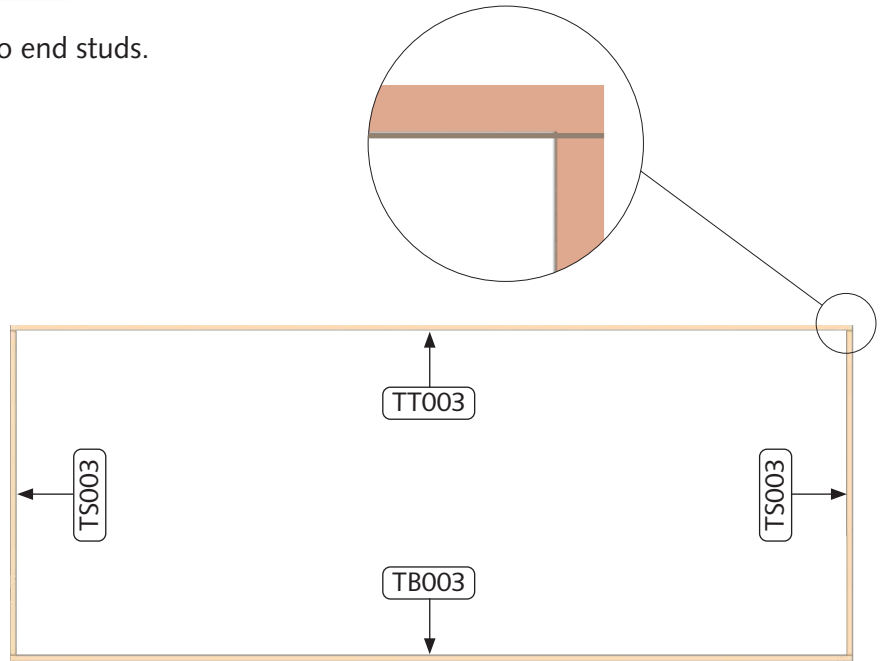

- 2 Nail remaining studs in correct position.

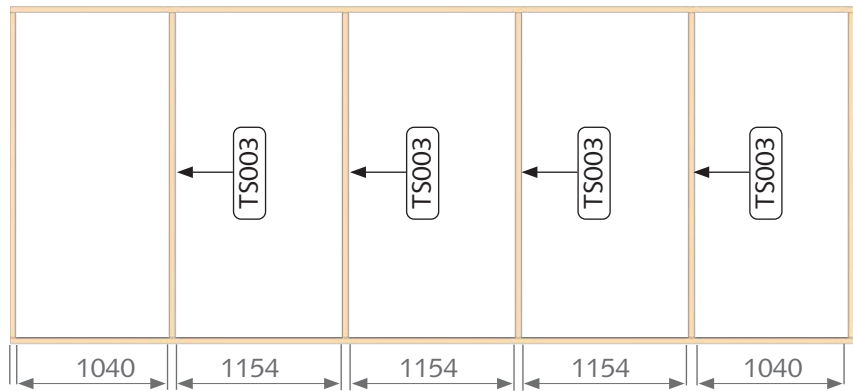

- 3 Nail in noggs at correct height.

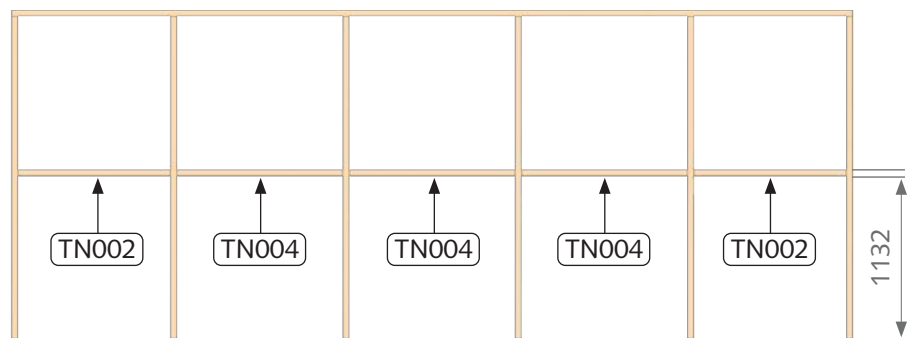

•Regarding Part IDs refer to the Parts list in pages 4 & 5.

## 1.3 Front wall assembly

**1** Nail top and bottom plates to end studs.

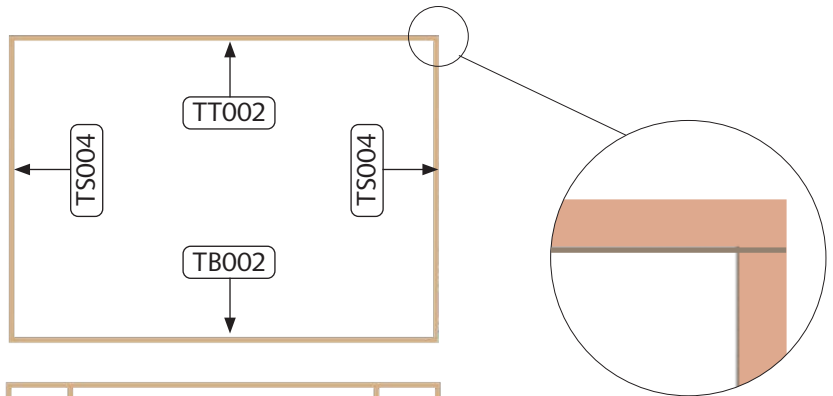

**2** Nail remaining studs in correct position.

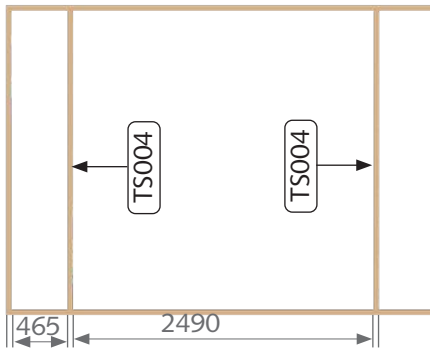

**3** Nail in nogs at correct height.

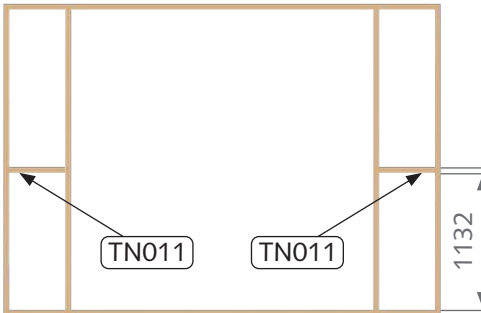

**4** Nail shorter studs each side of doorway, using 4 nails evenly spaced into longer stud and 2 nails through bottom plate. Nail lintel to studs at each end.

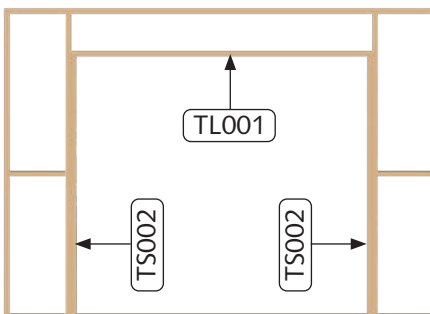

**5** Nail studs above doorway to top plate and lintel.

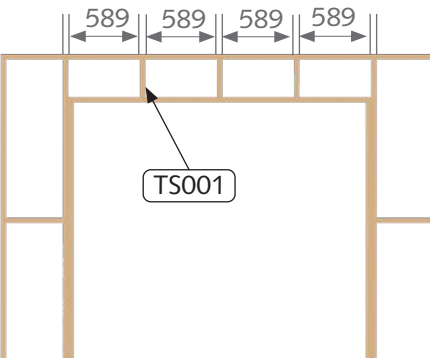

•Regarding Part IDs refer to the Parts list in pages 4 & 5.

## 1.4 DPC attachment to bottom plate

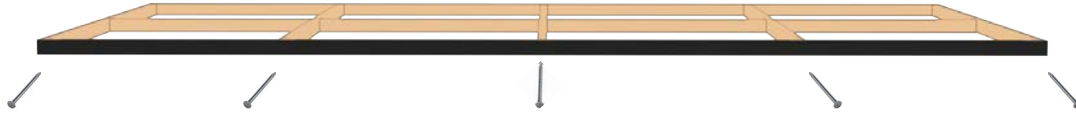

Cut pieces of the DPC roll to the length of each wall panel and nail them to underside of bottom plate on wall panels (using 30mm clouts underneath each stud, flush with the outside edge of the bottom plate).



## 1.5 Joining walls to each other

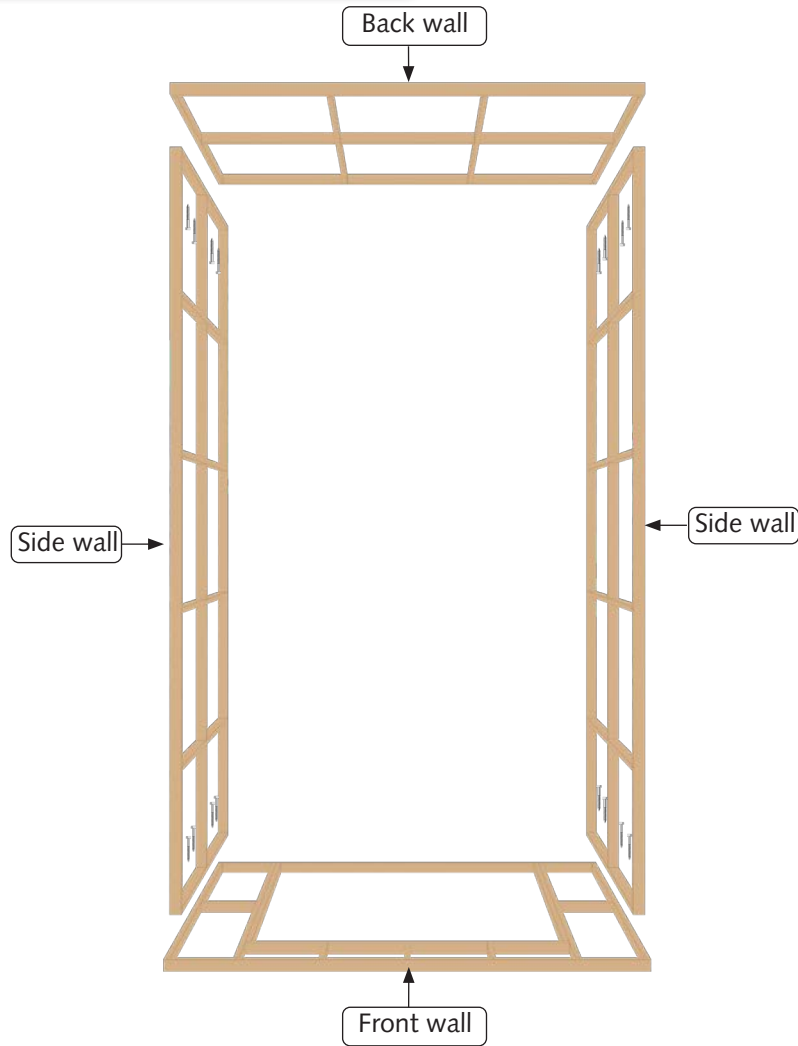

**1**

Pre-drill side wall frames as shown using 7mm drill bit.



100mm Hex head Tek Screw

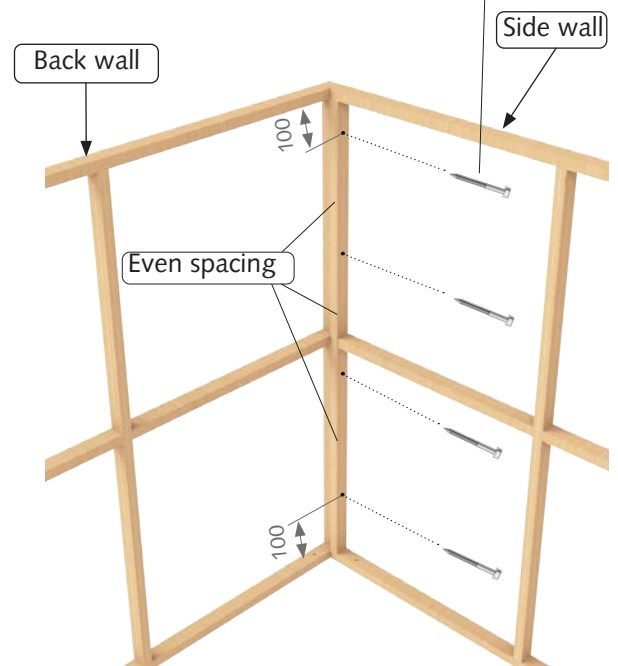

**2**

Screw frames together using a cordless drill screwdriver and four 100mm Hex head Tek Screws at each corner.

## 1.6 Ridge beam and door head flashing attachment

- 1 Fix each ridge beam's 2 ends to the side walls above each stud, using 3 cleats (2 at the top and 1 underneath) and four 25mm Hex head Tek Screws, per cleat.

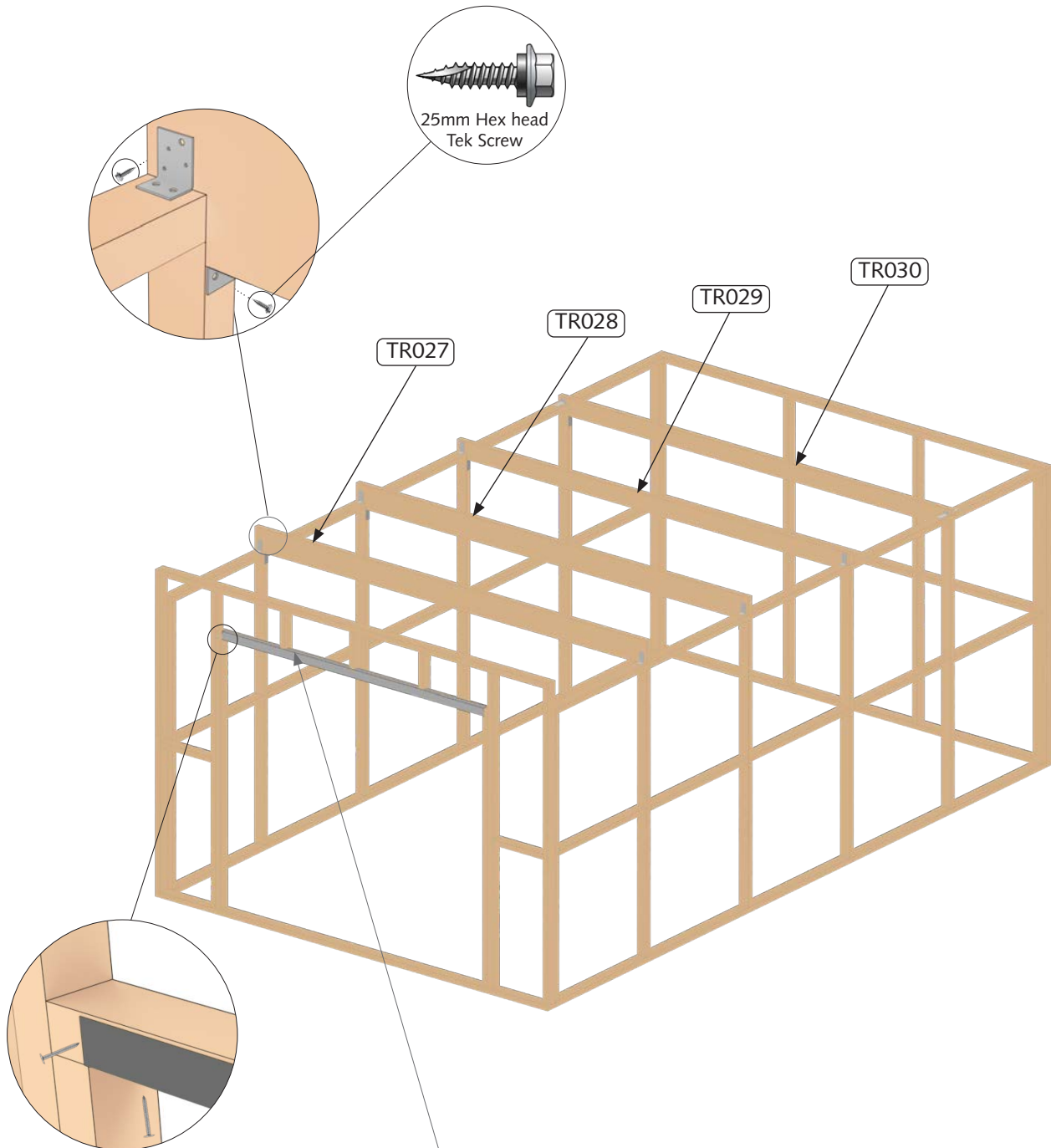

- 2 Attach door head flashing (FDH001) to the lintel using six 30mm clouts (3 outside, 3 underside).

•Regarding Part IDs refer to the Parts list in pages 4 & 5.



## 1.7 Timber frame to base securement

- 1 Adjust the frame to get a 10mm overhang on all 4 sides. Then, make sure diagonal measurements as shown are the same, to ensure frame is straight and square.

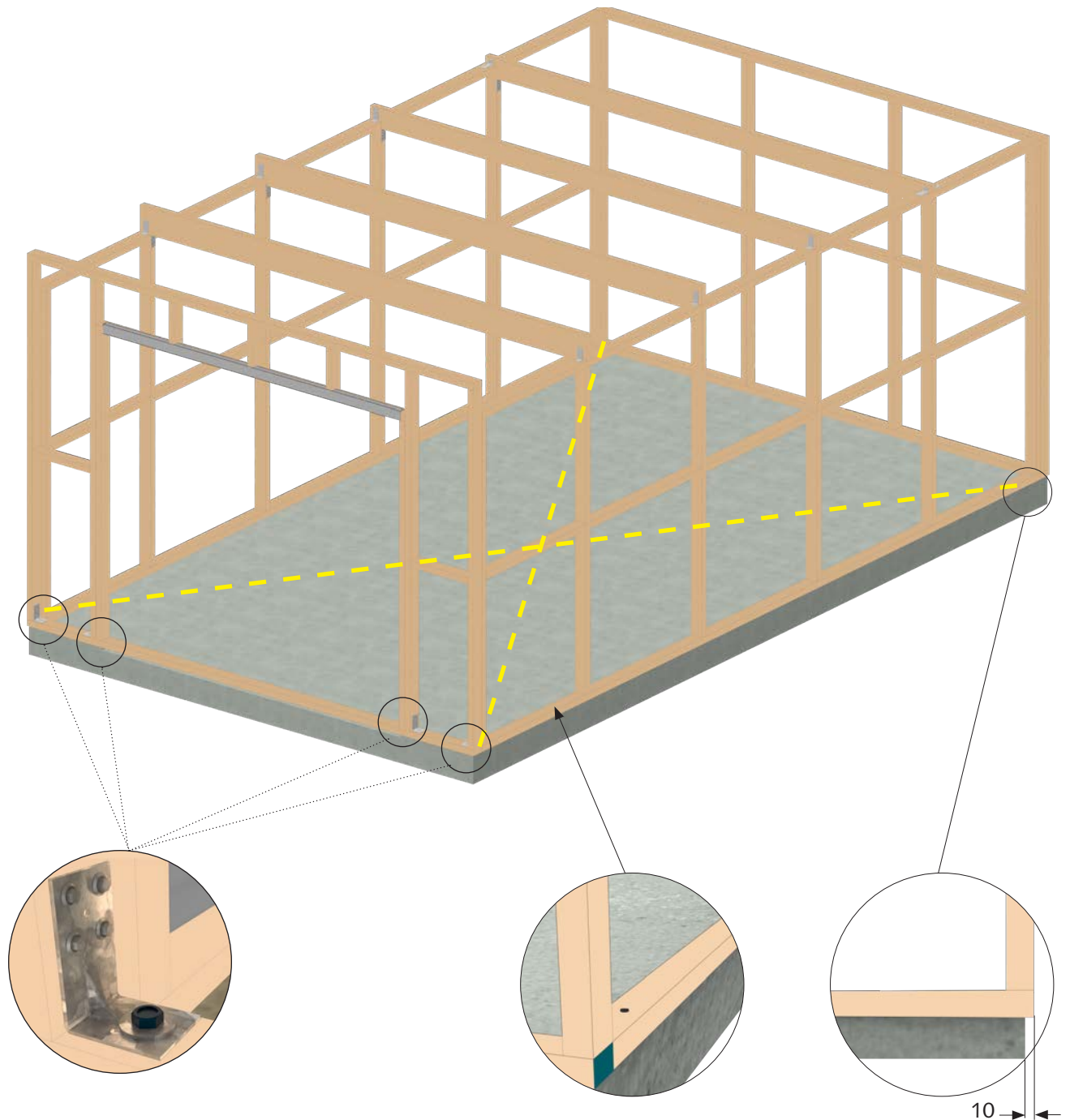

- 2 Pre-drill a hole within 50mm from one side of studs as shown, through timber and concrete base using hammer drill and 12mm masonry drill bit (16 holes in total). Fasten timber frame to the base through the holes using M12x135 through bolts.
- 3 Only on the front wall, pre-drill 4 holes approximately 35mm from the outermost and innermost studs through bottom plate and concrete base using hammer drill and 10mm masonry drill bit. Secure 4 "L" brackets to studs using four 35mm Hex head Tek Screws and to the bottom plate using M10 x 140 screw bolts.

- 4** Ensure diagonal measurements on front wall are the same. Then attach brace strapping in a cross on both left and right sides of the front door, using 30mm nails.

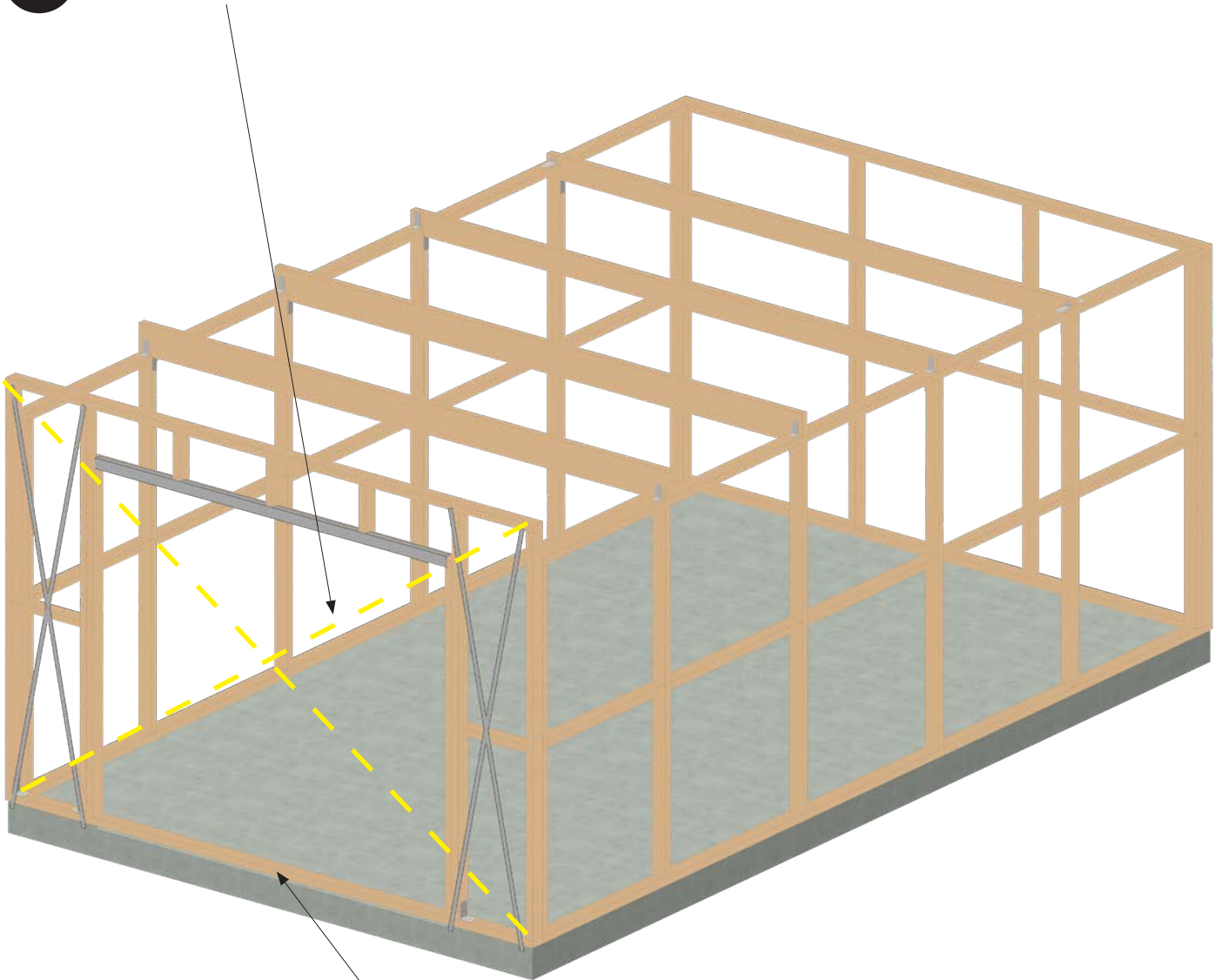

- 5** Cut bottom plate between door studs using a hand saw (flush with inside of front wall studs).

## 1.8 DPC attachment to studs

- Using ten 30mm clouts, attach DPC to each corner as shown. DPC should be level with top of top plate and 20mm below bottom of bottom plate.
- Repeat above, attaching DPC to door studs with top of DPC level with underside of lintel.

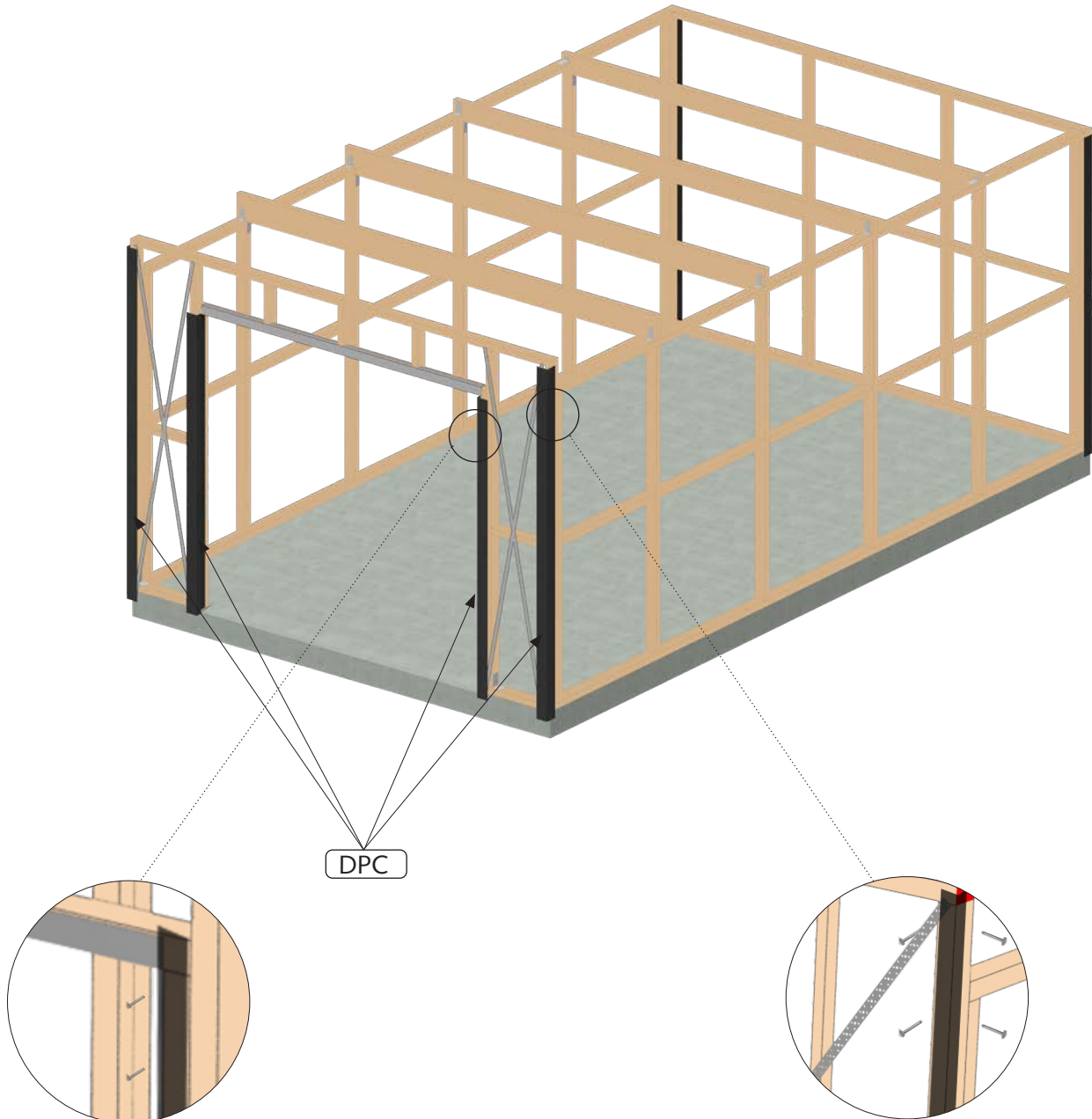

- If fitting optional building paper to walls, ensure diagonal measurements on each wall frame are the same.
- Use packaging timber (or similar) as bracing and nail to inside of frame to temporarily hold wall panel square.
- Staple building paper to outside of frame and proceed with wall claddings. Once the cladding is complete, remove timber bracing.

## 2. Cladding attachment

**External edges:** use Hex head Tek Screws through every 2<sup>nd</sup> trough.

**Internal edges:** use 2 Hex head Tek Screws per sheet, per stud.

**Top & bottom plate:** use Hex head Tek screws at every stud.

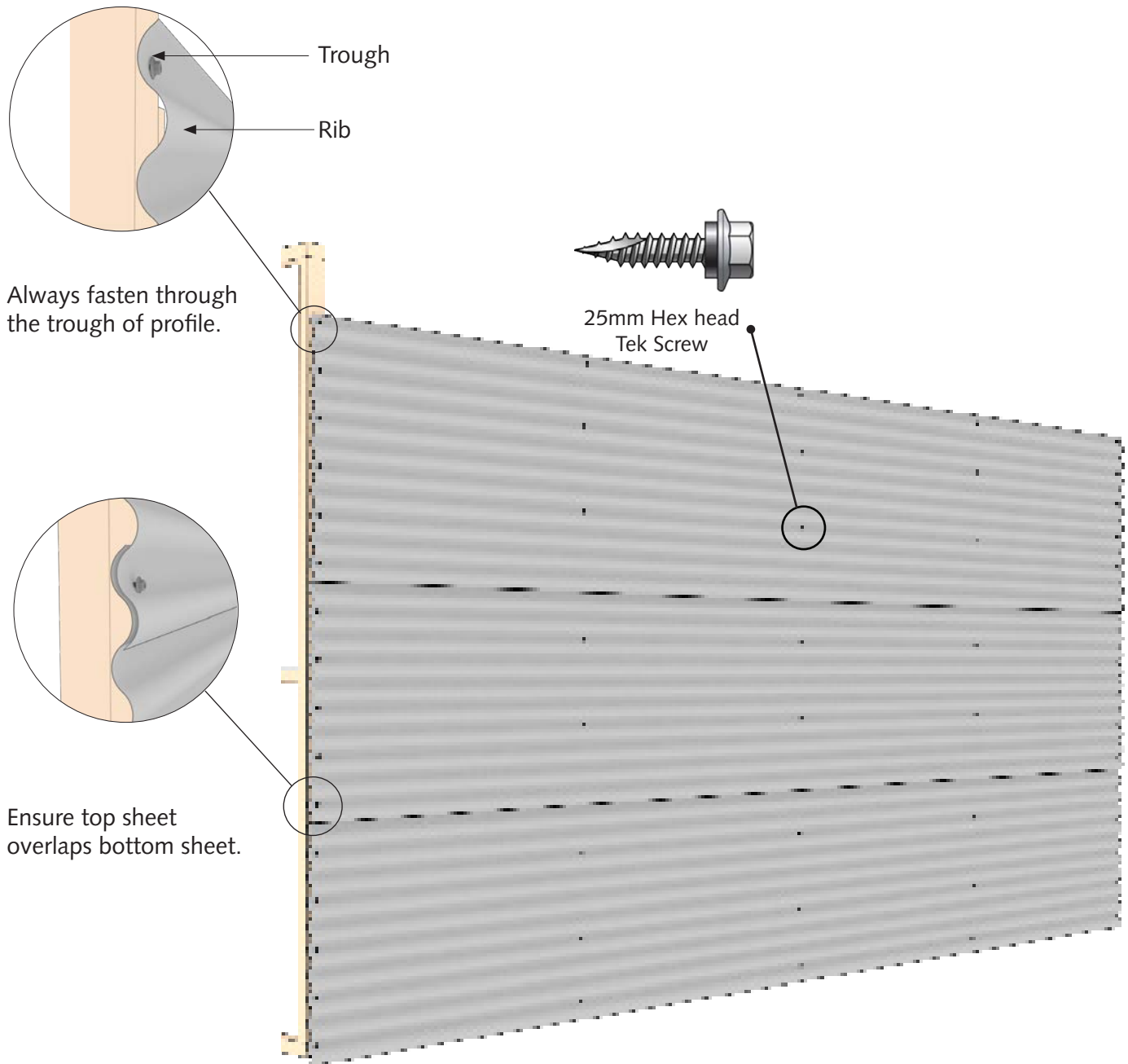

- Top sheet must be flush with the top of the top plate.
- Ends of the corrugated sheets must be flush with outside of studs.
- Ensure metal filings have been removed from between sheets, and between sheets and fasteners.
- Pre-drill cladding using 3.5mm drill bit for easy fastening.

## 2.1 Side and back walls cladding attachment

**1**

- Position first sheet and secure it to timber frame using two 25mm Hex head Tek Screws at the top corners (about 30mm back from end of sheet). Top of the sheet to be flush with top of top plate and both ends flush with outside of studs, ensuring bottom of sheet is approximately 850mm down from side top plate (TT001).
- Fasten two 25mm Hex head Tek Screws 2 ribs up from the bottom of sheet ensuring end of sheet is flush with outside of studs.

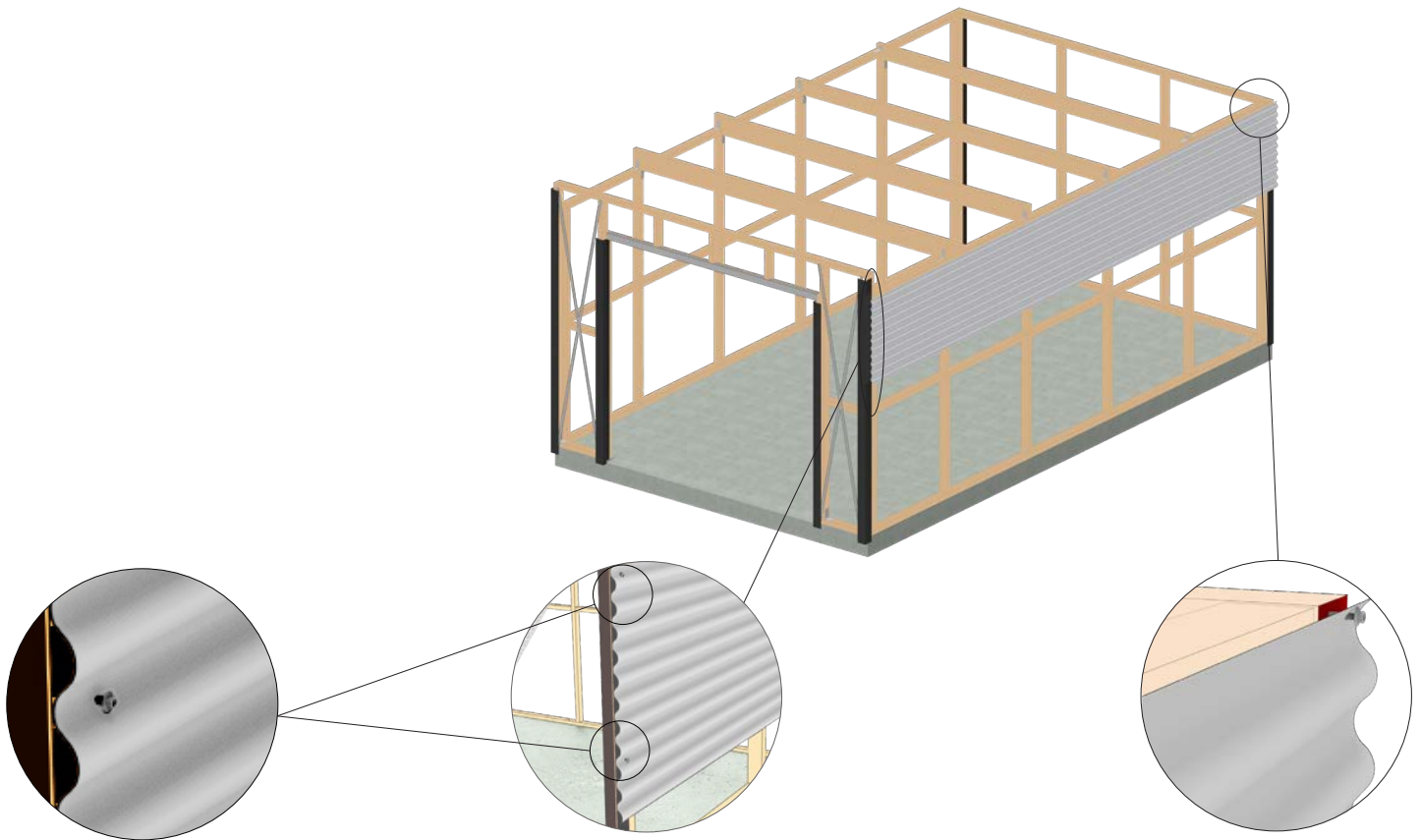

**2**

- Position the second sheet underneath the first sheet, ensuring top sheet overlaps the outside of the bottom sheet, and bottom of sheet is approximately 1612mm down from side top plate (TT001).
- Attach the sheet to timber frame using two 25mm Hex head Tek Screws at the top corners in the overlap.
- Fasten two 25mm Hex head Tek Screws 2 ribs up from the bottom of sheet ensuring end of sheet is flush with outside of studs.

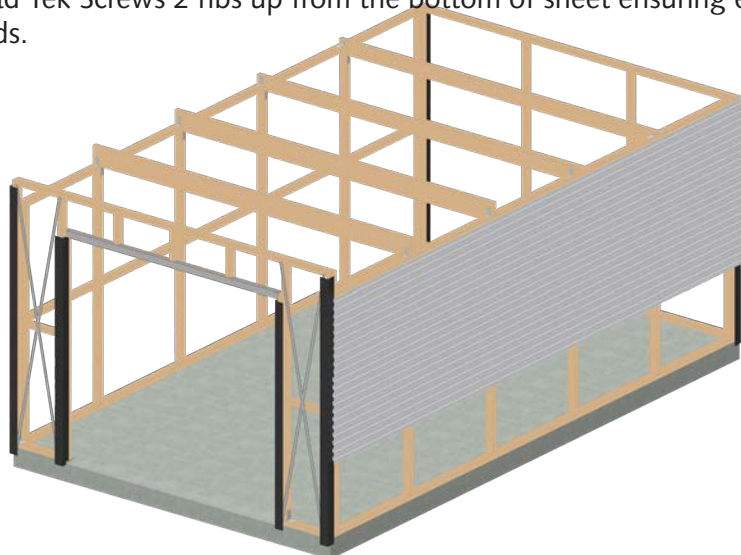

**3** Position and attach third sheet.

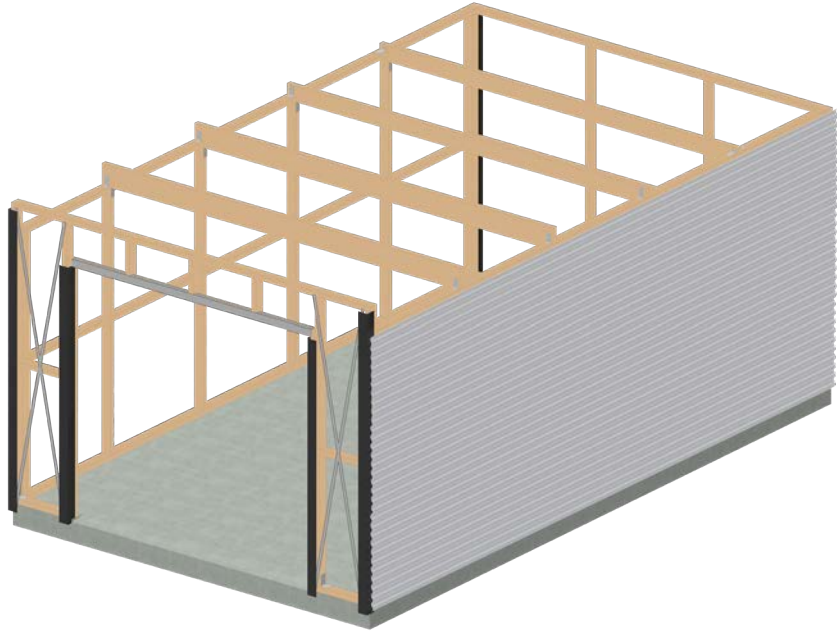

**4** Repeat these steps for remaining back and side walls sheets.

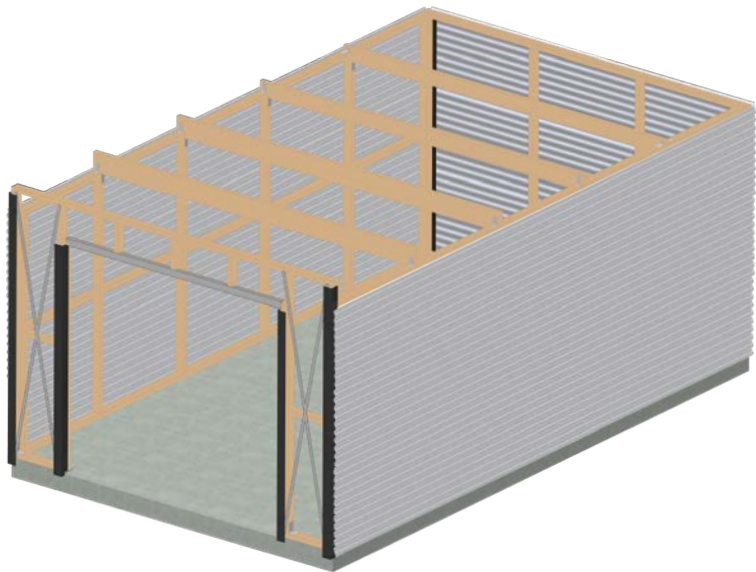

**5** Screw the 3 sheets of back and side walls using 25mm Hex head Tek Screws in the middle of each sheet (5 screws per end of each sheet and 2 in the middle).

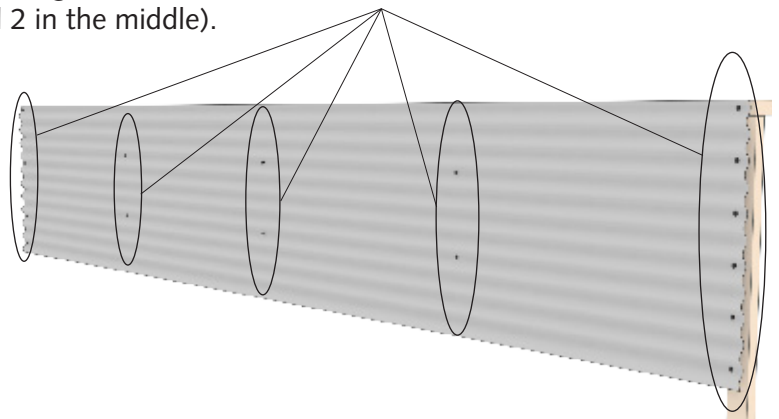

## 2.2 Front wall cladding attachment

- Position and attach sheets (as shown in the following steps) to the front wall frame, using three 25mm Hex head Tek Screws at each end.
- For front wall half sheet, also use 3 screws along the top plate (1 Hex head Tek Screw in each 310mm stud). Top of this sheet to be flush with top of the top plate.
- For all sheets both ends should be flush with outside of studs.

- 1** Ensure bottom of front wall half sheet is approximately 390mm down from top of front top plate (TT002), and front wall cladding profile height matches side wall profile height.

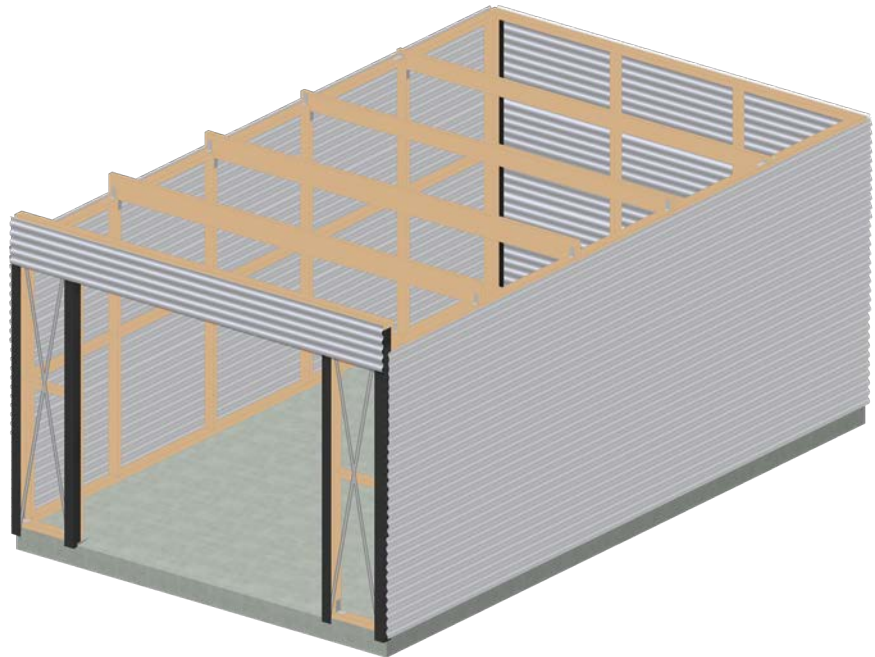

- 2** Ensure bottom of first row of front wall sheets is approximately 1147mm down from top of front top plate (TT002), and front wall cladding profile height matches side wall profile height.

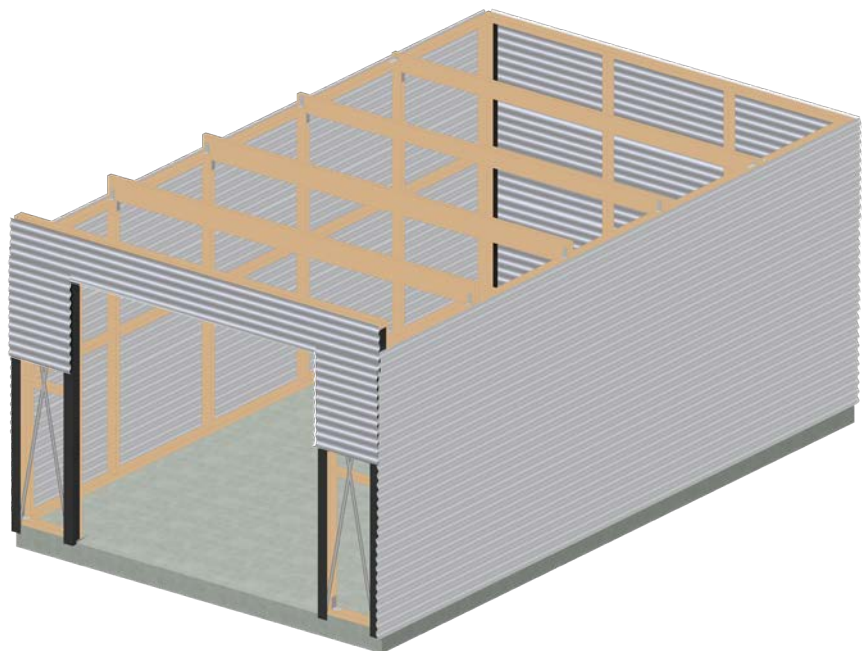

•Regarding Part IDs refer to the Parts list in pages 4 & 5.

- 3** Ensure bottom of second row of front wall sheets is approximately 1832mm down from top of front top plate (TT002), and front wall cladding profile height matches side wall profile height.

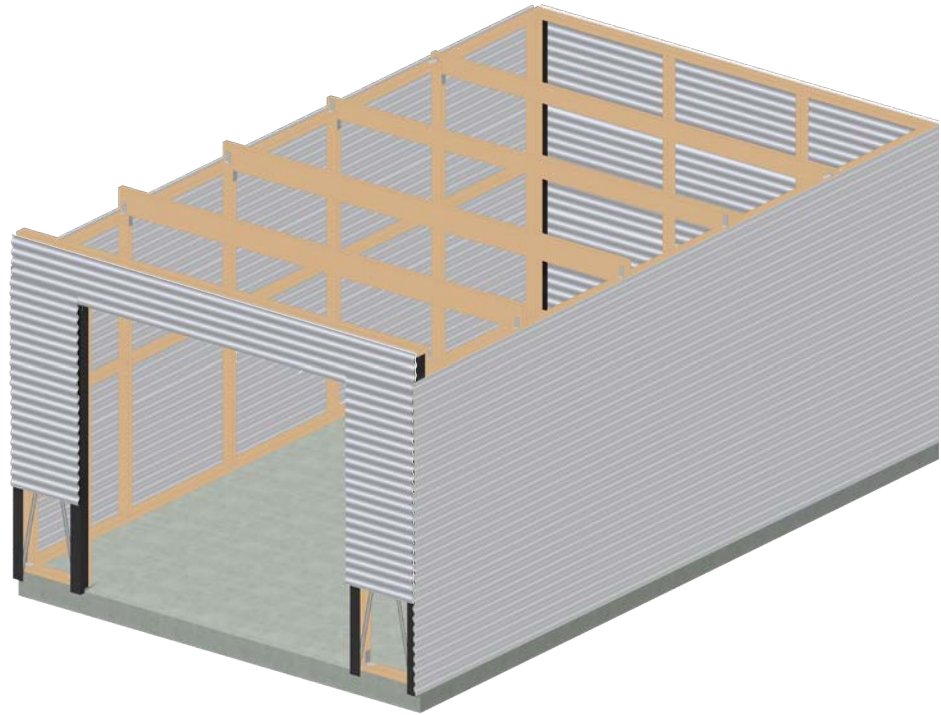

- 4** Attach third row of front wall sheets and screw off sheets as per cladding plan.

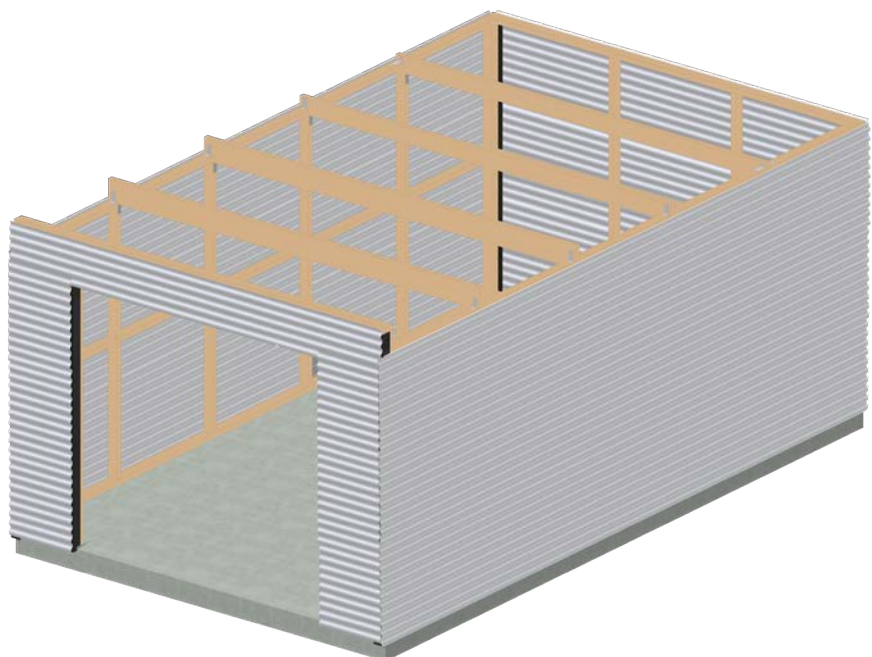



## 3. Flashing attachment

### 3.1 Top plate and door flashing attachment

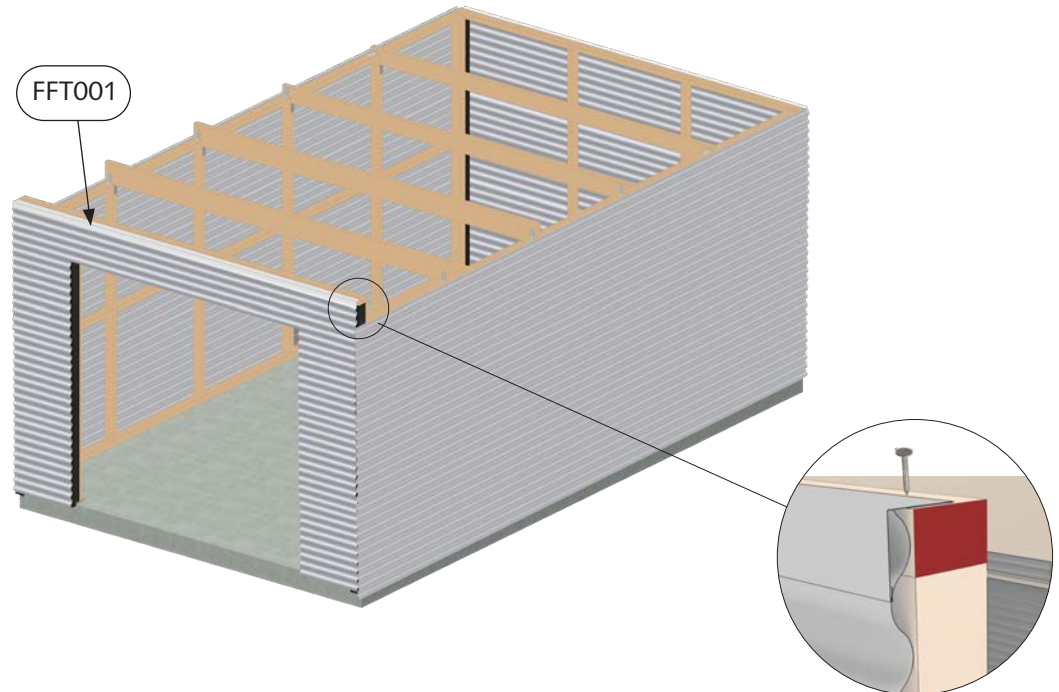

- 1** Centralise front top plate flashing (FFT001) and attach with four 30mm clouts to top plate.
- 2**
  - Position door jamb flashing (FDJ001), so top is level with underside of lintel (TL001).
  - If required, notch bottom of flashing around concrete using tin snips.
  - Nail door jamb flashing to inside of stud using three 30mm clouts and screw it into stud through the front of wall cladding using three 55mm Hex head Tek Screws.
- 3** Screw door top flashing (FDF001) to lintel (TL001) using three 55mm Hex head Tek Screws (1 at each end and 1 in the middle). Door top flashing length will protrude about 10mm past outside edge of each door jamb flashing.

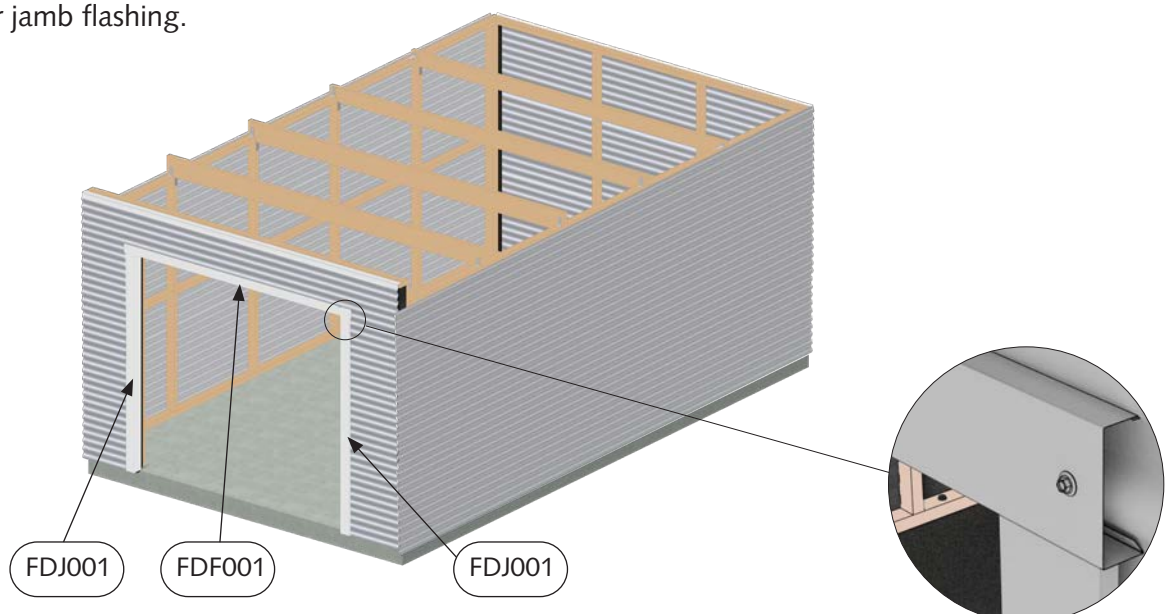

•Regarding Part IDs refer to the Parts list in pages 4 & 5.

## 3.2 Corner flashings attachment

- Attach corner flashings onto corners using six 55mm Hex head Tek Screws per corner, approximately 250mm down from top of the top plate.
- Ensure corner flashings are square and parallel with wall panels.
- Ensure bottom of flashings are level with bottom of cladding.

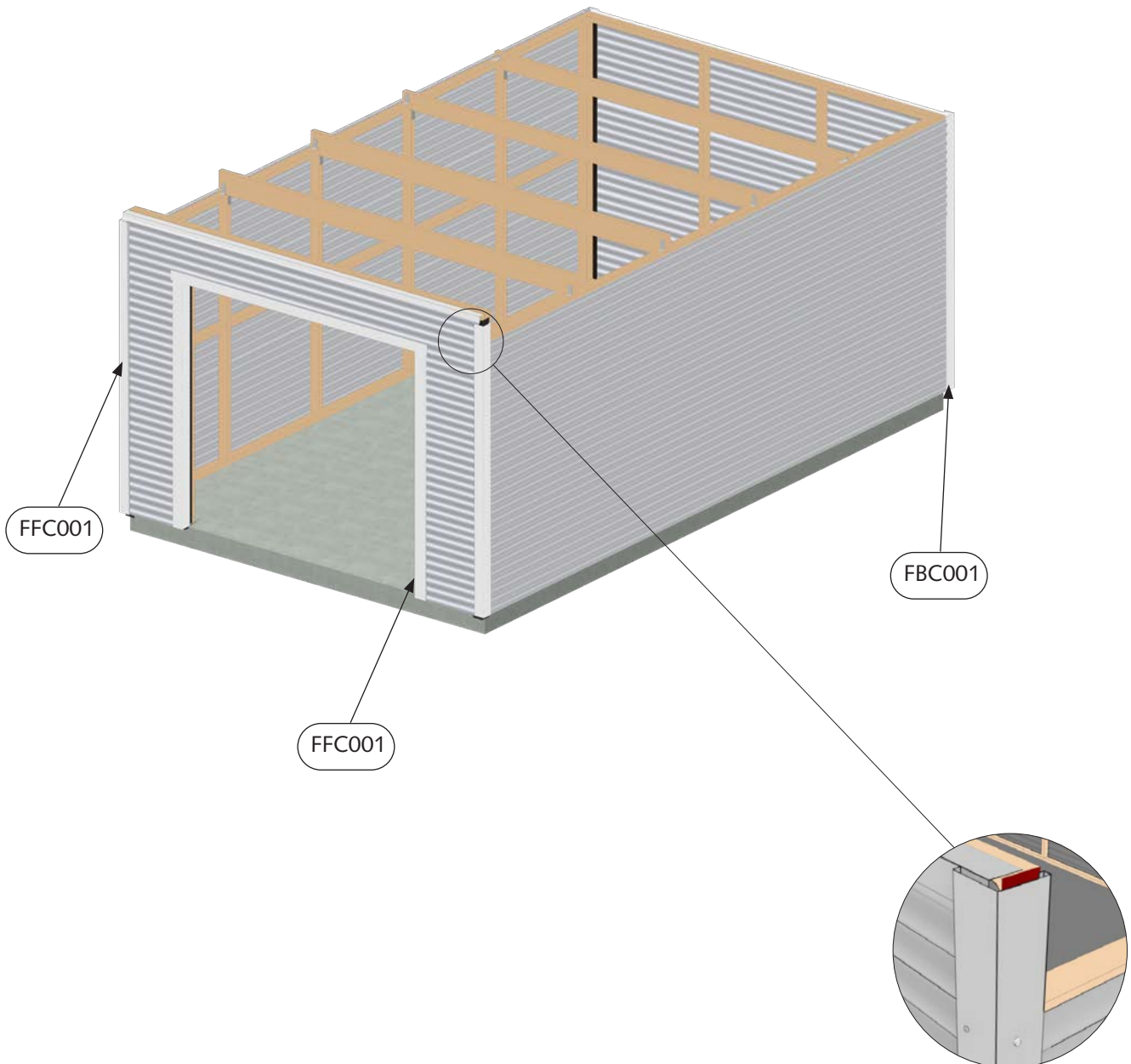

## 3.3 Spouting assembly

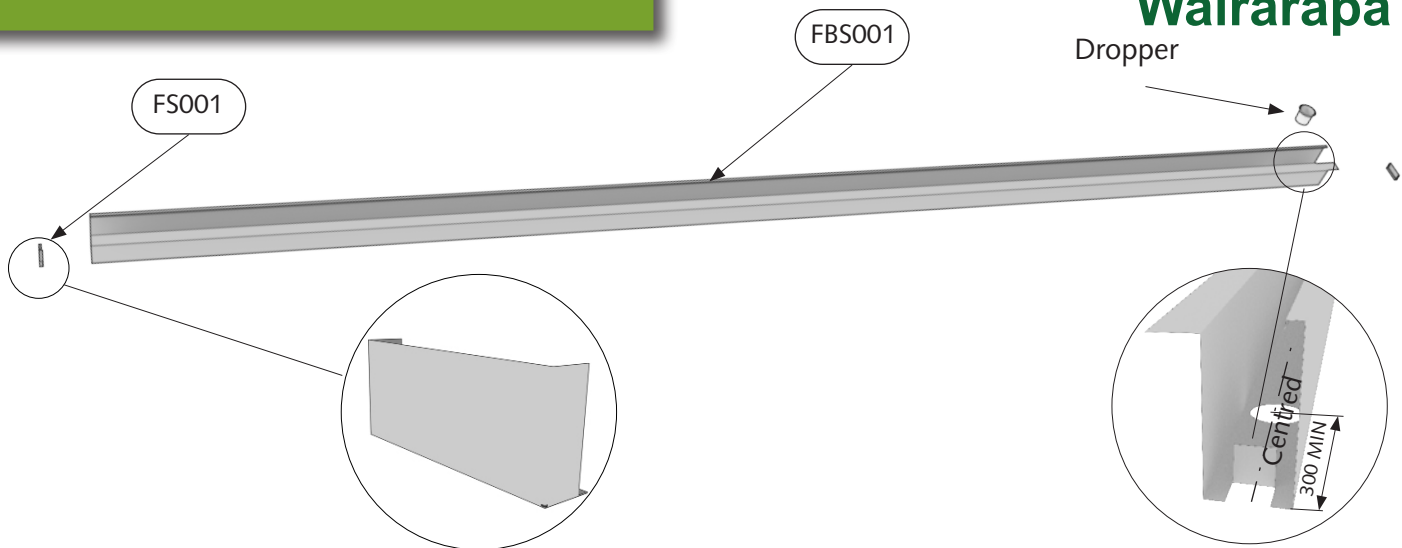

**1**

- Position dropper anywhere on the spouting (at least 300mm from either end, centred front and back) and mark diameter of dropper.
- Drill a small hole, and using tin snips, cut a larger hole (slightly larger than the diameter of dropper).

**2**

- Silicone around the hole and insert dropper into hole.
- Screw sleeve onto dropper from underneath.

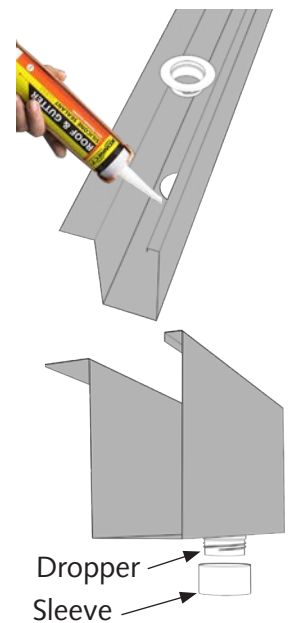

**3**

- Using tin snips cut two 50mm snips in each end of spouting as shown.
- Bend tab between snips upwards until it is 90° to base of spouting.

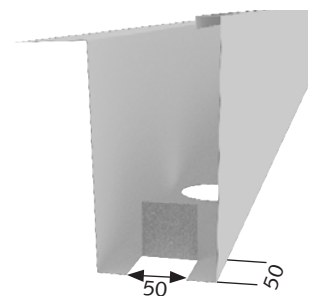

**4**

- Fit and rivet end caps behind tab to each end using 4 rivets per end.
- Silicone both end caps to spouting to ensure there is no leak.

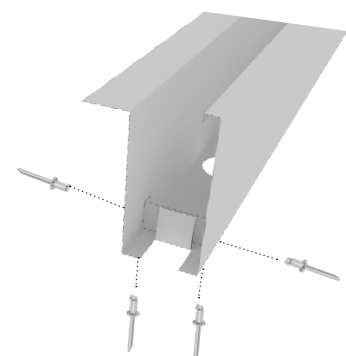

- 1** Centralise and nail the assembled spouting to top of the back top plate using four 30mm clouts, so spouting overhangs corner flashings by approximately 25mm at each end.

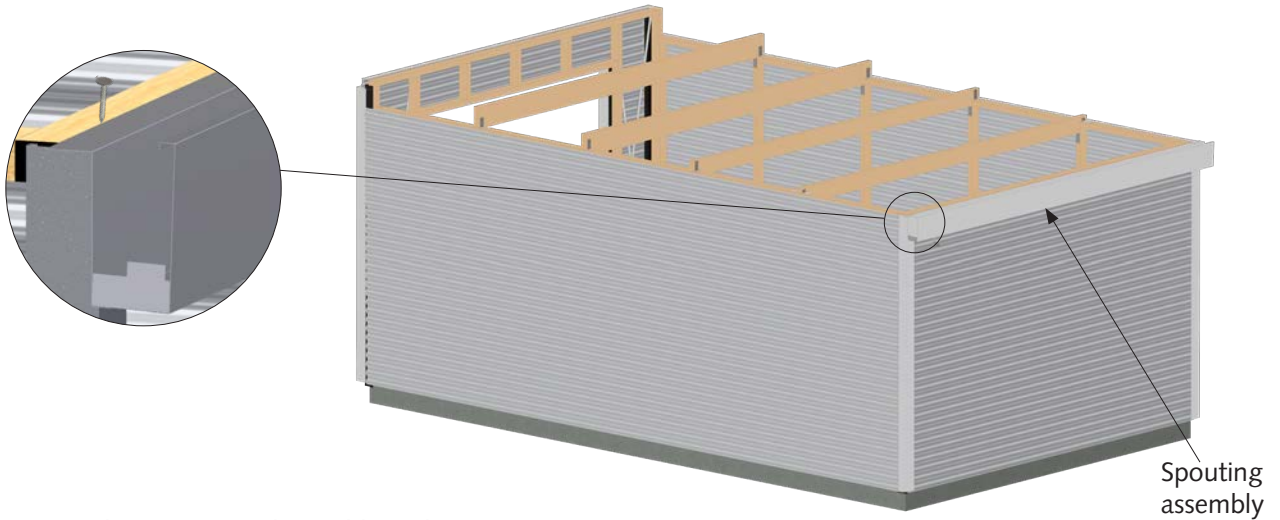

- 2**
- Cut downpipe to desired length.
  - Insert downpipe into dropper, and fasten it using 1 rivet.
  - Fix downpipe to the back wall cladding using 2 downpipe brackets, equally-spaced, riveting them into back wall cladding.

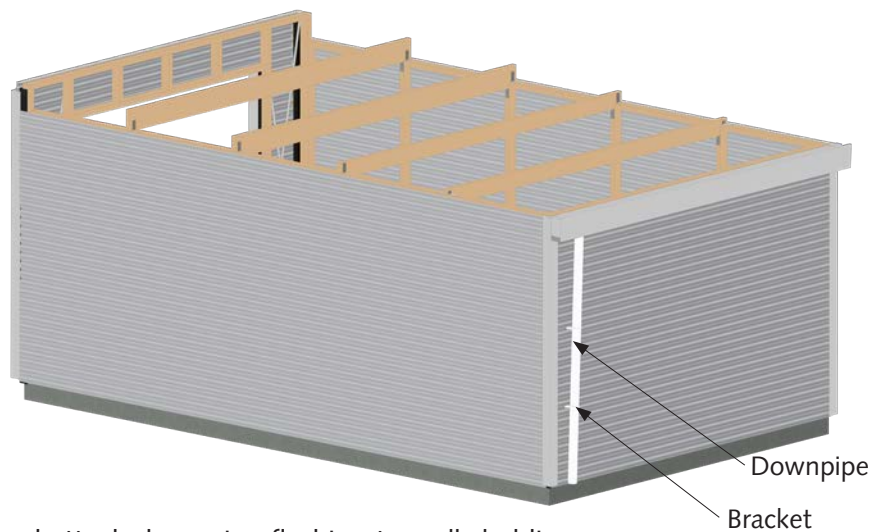

- 3** Using 6 rivets equally-spaced attach downpipe flashing to wall cladding.

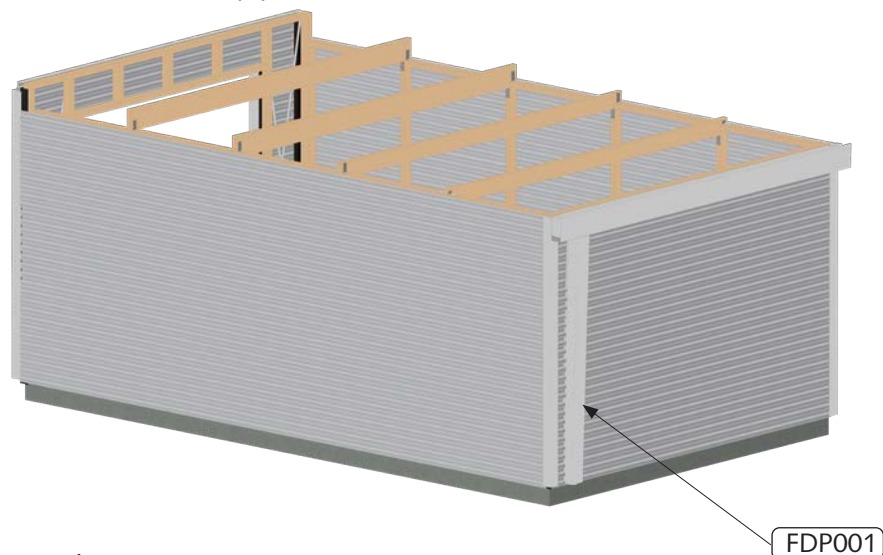

## 4. Roof sheets attachment

### 4.1 Layout for fastening roof sheets

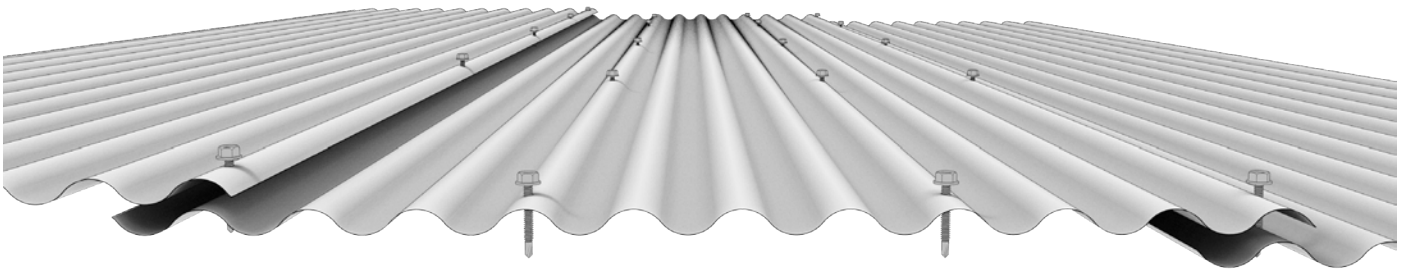

- Use 55mm Hex head Tek Screws to fasten roof sheets.
- Always fasten through top of rib of profile.
- Use 4 Hex head Tek Screws per sheet / top plate / ridge beam.

### 4.2 Optional clear roof sheet attachment

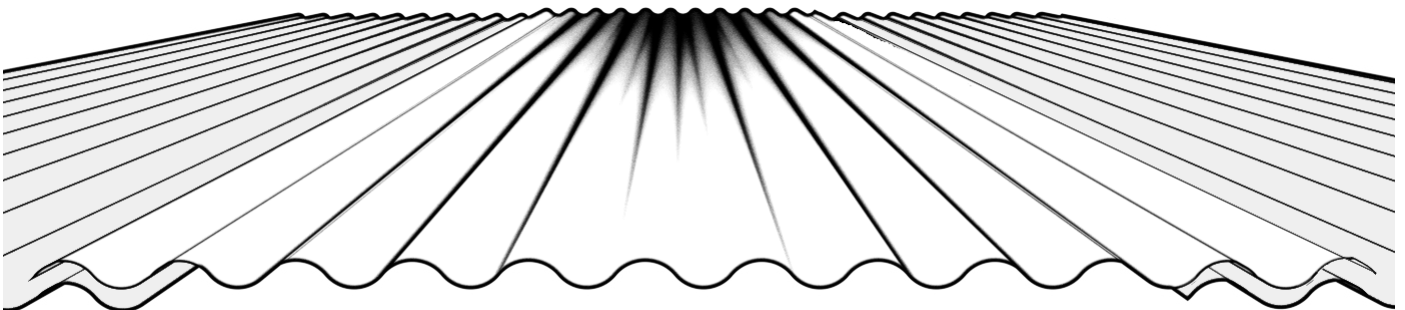

- An optional clear roof sheet (if supplied) needs to be fitted so both edges of the clear roof sheet overlap standard sheets on either side.
- For fastening clear sheet, follow the screw pattern of standard roof sheets.
- On clear sheet use dome washers under the screw heads.

## 4.3 Roof sheets fastening



- Each sheet must correctly overlap the previous sheet.
- Sheets must be 480mm past front top plate flashing (FFT001) and overlap spouting (FBS001).
- After fastening all roof sheets, ensure metal filings have been removed from between sheets, and between sheets and fasteners.

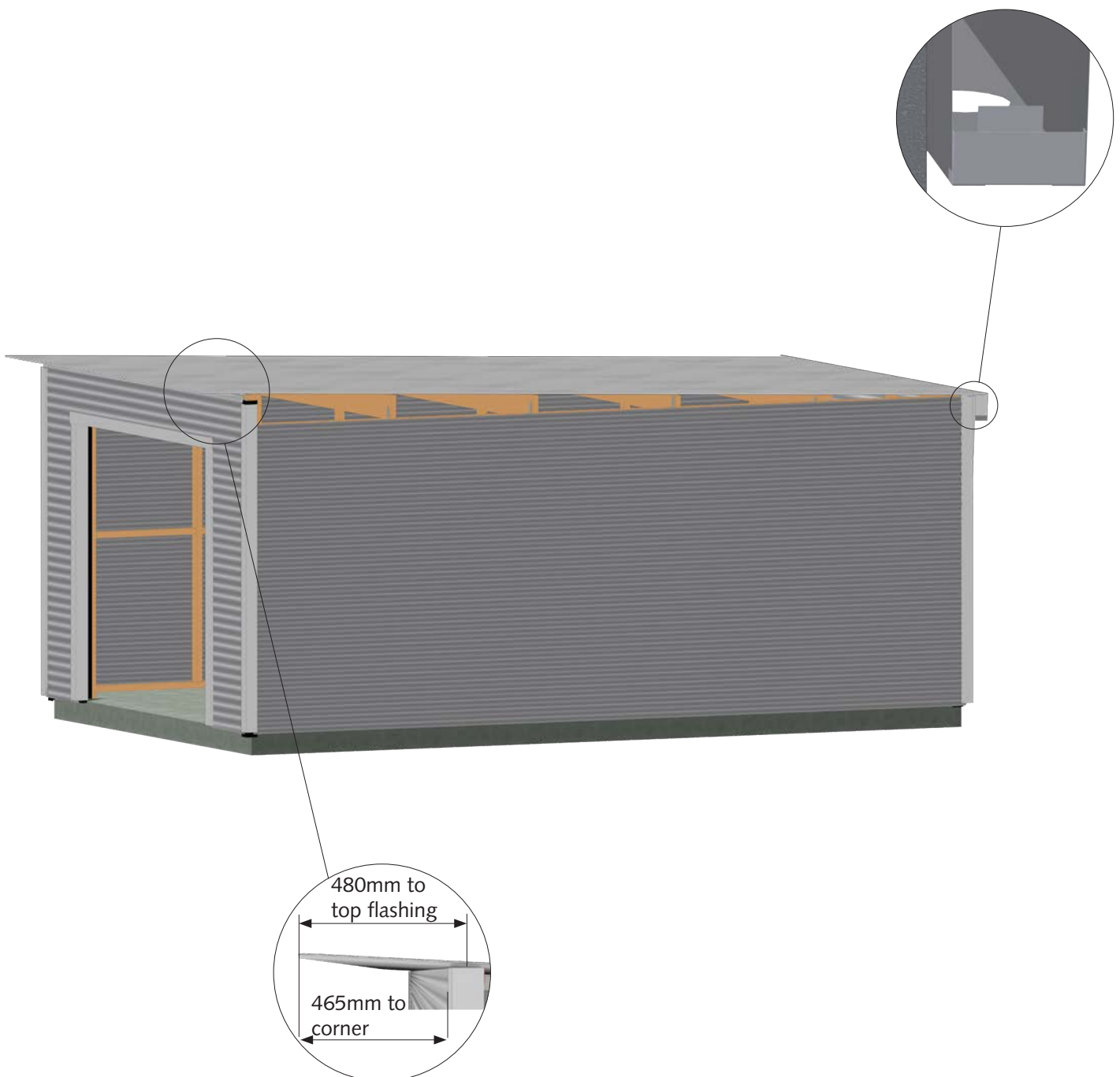

•Regarding Part IDs refer to the Parts list in pages 4 & 5.

1

Ensure top plate and ridge beams are straight before attaching roof sheets.



You may temporarily brace top plates and ridge beams to ensure they are straight, by nailing timber from packaging crate, as shown. Nail to underside if you are using building paper or netting.

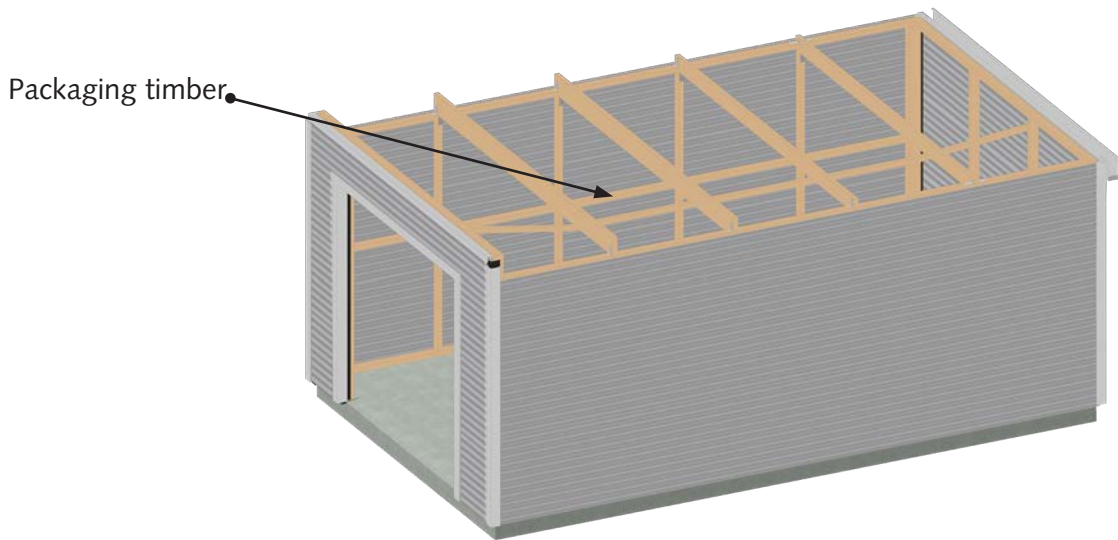

Condensation can form on underside of the shed roof. If building paper is required, fit it now. Building paper will need to be supported by netting.

2

Position first roof sheet ensuring right edge of sheet overhangs end of ridge beam by approximately 22mm, and correct front overhang of distance of 480mm from top flashing.

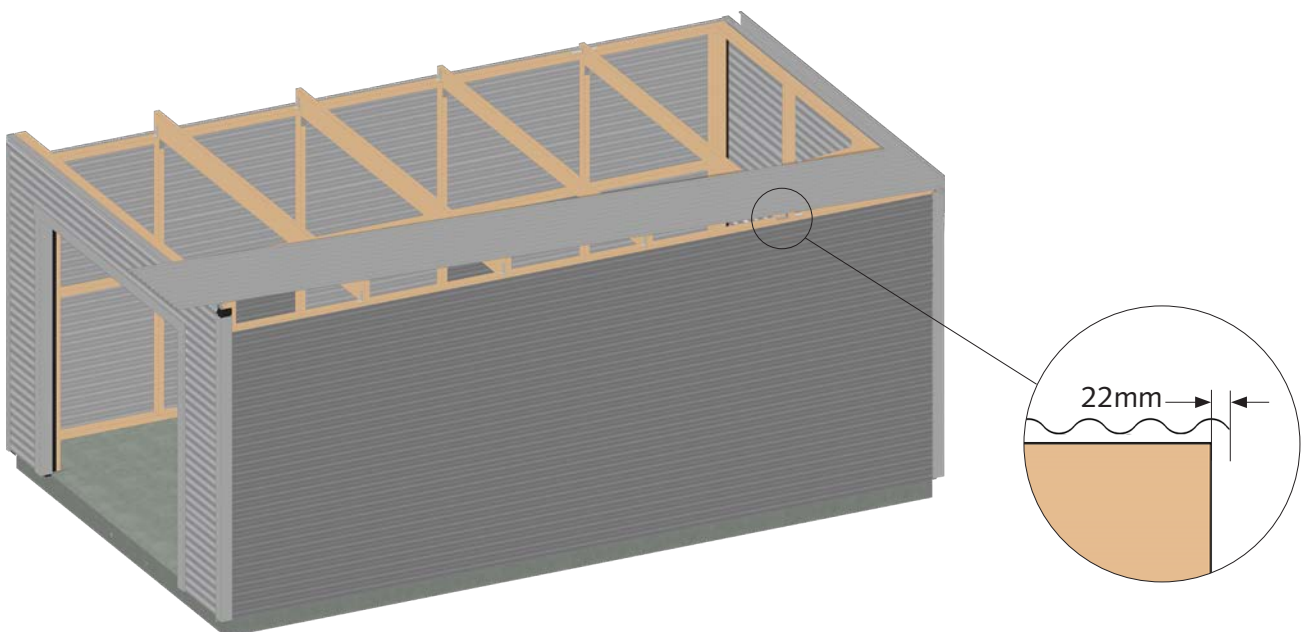

**3**

Position and attach second roof sheet ensuring correct overlap and 762mm from edge of previous sheet.

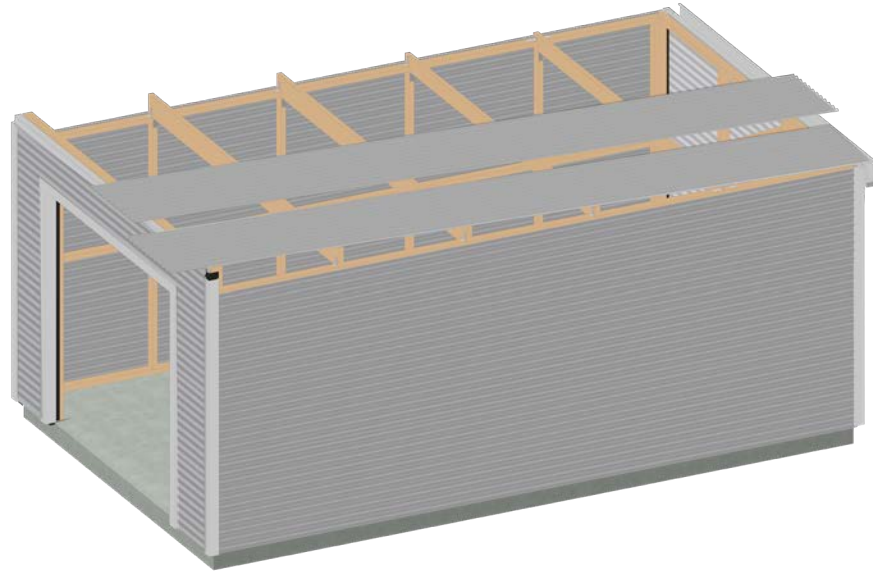

**4**

- Position and attach remaining roof sheets ensuring correct front overhang and each sheet is 762mm from previous sheet.
- Position and attach last sheet to ensure it overhangs end of ridge beams by 0-30mm.
- Remove bracing timber, after roof is attached.

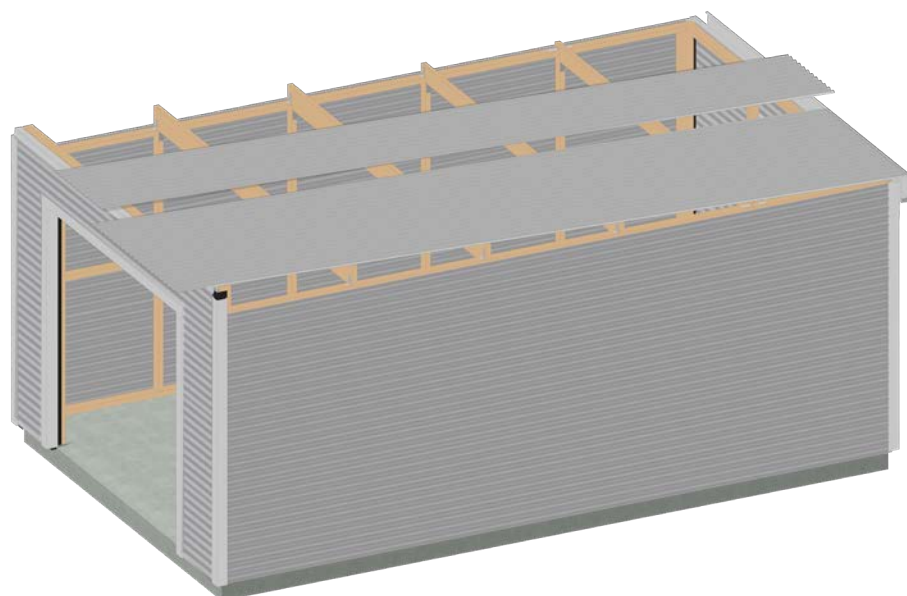



## 5. Fascia and barges attachment

### 5.1 Barge support attachment

- 1** Position barge support flashings (FB002) on each side of shed so bottom of barge support flashing is 268mm below top of ridge beams, parallel with roof slope and centrally between corner flashings.
- 2** Attach barge support to wall sheet using 5 rivets at either side.

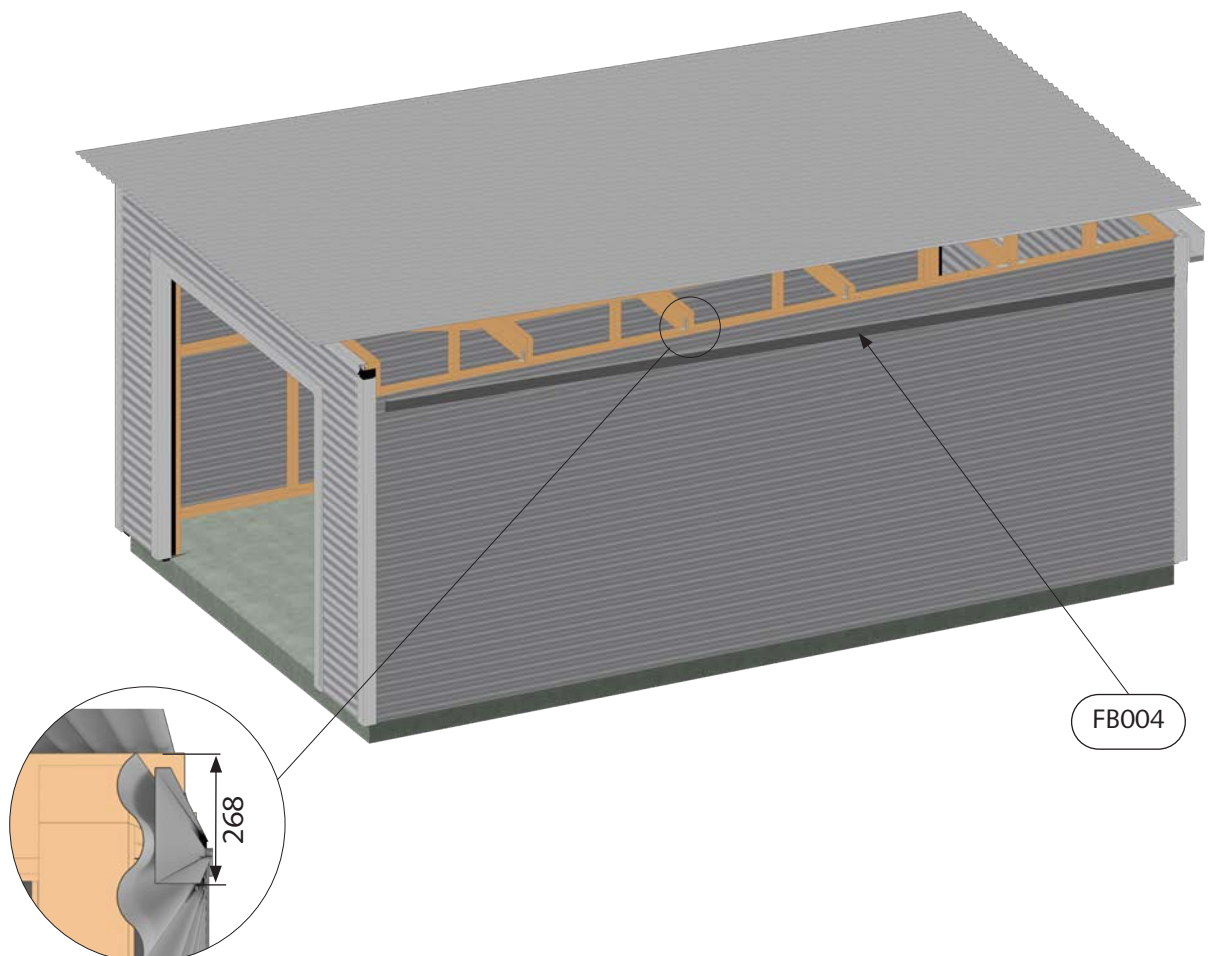

•Regarding Part IDs refer to the Parts list in pages 4 & 5.

## 5.2 Barge flashings and fascia attachment

- 1
  - Using six 55mm Hex head Tek Screws equally spaced per barge, secure barge flashings through roof sheets into the end of ridge beams and top plates.
  - Attach bottom of barge to barge support using 3 rivets equally spaced per side.

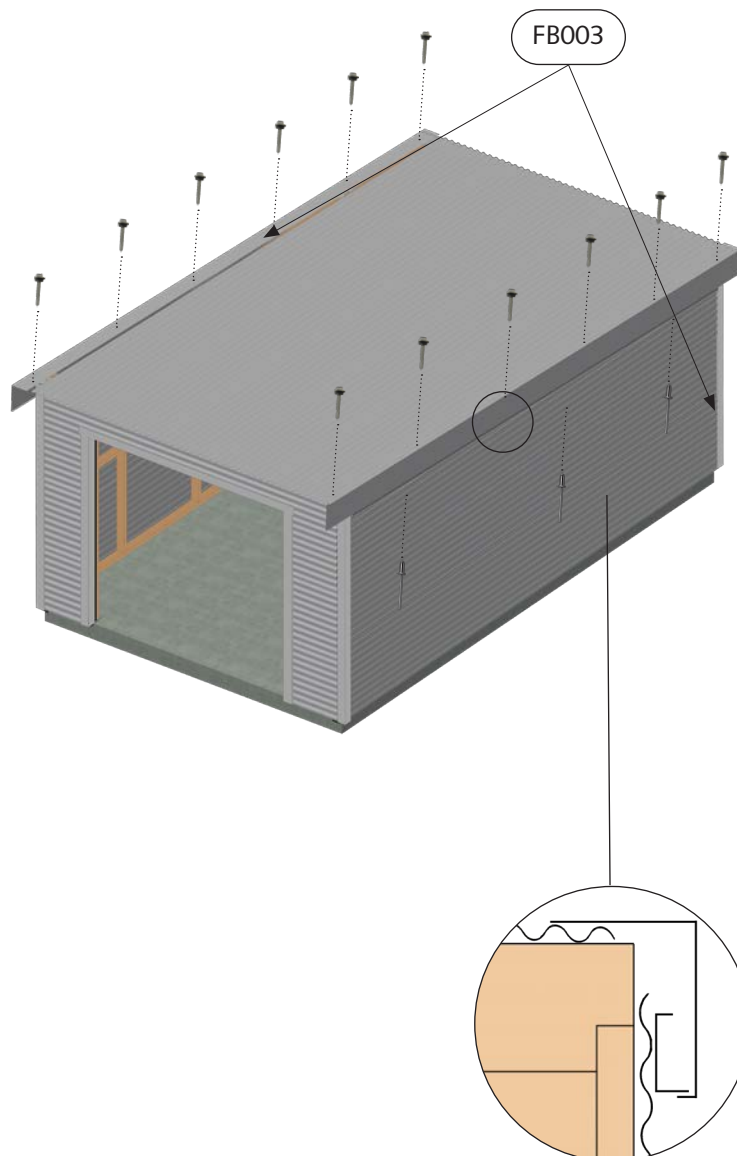

- 2** Install fascia, and screw its ends to barge flashings at both top and bottom using four 25mm Hex head Tek screws. Fasten top of the fascia to the roof sheeting, 1 Hex head Tek Screw in the centre of each sheet. Then, fasten the underneath of the fascia to the roof sheets using rivets, equally spaced, 3 rivets per sheet.

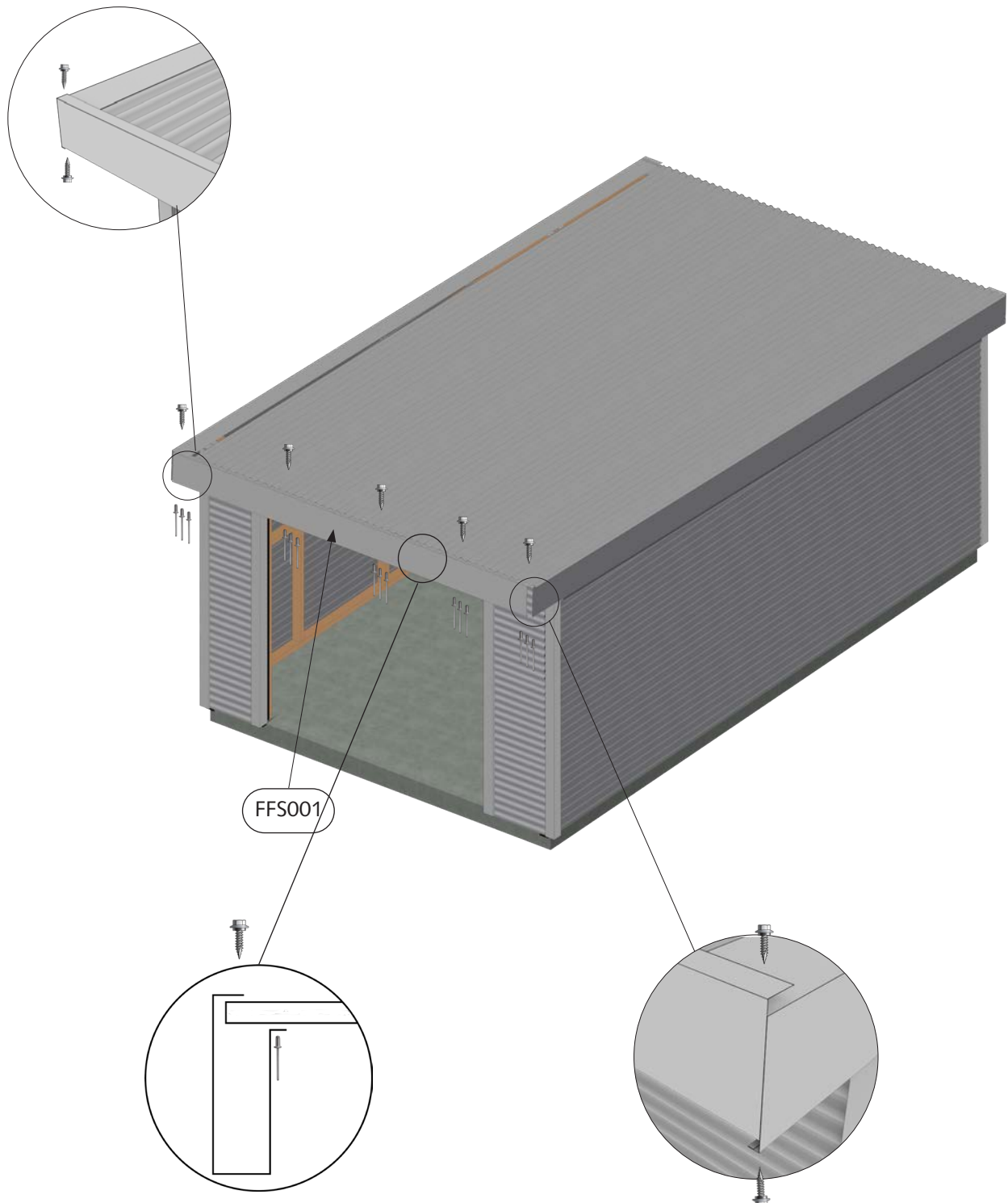

•Regarding Part IDs refer to the Parts list in pages 4 & 5.

# 6. Roller door installation

Scan this QR code to watch a video on roller door installation:

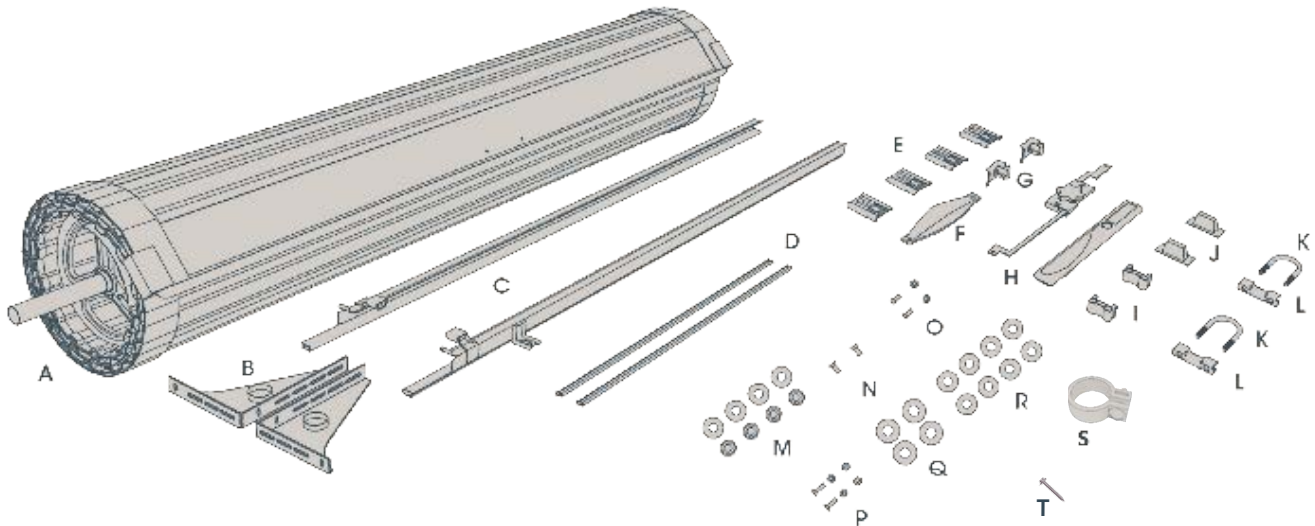
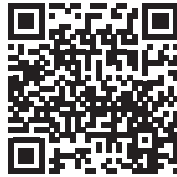

Series 1 Roll-A-Door		
Item	Description	Quantity
A	Rolled plastic wrapped door	1
B	"A" Style brackets, left and right hand	2
C	Doors guides, Left and right handed	2
D	Steel locking bars	2
Small parts bag		
E	Guide clips(door size dependant)	4
F	Door handle and fixing to suit	1
G	Bottom rail stops and 6mm screws	2
H	Faceplate and fixing to suit	1
I	Locking bar retainer	2
J	Locking bar covers	2
K	U-Bolts	2
L	Axle / Bracket saddles	2
M	8mm Nuts for Ubolts	4
N	Counter sunk screws for lock and fascia	2
O	7mm x 4mm Mushroom head screws for locking bar	2
P	4mm x 6mm Screws for handle	2
Q	10mm Washers	4
R	8mm Washers (Door size dependent)	8
S	Plastic Clamp	1
T	14gx50mm Coach screw	18

## 6.1 Brackets installation

- Position bracket (B) centre on outer stud, approximately 140mm up from bottom of lintel and 80mm from inside of door opening to outside of bracket.
- Mark 2 hole positions using the bracket's top and bottom slots.
- Drill both holes, then attach brackets using 14gx50mm coach screws and 10mm washers.
- Install second bracket as per above and make sure it is level with the first bracket.

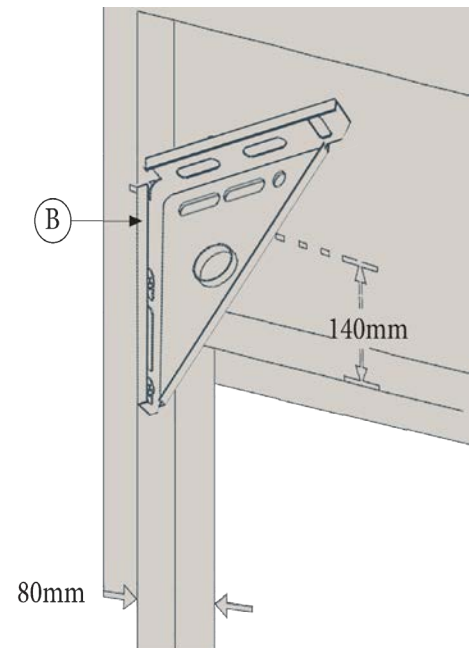

## 6.2 Door placement on brackets

Centralise shaft on roller door and fit plastic clamp onto shaft at one end to ensure shaft stays centralised.

- Do not cut plastic yet.
- Using 2 persons and correct lifting techniques, lift door onto brackets (right way around, so door will roll down from the front of the opening).
- Immediately loosely fit "U" bolts (K), saddles (L), washers and nuts (M) to the brackets in position shown.
- Fitting "U" bolts eliminates the door falling from the brackets. (Do not tighten yet.)

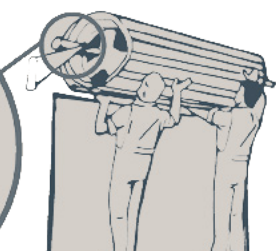
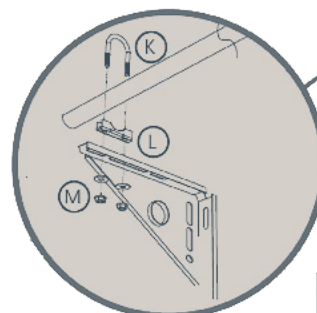
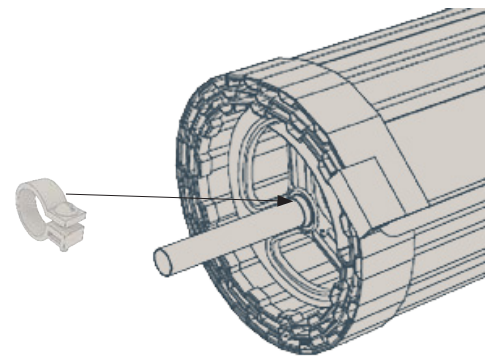

**WARNING!** practice correct lifting techniques

## 6.3 Door positioning

- Rotate the curtain and axle so that the bottom rail of the door is positioned at 3 o'clock.
- Centralise the curtain on doorway opening.
- Push the axle forward in slots (toward the opening) and tighten the nuts firmly without overtightening.

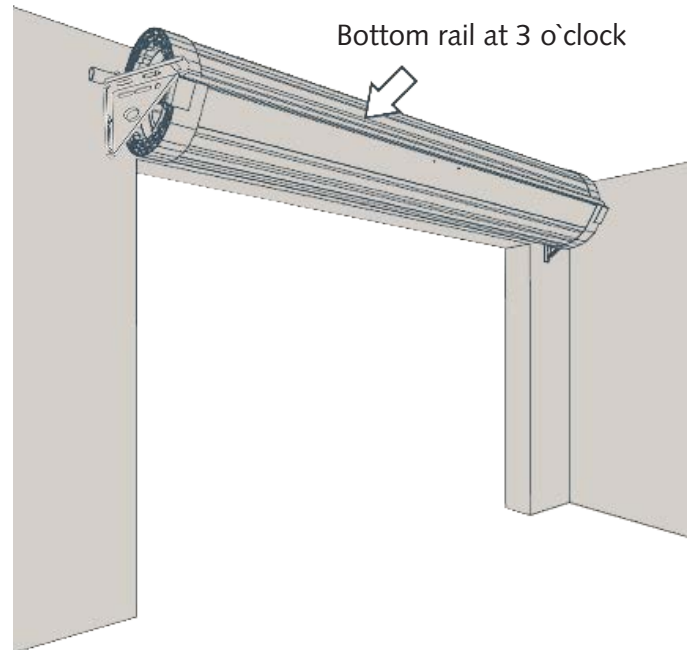

## 6.4 Springs tensioning

- Ensure the bottom rail is at 3 o'clock.
- Ensure "U" bolts are tightened, then rotate the door one turn in a forward direction to apply tension.
- Do not let go off the door, as the springs are now tensioned.
- Hold the door firmly and cut the plastic wrap along the bottom rail (take care not to damage the door surface).

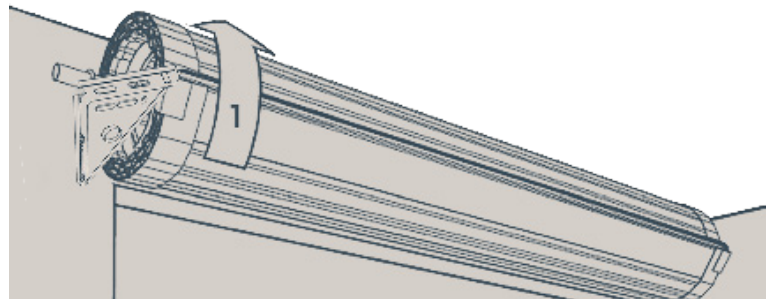

- Slowly pull the curtain down and carefully position a wooden chock (or any other appropriate stop) between bottom rail and rolled curtain as shown.
- Take care not to damage the door surface.
- Chock will hold the door until the guides and stops are in place.

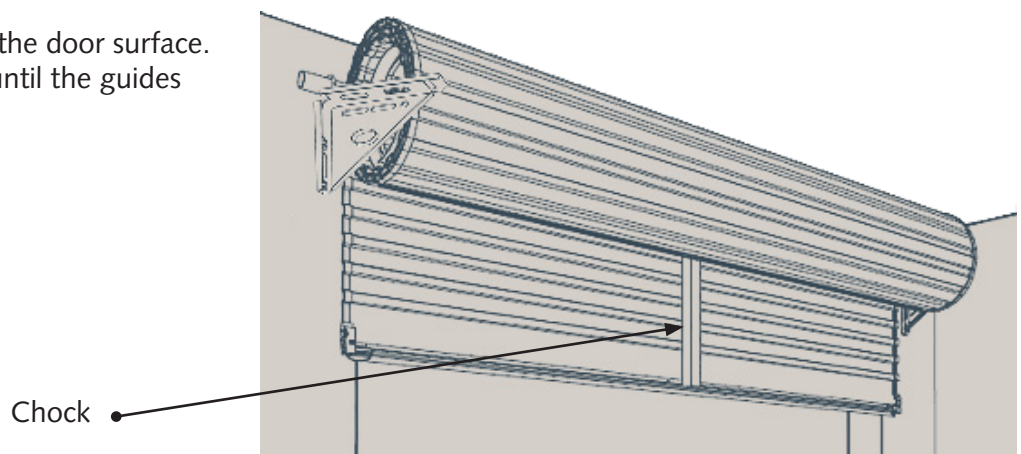

## 6.5 Bottom rail stop attachment

- Hook stop behind lip in rail.
- Secure the rail from underneath with 6mm screws (G).
- Trim weatherseal flush with end of the bottom rail.

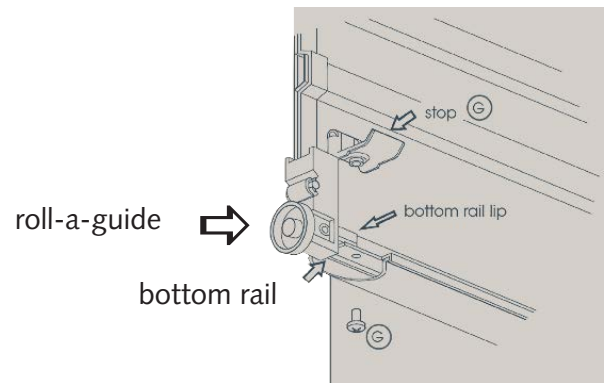

## 6.6 Guides installation

- Ensure curtain overlaps equally on both sides, and cut the guides the correct length (top of guides is level with top of the brackets while the guides bottom is touching the floor).
- Slide 2 guide clips (E) into each guide. Position the bottom clip 200mm from the floor with the rest evenly spaced along the guide.
- Position 1 guide over the edge of the door curtain. Mark and drill the top fixed guide clip and secure it using 14gx50mm coach screw and washer, allowing 3mm clearance between inside of guide and plastic roll-a-guide. Ensuring guide is plumb, fix remaining clips.

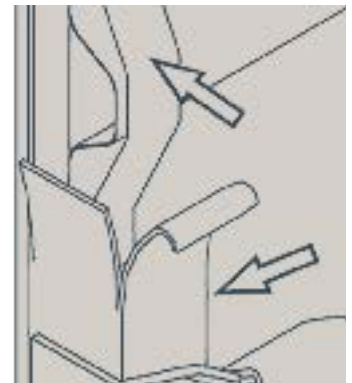

- Repeat with second guide.
- Remove the wooden chock and slowly lower the door. Removing the plastic wrap as you pull the door down. Reposition the guides as necessary to allow smooth and even operation with 0>1mm clearances.
- Ensure door curtain enters guides smoothly. It will be necessary to adjust the guide lead in to achieve this.

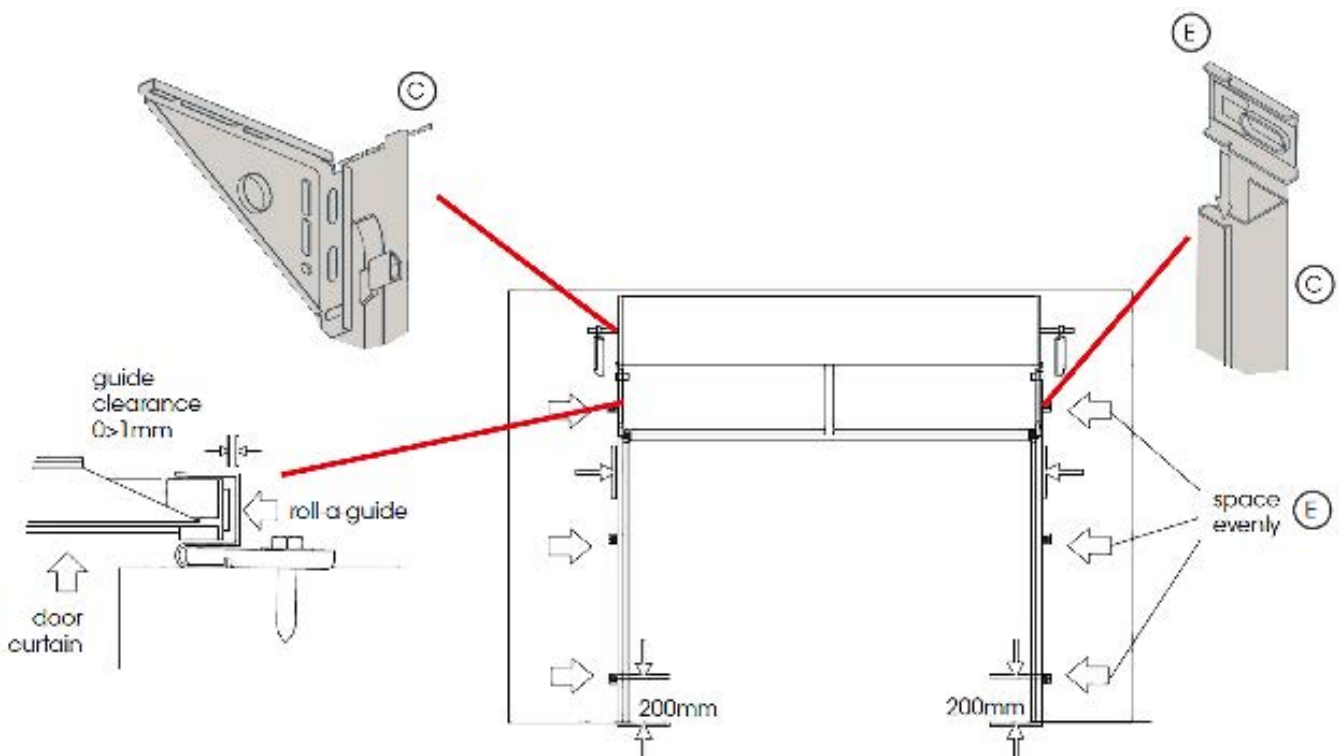

## 6.7 Handle fitment

- Fit handle (F) to the outside of the door using the supplied screws (P), nuts, and washers.
- Complete drilling holes with 5mm drill bit, through pre-drilled holes on the back of the door.

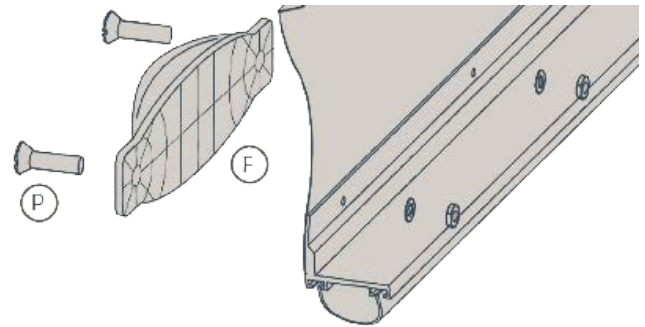

## 6.8 Lift lock centring

- Raise the curtain until the lock corrugation is visible above door guides.
- Install locking bar retainer (I) in line with lock corrugation by pushing retainer towards door edge, sliding the legs under the Nylofelt® and hooking them over the curtain edge. Ensure lock bar retainers sit squarely on door curtain.

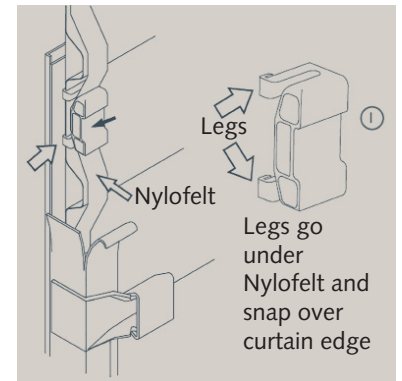

- Fit faceplate (H) to outside of door, where the hook will latch onto curtain edge. Then, slide the faceplate as far to the right as possible. Use adhesive tape on outside to hold in position.
  - Attach the lock body (H) to the faceplate from the inside, using the mounting screws and washers. Do not overtighten the screws.
  - With the door in the closed position, slide the end of the locking bars (D) through the locking bar retainers, and while holding the bars level, mark the side of the guides.
  - Drill and file out a rectangular slot no longer than 25mm and no wider than 10mm, ensuring top of the slot remains in line with top of the locking bar.
  - Slide bars through the guide slot, then back onto locking arms.
- Note:** These may need to be cut shorter.

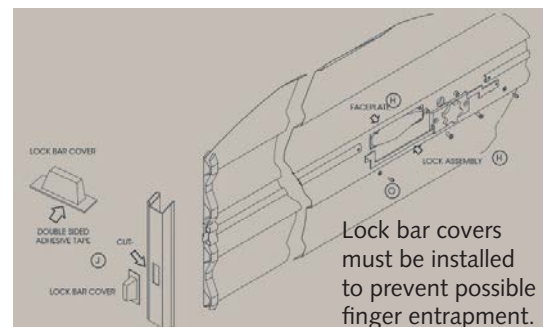
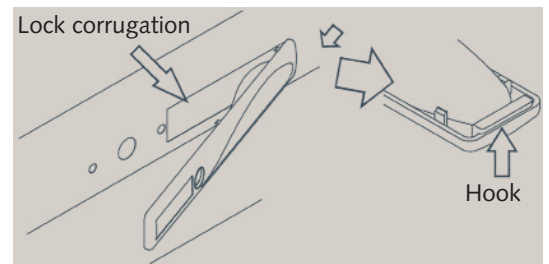

- Screw on securely using the countersunk screws (O). Ensure locking bars do not protrude more than 20mm beyond guide when engaged in locked position. It may be necessary to adjust the length of the bars.
- Ensure a clean and dry guide using clean rag.
- Peel lining from lock bar cover (J) and position over hole. Ensure locking bars move freely.

## 6.9 Clean-up

- Remove all swarf (drill filings) with a soft brush or rag.
- Hose down roof and walls thoroughly.
- For Coloursteel sheds, use touch-up paint provided on all rivets and exposed cuts.



Troubleshooting		
Symptom	Possible Cause	Remedy
Door is hard to operate in any direction	Door Jamming in the guides	Check
		a) Guide Clearances b) Guides are plumb c) Check guide surfaces are clean and free from oil d) Locking bars are correct length e) That the weatherseal is correct length
The door is hard to operate in one direction	Spring tension requires adjustment	a) If the door is hard to lift, but tends to drop, refer to section "Centralise the axle when door is mounted"
	Brackets are not level	b) If the door is hard to close, but tends to rise, refer to section "Centralise the axle when door is mounted"
The door rolls up crooked	Guides are not plumb	Make sure brackets are level. Refer to p24
	Axle is not centered	Make sure the guides are plumb. Refer to p26  Centralise the axel. Refer to section "Centralise the axel when door is mounted"

**WARNING:** Ensure pipe wrench is fitted correctly to axle and it is gripped onto the axle. Do not underestimate the tension in the spring when undoing the clamps.

**CAUTION:** This adjustment requires two persons to perform.

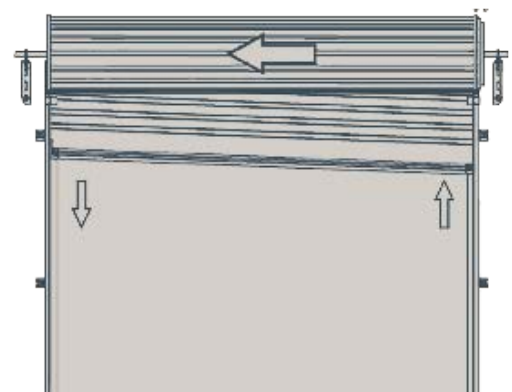
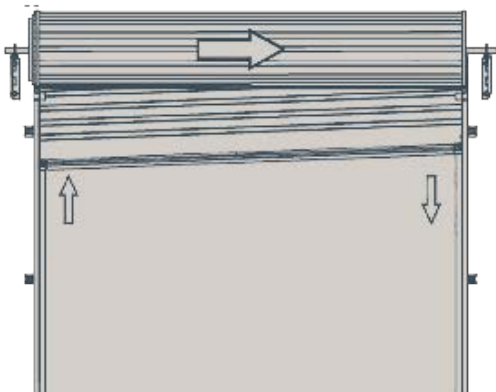

If the door rolls up crooked with one side than the other, proceed as follows:

- Roll the door up as high as possible and tie two ropes around the door roll approximately 300mm from each end, as a safety precaution.
- With a person at each end of the door, hold the axle firmly with a large pipe wrench (Stillson) at least 450mm long.
- Loosen the "U" bolt nuts at both ends and KEEP A FIRM GRIP ON WRENCH.
- Move the axle to the RIGHT between 20 - 40mm.
- Re-tighten "U" bolts before releasing pipe wrench.
- Test and repeat if further adjustment is needed.
- If the door is stiff to work or rattles over lead-in on top of guide, then refer to page 36.

## 6.11 Spring tension adjustment

**WARNING:** Ensure that pipe wrench is fitted correctly to axle and it is gripped onto the axle. Do not underestimate the tension in the spring when undoing the clamps.

**CAUTION:** This adjustment requires two persons to perform.

- With the door rolled up tie two ropes around the door roll approximately 300mm from each end, as a safety precaution.
- With a person at each end of the door, hold the axle firmly with a large pipe wrench (Stillson) at least 450mm long.
- Loosen the "U" bolt nuts at both ends and **KEEP A FIRM GRIP ON WRENCH.**
- Rotate the axle in the required direction (see diagram).
- Re-tighten the "U" bolts **BEFORE** releasing pipe wrench.
- Test and repeat if further adjustment is necessary.

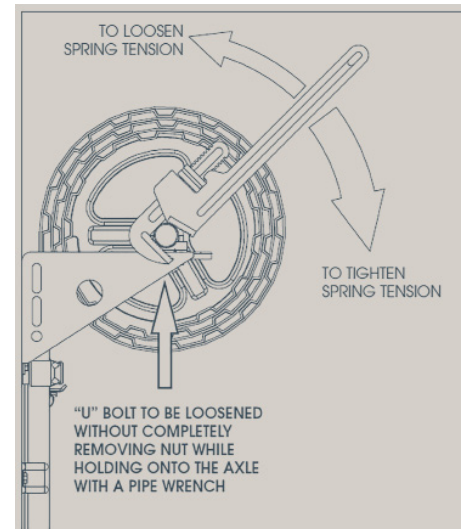

## Duratuf Lifestyle shed Triple Warranty

1. Duratuf warrants that their Lifestyle sheds will be free from manufacturing defects for **30 years**. This warranty also covers components which are missing or damaged at time of despatch from the factory.
2. Duratuf warrants the durability of the structural framing for **30 years**.
3. Duratuf warrants that the metal roofing and wall cladding will not perforate due to corrosion within the following periods:
  - Standard Non-Coastal Warranty – **30 years** if located greater than 2,000m from saltwater, or **15 years** if located between 1,000m and 2,000m from saltwater.
  - With Coastal Upgrade Option – **30 years** if located greater than 1,000m from saltwater, or **15 years** if located between 500m and 1,000m from saltwater.

### WARRANTY TERMS AND CONDITIONS

- The warranty is not transferrable and only valid for the original purchaser. Proof of purchase and proof of damage or defect is required to submit a claim. Warranty periods begin at the date of manufacture.
- This warranty is in addition to your rights under New Zealand consumer law and must be registered within 90 days from purchase to be valid. Refer to the warranty registration guidance below. All claims must be made in writing within 30 days of discovery. Interference with the product or other action taken to remedy a defect prior to Duratuf being notified of the suspected defect and Duratuf being given a reasonable time to inspect the product in situ will invalidate a claim.
- For the warranty to be valid, the recommendations in our **Kitset Care Guide** <https://www.duratuf.co.nz/kitset-care-guide/> and the **Assembly Care Instructions** given in the Assembly Instruction booklet must be followed; and the **Minimum Maintenance** in accordance with instructions below must be performed for the life of the product.
- Except as provided otherwise by NZ consumer law, the liability of Duratuf is limited to replacing or repairing any defective or missing product. Any repaired or replaced material will be covered only by the balance of the original warranty period. Duratuf will not be liable for any consequential loss or damage, or labour costs. Transport charges will apply to our nearest reseller only.
- The structural framing and cladding warranties are subject to the shed being installed on a level concrete base, or other solid supports, at least 40mm above ground level, and contact being prevented at all times with soil, vegetation, organic matter, fertilizers, or other moisture retaining substances.
- In the rare event of a claim and upon receiving proof of purchase and defect, Duratuf will at its option repair or replace defective parts, or provide a prorated refund for the remaining life of the applicable warranty. Any replacement product provided will be covered by the Warranty for the balance of the Warranty term as if the replaced product were the original product.
- Duratuf reserves the right to inspect the shed in situ at the installation site and to conduct tests at any time after a Warranty claim is received. Any interference with the shed prior to inspection by Duratuf may void a claim under this Warranty.
- Any product replaced under this Warranty becomes the property of Duratuf.
- Any failure, delay, or indulgence by Duratuf will not operate as a waiver. A waiver by Duratuf of any condition of this Warranty is not a waiver of any other condition. No waiver is effective unless it is in writing.
- All terms, conditions, warranties, undertakings, inducements, and representations other than contained in this warranty, whether express or implied, statutory, or otherwise, are expressly excluded.
- This Warranty does not exclude, restrict, or modify any liability that cannot be excluded, restricted, or modified at law.

### EXCLUSIONS FROM WARRANTY COVER

- Normal wear and tear. Fading, chalking, or discolouration of the cladding. Minor white corrosion at cuts or bends.
- Cladding perforation in areas where severe or very severe environmental situations are extended inland by local conditions.
- Timber floors less than 40mm above ground level, or where used for storage of other than normal lightweight household items.
- This warranty will not apply if the failure or defect is caused or contributed to by an event or action beyond the reasonable control of Duratuf, including without limitation:
  - Mechanical, chemical, or other damage sustained after despatch from Duratuf's factory.
  - Problems resulting from misuse or use for purposes other than normal dry storage use.
  - Fire, flood, storm, cyclone, earthquake or other 'Acts of God.'

### MINIMUM MAINTENANCE REQUIREMENTS

- All metal swarf must be cleaned off the shed IMMEDIATELY.
- Wash all external surfaces using a soft nylon brush with water every 12 months, or for locations within 2 km of saltwater, wash every 3 months. After a storm, wash the cladding and the gutters as soon as possible to remove any salt deposits.
- A low-pressure water spray may also be used, less than 10 MPa (1500 psi or 100 Bar).
- Outdoor cleaning detergents may be used if they do not contain bleach, chlorine, or other harmful chemicals.
- Volcanic ash fallout and pollen deposits—wash as soon as possible, removing all deposits from roof and gutters.
- Gutters and channels to be kept clear of leaves and dirt at all times.
- Remove any lichen or mould: First wash off any loose growth with a brush and water. Apply diluted bleach (sodium hypochlorite) at 2% solution. A small amount of household detergent (no more than 5-7 ml per litre of water) may be added to the solution to improve wetting. Leave for 5 minutes. Wash down with copious amounts of clean water.
- Remove and replace any fasteners, washers, or fittings showing signs of corrosion.

## Warranty registration

Go to <https://duratuf.co.nz/warranty> to register the Warranty within 90 days of purchase. Alternatively, call us on 0800 438 274. It is important to keep your proof of purchase as it will be required in the unlikely event of a claim. Many thanks, from the team at Duratuf.

**Thank you for investing in a Duratuf Lifestyle Range Shed.**

