

# Raglan

## Assembly Instructions

Base size: 4000 x 2500



Kitset care guide:





<b>Required tools</b>	2
<b>Before you start</b>	3
<b>Safety precautions</b>	3
<b>Select your site</b>	3
<b>Warranty requirements</b>	3
<b>Parts list</b>	4
<b>Hardware list</b>	6
<b>Base specifications</b>	7
<b>1. Timber frame assembly</b>	8
1.1 Back wall assembly	9
1.2 Side walls assembly	10
1.3 Front wall assembly	11
1.4 DPC attachment to bottom plate	12
1.5 Joining walls to each other	13
1.6 Ridge beam and door head flashing attachment	14
1.7 Timber frame to base securement	15
1.8 DPC attachment to studs	17
<b>2. Cladding attachment</b>	18
2.1 Side and back walls cladding attachment	19
2.2 Front wall cladding attachment	21
<b>3. Flashing attachment</b>	23
3.1 Top plate and door flashing attachment	23
3.2 Corner flashings attachment	24
3.3 Spouting assembly	25
3.4 Spouting attachment	26
<b>4. Roof sheets attachment</b>	27
4.1 Layout for fastening roof sheets	27
4.2 Optional clear roof sheet attachment	27
4.3 Roof sheets fastening	28
<b>5. Fascia and barges attachment</b>	31
5.1 Barge flashings and fascia attachment	31
<b>6. Ranch slider attachment</b>	33
<b>Duratuf Lifestyle shed warranty</b>	34

# Required tools



Riveter



Pipe wrench



Caulking gun



Tin snips (left & right hand)



Hacksaw



Adjustable spanner



Flat file



Hand saw



Hammer



Level



Utility knife



Cordless drill screwdriver



- Hex drive 5/16
- Hex drive 3/8



Phillips drill bit



Square drive drill bit



Slotted drill bit



Ladder



- Drill bit 3.5mm
- Drill bit 7mm



Hammer drill and 10mm and 12mm masonry bits



Tape measure



String line



## Before you start

- Read all instructions carefully.
- All dimensions are in millimetres.
- 2 people are required for shed install.
- Ensure all parts are included and you have access to all required tools.
- Engineering drawings and producer statements are available on the Duratuf website.

## Safety precautions

- Do not attempt to build your shed in high winds.
- Wear work gloves, and ear and eye protection when assembling.
- Be cautious of sharp edges when handling parts.
- Use electric tools with care. Use a Safety Trip Switch.
- Ensure safety requirements are met when working with ladder. For more information visit:  
<https://www.worksafe.govt.nz/topic-and-industry/working-at-height/safe-working-with-ladders-and-stepladders-construction/>.

## Select your site













- Site must be level, with appropriate access around shed for installation.











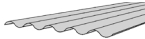
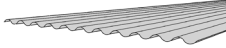
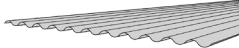
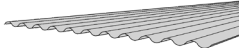
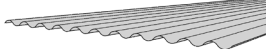
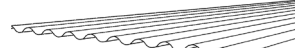







## Warranty requirements













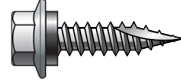

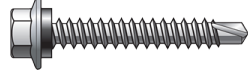
The maintenance process on the back page of these instructions needs to be adhered to, to qualify for the steel warranty of your shed. The following precautions must be carefully observed during installation:

- Do not allow manures, chemicals or other corrosive materials to have direct contact with cladding.
- All metal filings (swarf) must be removed immediately after assembly.
- Avoid contacting steel with sunscreen or pencil, as this could damage the steel cladding.
- Keep structural framing and cladding at least 40mm above ground level.

# Parts list

Part ID	Part name	Timber size (mm)	Qty	Length (mm)	Diagram	Checked	Packed
TB013	Bottom plate-13	70x45	2	4000			
TT012	Top plate-12	70x45	2	4000			
TB014	Bottom plate-14	70x45	2	2360			
TT013	Top plate-13	70x45	2	2360			
TN019	Nog-19	70x45	2	1154			
TN055	Nog-55	70x45	2	731			
TN051	Nog-51	70x45	4	1112			
TN052	Nog-52	70x45	2	662			
TS030	Stud-30	70x45	4	2400			
TS033	Stud-33	70x45	3	308			
TS037	Stud-37	70x45	11	2250			
TS038	Stud-38	70x45	2	2000			
TL007	Lintel-7	70x45	2	2490			
TR033	Ridge beam-33 (70Lx73H Tongue)	140x45	1	4000			

Part ID	Part name	Qty	Length (mm)	Diagram	Checked	Packed
	Front wall half sheet	1	4000			
	Front wall sheet	6	800			
	Side wall sheet	6	2500			
	Back wall sheet	3	4000			
	Roof sheet	5	3100			
	Optional clear roof sheet		3100			
FDH004	Door head flashing-4 (Raglan)	1	2400			
FBS006	Spouting-6	1	4125			
FS001	Spouting end cap	2				
FBC001	Back corner flashing-1	2	2365			
FB010	Barge flashing-6	2	3175			
FF007	Fascia-7	1	4125			
FFT006	Front top plate flashing-6	1	4000			
FDP001	Downpipe cover flashing	1	2160			
RSBF001	Ranch slider front panel back flashing	2	2140			
FDJ003	Ranch slider door jamb flashing	2	2140			
FFC002	Front corner flashing-2	2	2515			
FDF004	Ranch slider door top flashing	1	2600			
	Gutter strap	2	200			
	PVC downpipe	1	3000			
	Ranch slider door, trim 2050x2405	1	2400			
	Damp proof course (DPC)	1				
	Dropper and sleeve	1				
	Downpipe bracket	2				

Part name	Quantity	Diagram
30mm clout nails (cladding)	210 pcs	
90mm nails (framing)	160 pcs	
Rivets	80 pcs	
25mm Hex head Tek Screw (coloured/zinc)	220 pcs	
35mm Hex head Tek Screw (zinc)	16 pcs	
50mm countersunk stainless steel screw	12 pcs	
55mm Hex head Tek Screw (coloured/zinc)	110 pcs	
100mm Hex head Tek Screw (zinc)	18 pcs	
"L" bracket	4 pcs	
M10 x 140 screw bolts (blue head)	4 pcs	
M12 X 135 through bolt	18 pcs	
Purlin concealed cleats 86x40mm	6 pcs	
Dome washer (for clear roof sheet)	20 per clear sheet	
Silicone tube	1	
Retouch paint bottle	1	
Retouch brush	1	

# Base specifications

Use the below specifications to build a concrete base for shed:

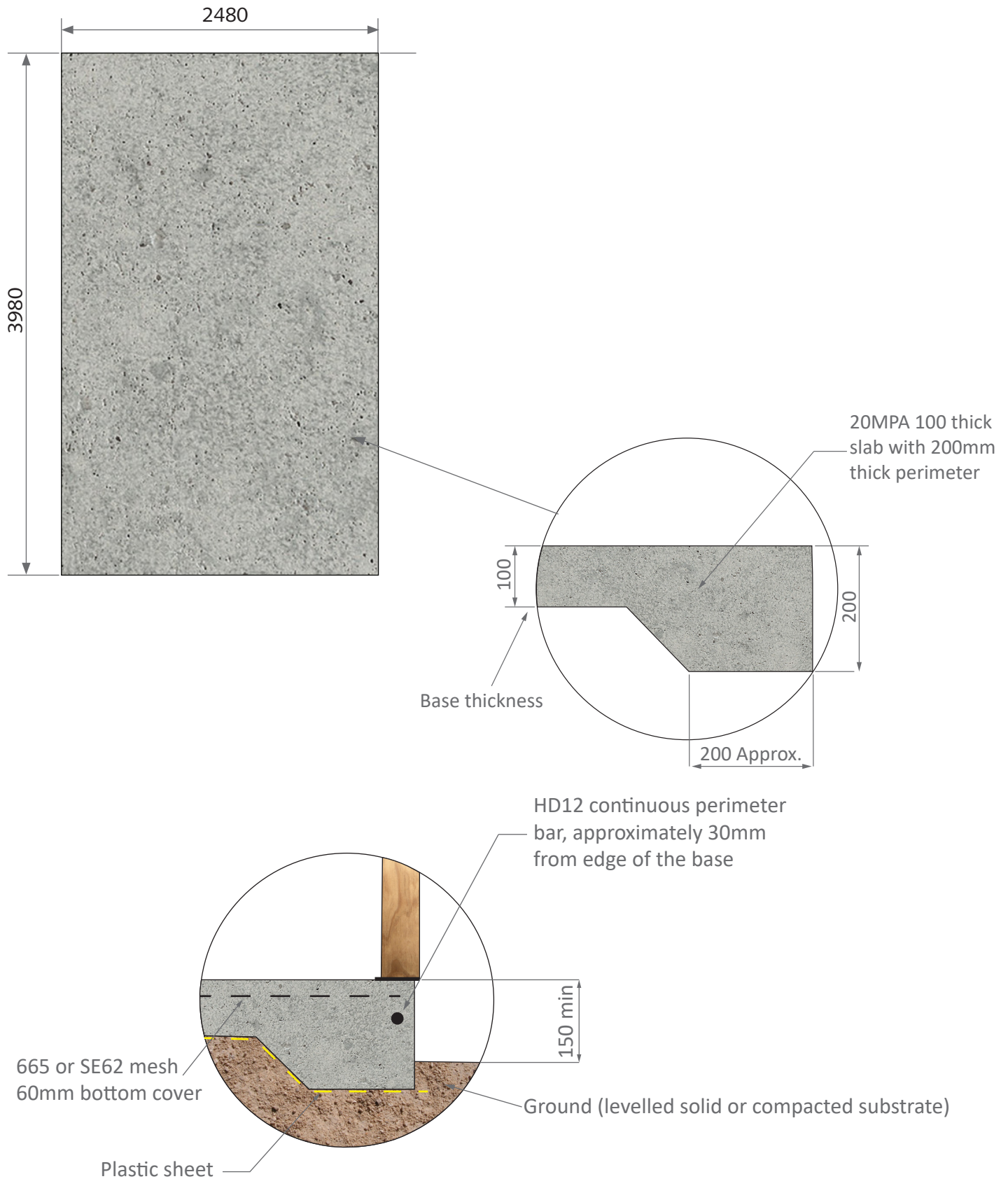

- Concrete to NZS 3101

# 1. Timber frame assembly



- Arrange the parts specified in the following steps on a flat surface and attach them together using two 90mm nails at each join.
- Studs should be positioned between top and bottom plates.

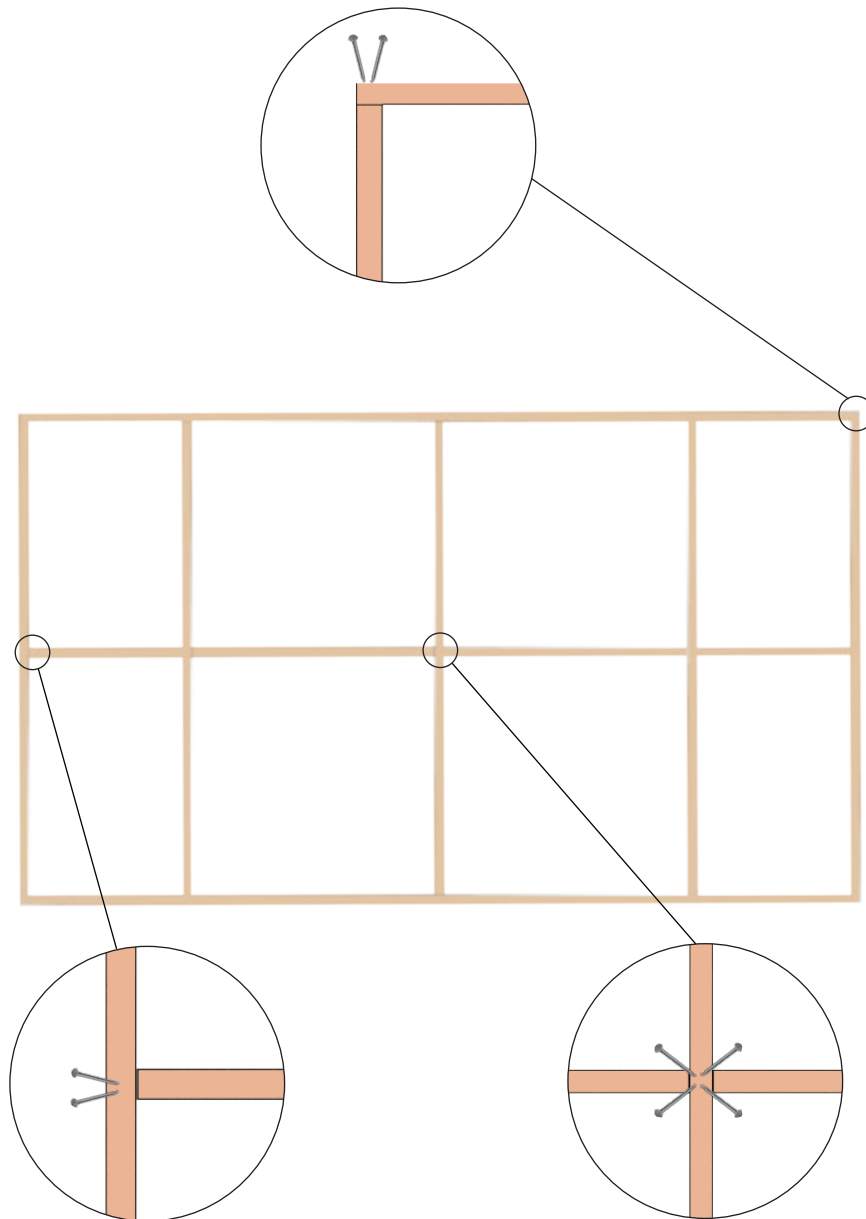

## 1.1 Back wall assembly

- 1** Nail top and bottom plates to end studs.

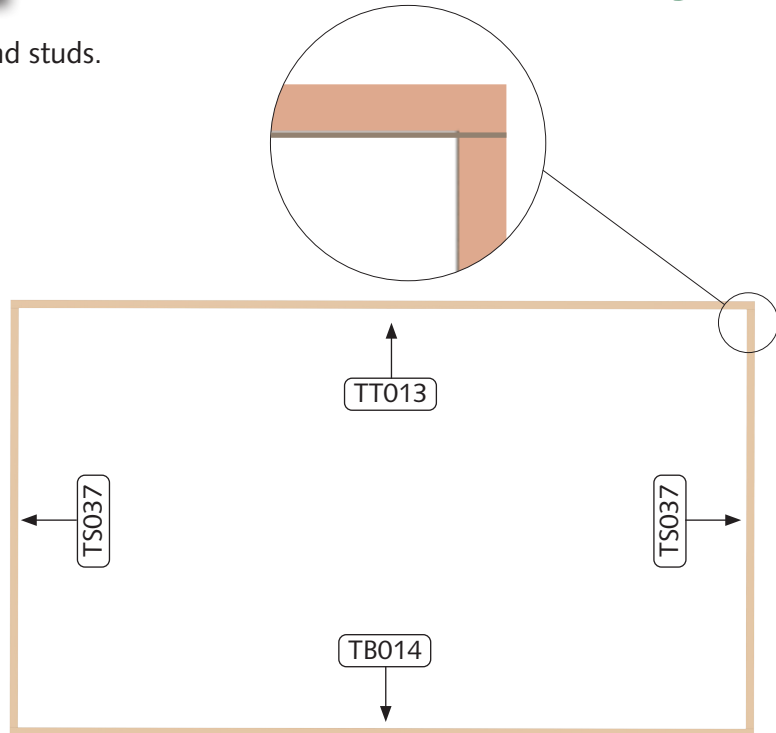

- 2** Nail remaining studs in correct position.

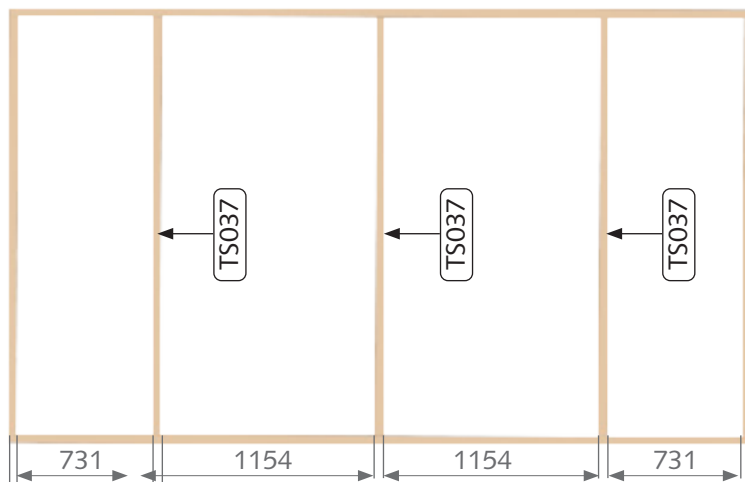

- Use nogs to get correct spacing.
- End nogs may need to be trimmed due to stud thickness.

- 3** Nail in nogs at correct height.

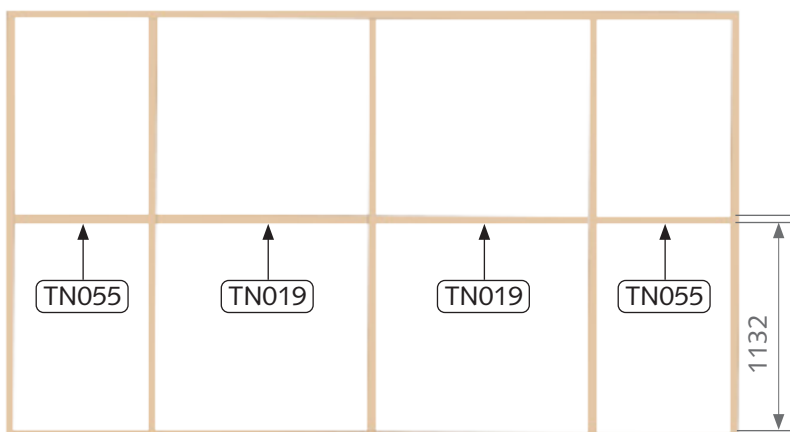

•Regarding Part IDs refer to the Parts list in pages 4 & 5.



## 1.2 Side walls assembly

- 1 Nail top and bottom plates to end studs.

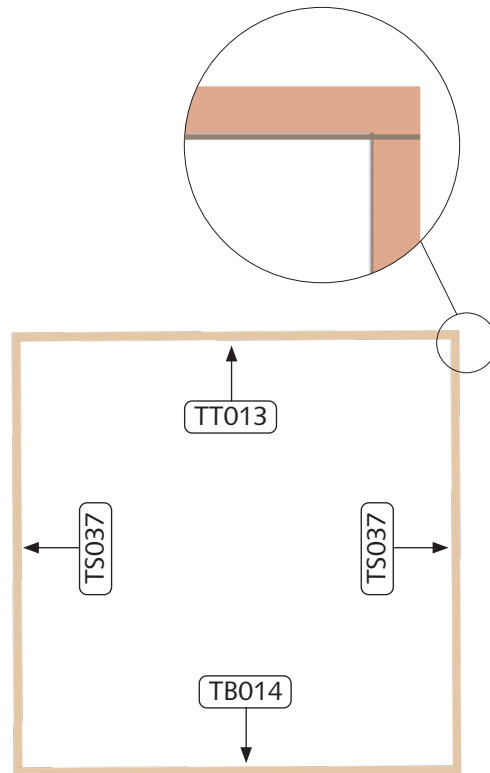

- 2 Nail remaining studs in correct position.

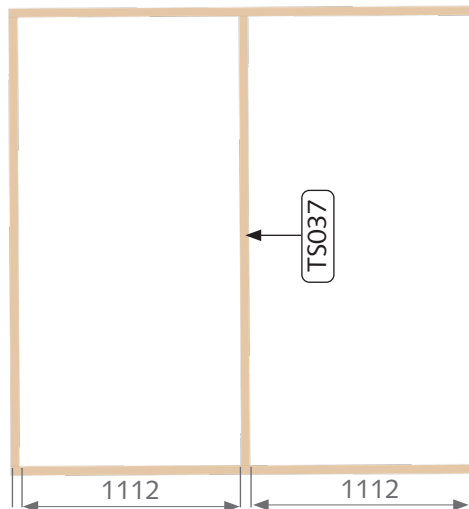

- 3 Nail in nogs at correct height.

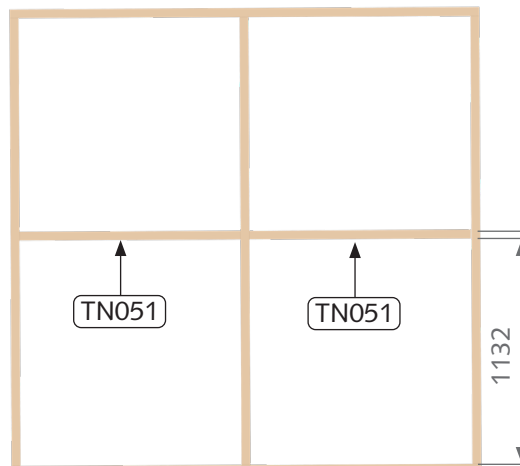

•Regarding Part IDs refer to the Parts list in pages 4 & 5.

## 1.3 Front wall assembly

**1** Nail top and bottom plates to end studs.

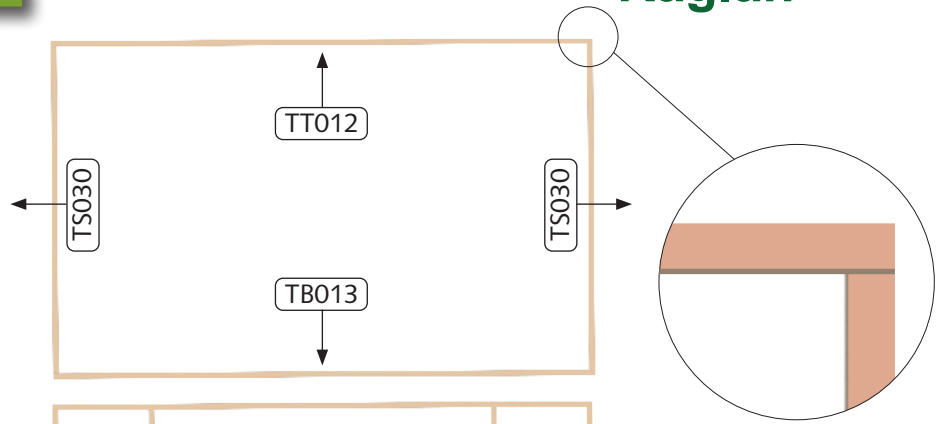

**2** Nail remaining studs in correct position.

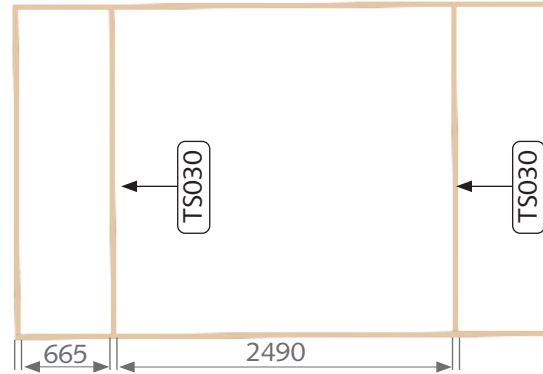

**3** Nail in noggs at correct height.

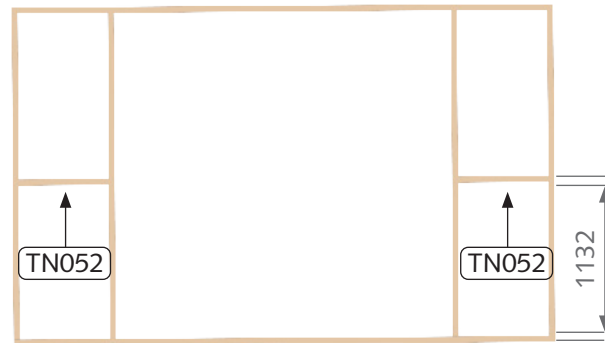

**4** Nail shorter studs each side of doorway, using 4 nails evenly spaced into longer stud and 2 nails through bottom plate. Nail lintels (TL007) together, then to studs at each end.

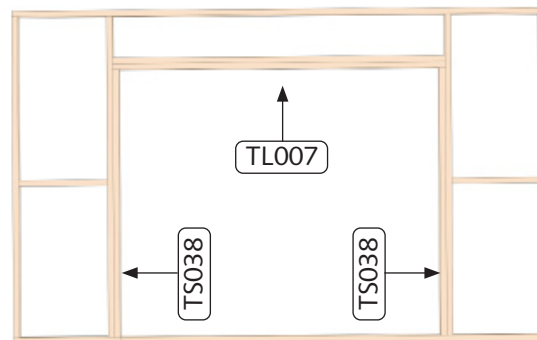

**5** Nail studs above doorway to top plate and lintel.

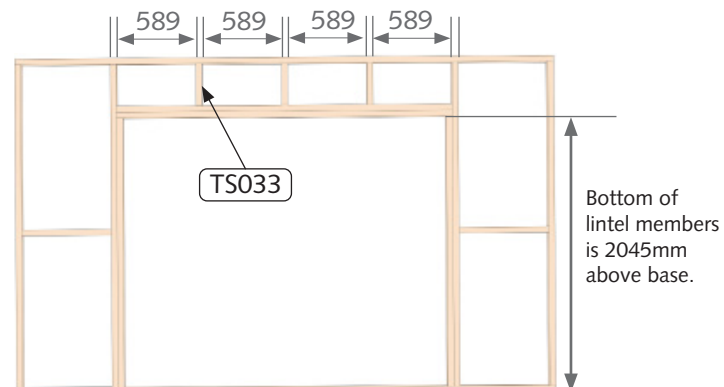

•Regarding Part IDs refer to the Parts list in pages 4 & 5.

## 1.4 DPC attachment to bottom plate

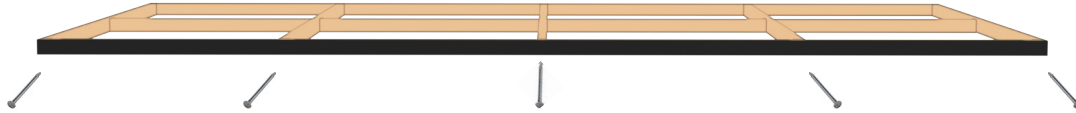

Cut pieces of the DPC roll to the length of each wall panel and nail them to underside of bottom plate on wall panels (using 30mm clouts underneath each stud, flush with the outside edge of the bottom plate).



## 1.5 Joining walls to each other

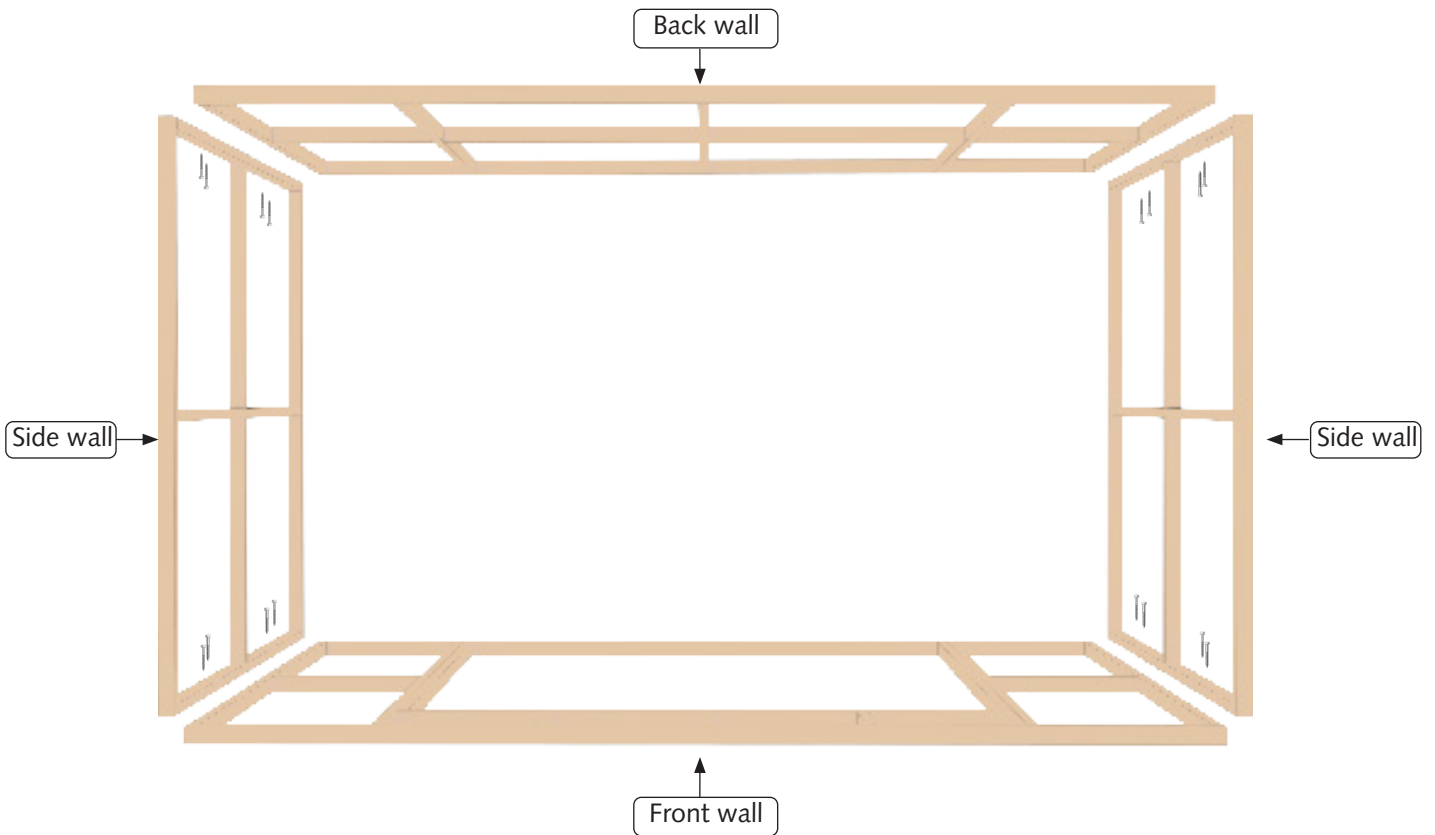

**1**

Pre-drill side wall frames as shown using 7mm drill bit.



100mm Hex head Tek Screw



**2**

Screw frames together using a cordless drill screwdriver and four 100mm Hex head Tek Screws at each corner.

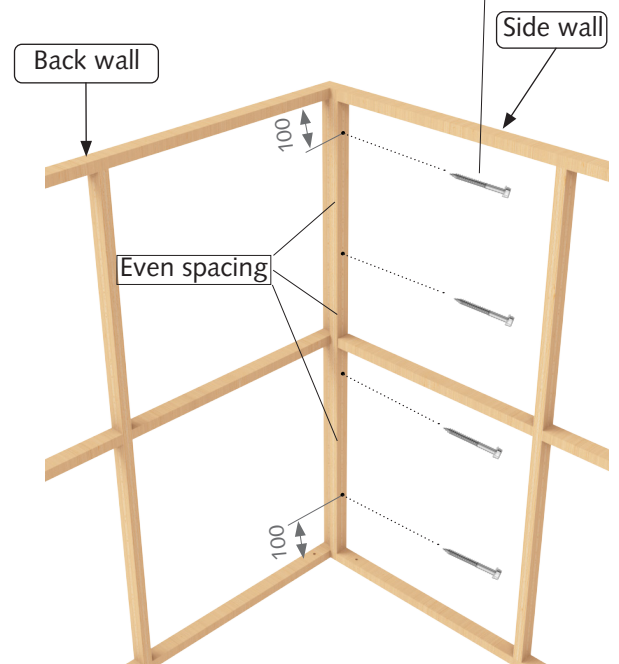

## 1.6 Ridge beam and door head flashing attachment

- 1 Fix each ridge beam's 2 ends to the side walls above each stud, using 3 cleats (2 at the top and 1 underneath) and four 25mm Hex head Tek Screws, per cleat.

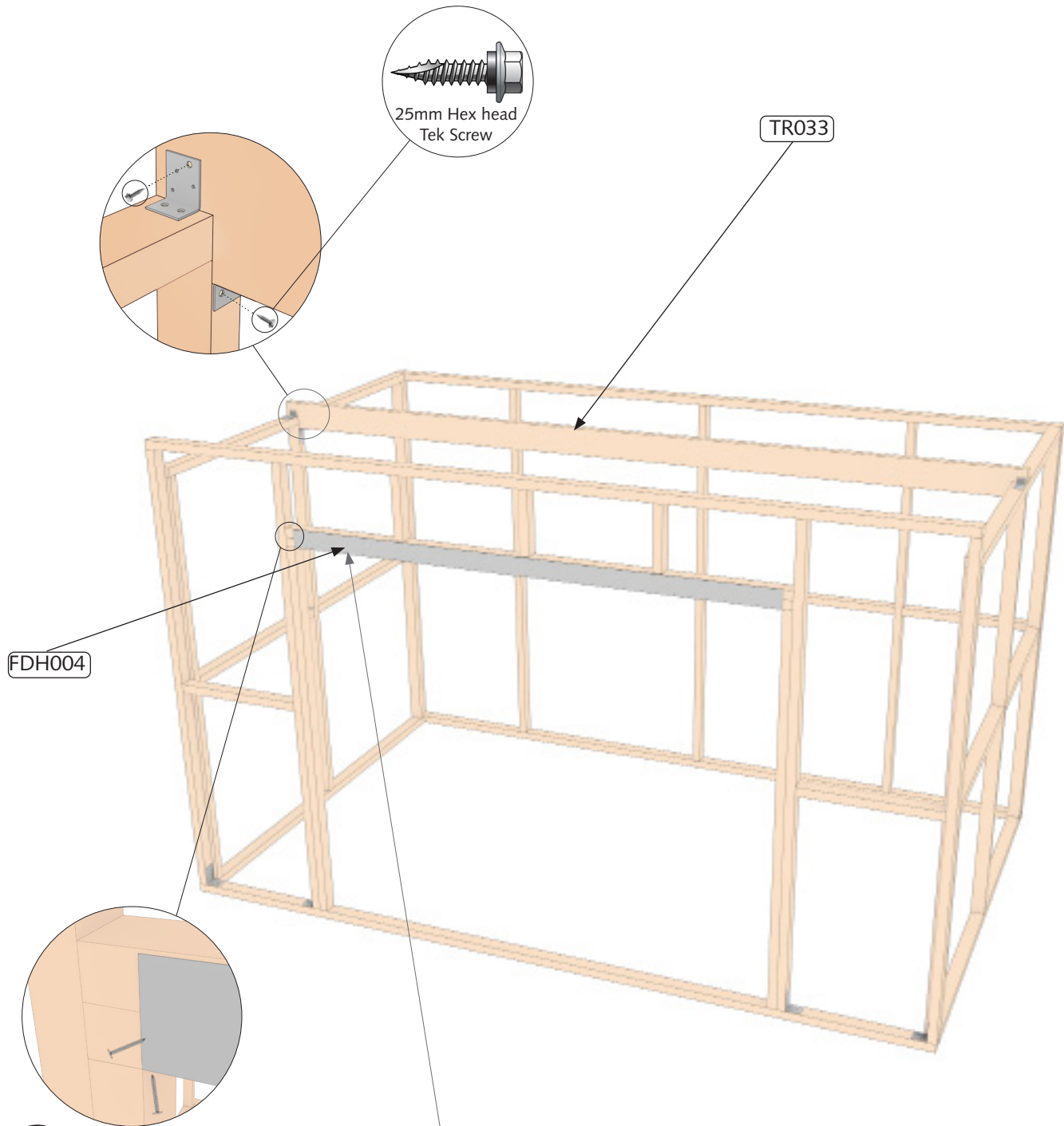

- 2 Attach door head flashing (FDH004) to the front wall using six 30mm clouts (3 outside, 3 underside).

## 1.7 Timber frame to base securement

- 1 Adjust the frame to get a 10mm overhang on all 4 sides. Then, make sure diagonal measurements as shown are the same, to ensure frame is straight and square.

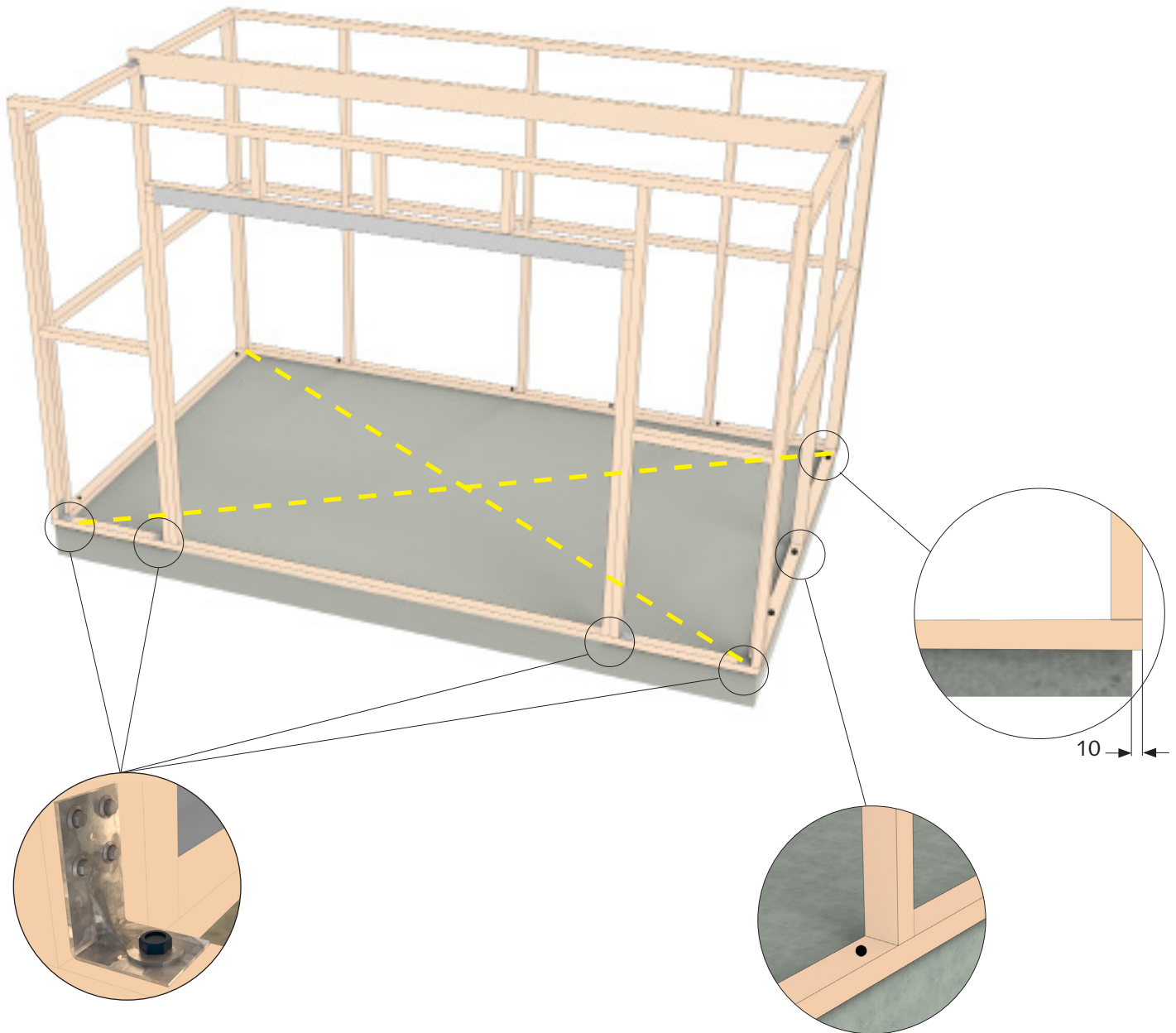

- 2 Only on the front wall, position the four "L" brackets as shown and pre-drill 4 holes approximately 35mm from the outermost and innermost studs through bottom plate and concrete base using hammer drill and 10mm masonry drill bit. Secure 4 "L" brackets to studs using four 35mm Hex head Tek Screws and to the concrete base using M10 x 140 screw bolts.
- 3 Pre-drill a hole within 50mm from one side of studs as shown, through timber and concrete base using hammer drill and 12mm masonry drill bit (17 holes in total). Fasten timber frame to the base through the holes using M12x135 through bolts.

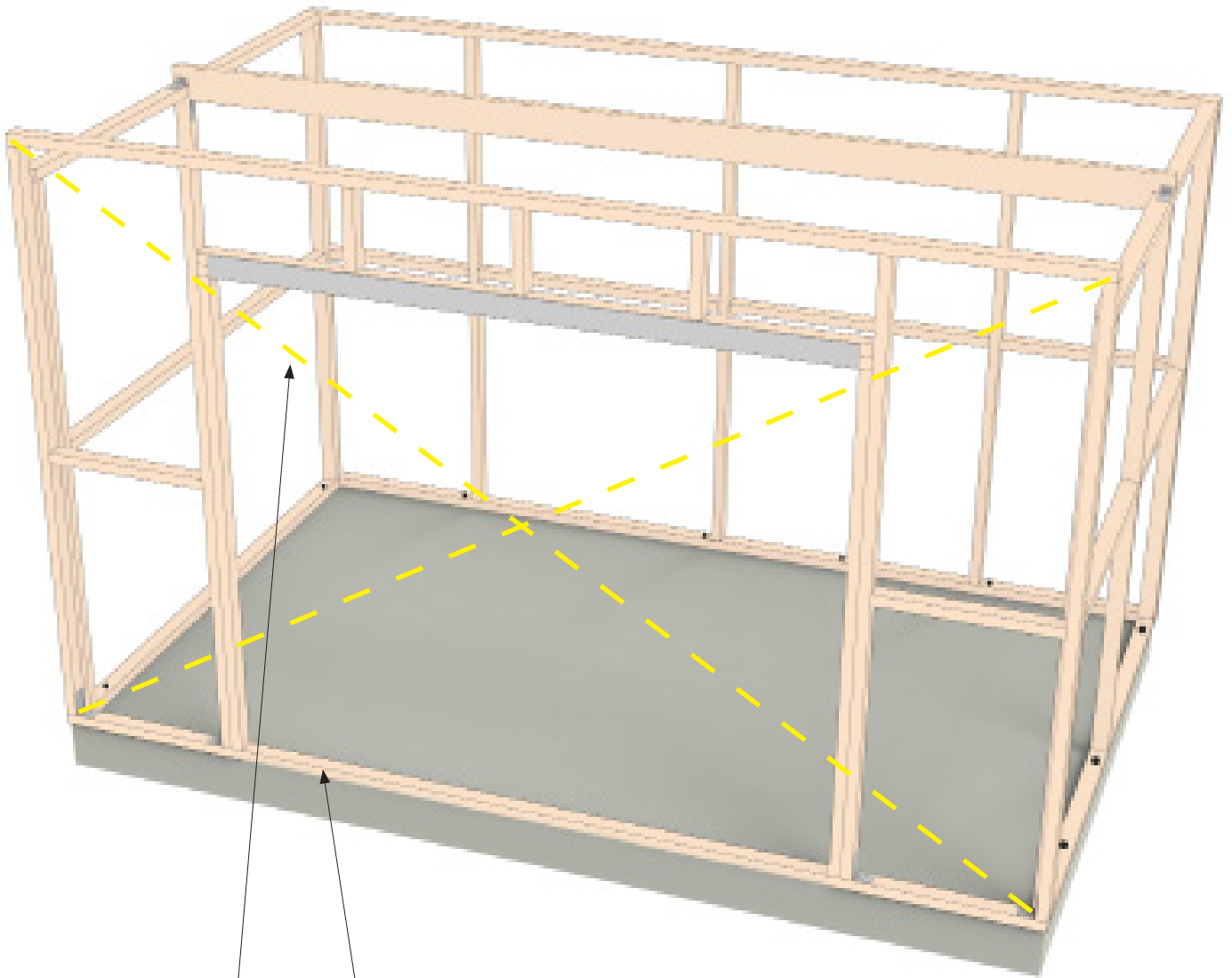

- Ensure diagonal measurements on each wall frame are the same.
- Use packaging timber (or similar) as bracing and nail to inside of frame to temporarily hold wall panel square.

**4**

Cut bottom plate between door studs using a hand saw (flush with inside of front wall studs).



## 1.8 DPC attachment to studs

- Using ten 30mm clouts, attach DPC folded around each corner as shown. DPC should be level with top of top plate and bottom of bottom plate.
- Repeat above, attaching DPC folded around front corner of door studs with top of DPC level with underside of lintel.

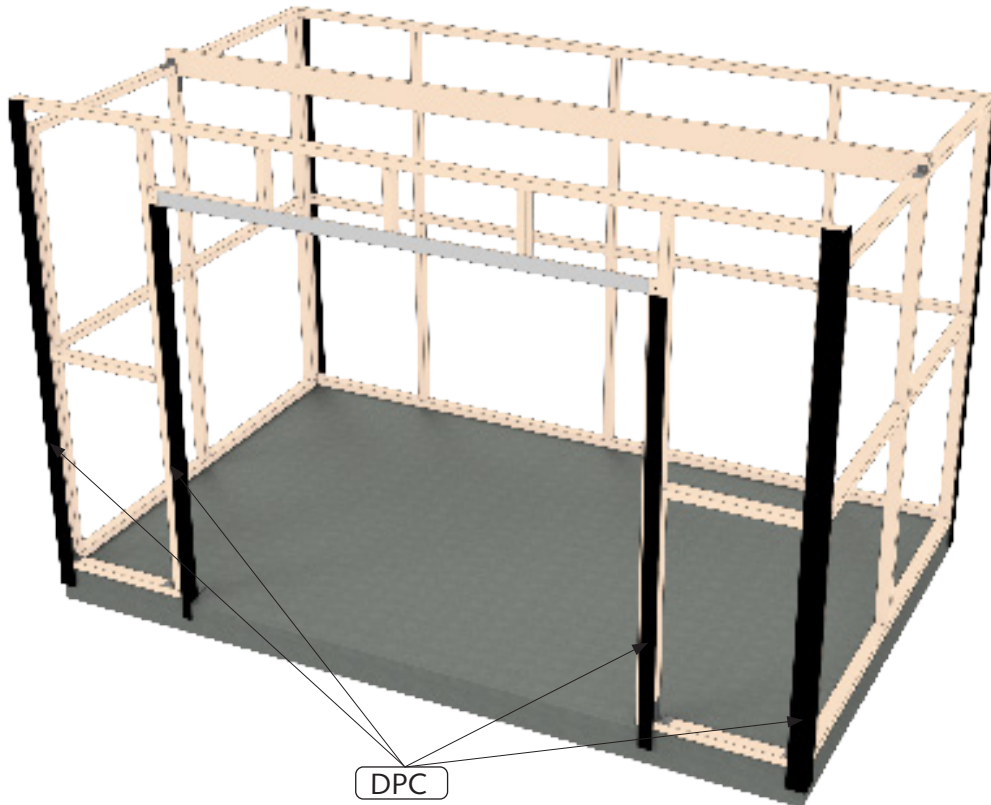

- If fitting optional building paper to walls, staple building paper to outside of frame and proceed with wall claddings. Once the cladding is complete, remove timber bracing.

## 2. Cladding attachment

**External edges:** use Hex head Tek Screws through every 2<sup>nd</sup> trough.

**Internal edges:** use 2 Hex head Tek Screws per sheet, per stud.

**Top & bottom plate:** use Hex head Tek screws at every stud.

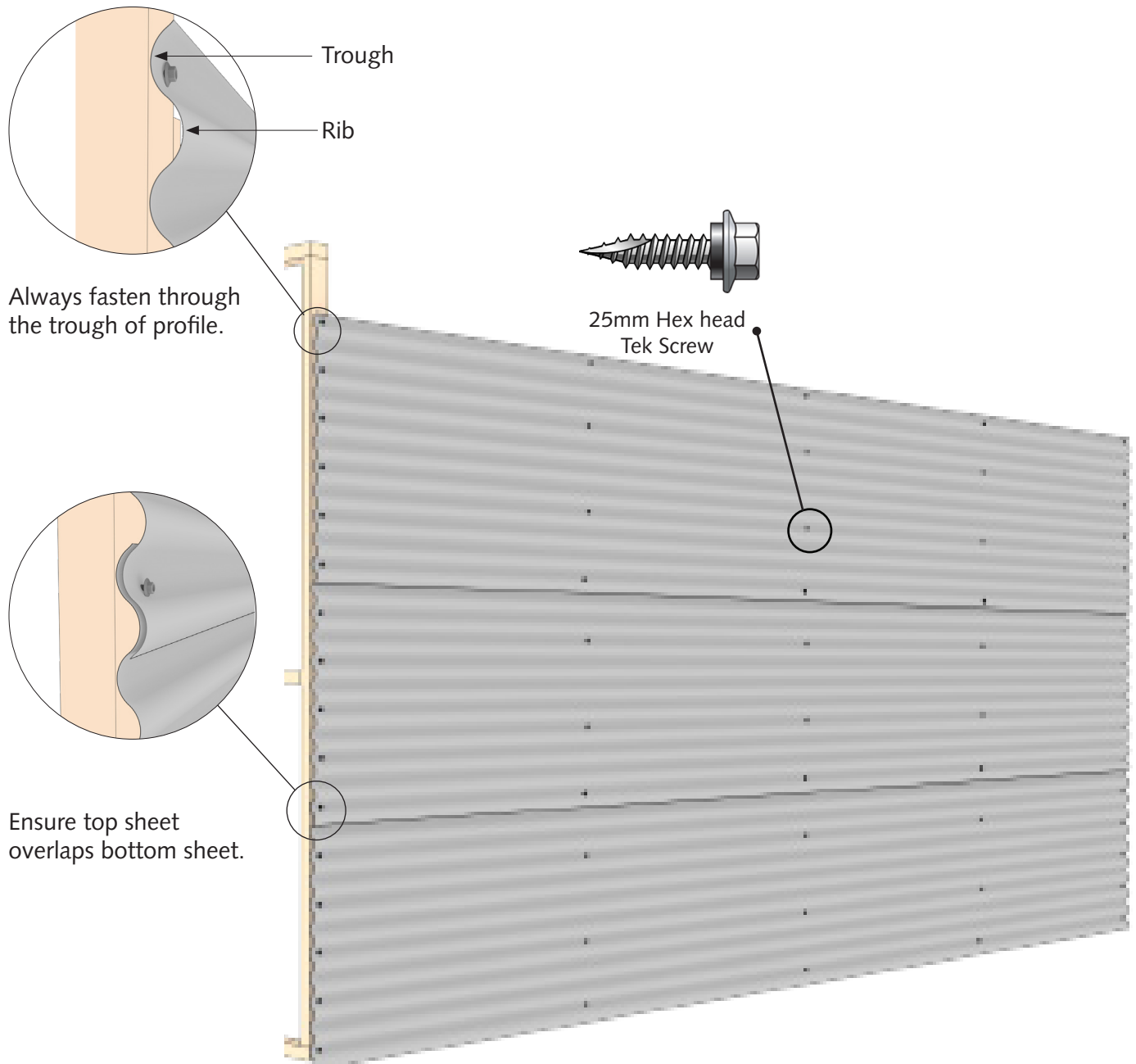

- Top sheet must be flush with the top of the top plate.
- Ends of the corrugated sheets must be flush with outside of studs.
- Ensure metal filings have been removed from between sheets, and between sheets and fasteners.
- Pre-drill cladding using 3.5mm drill bit for easy fastening.

## 2.1 Side and back walls cladding attachment

1

- Position top sheet and secure it to timber frame using two 25mm Hex head Tek Screws at the top corners (about 30mm back from end of sheet). Top of the sheet to be flush with top of top plate and both ends flush with outside of studs, ensuring bottom of sheet is approximately 850mm down from top of the top plate (TT013).
- Fasten two 25mm Hex head Tek Screws on the outer edges, 2 ribs up from the bottom of sheet ensuring end of sheet is flush with outside of studs.

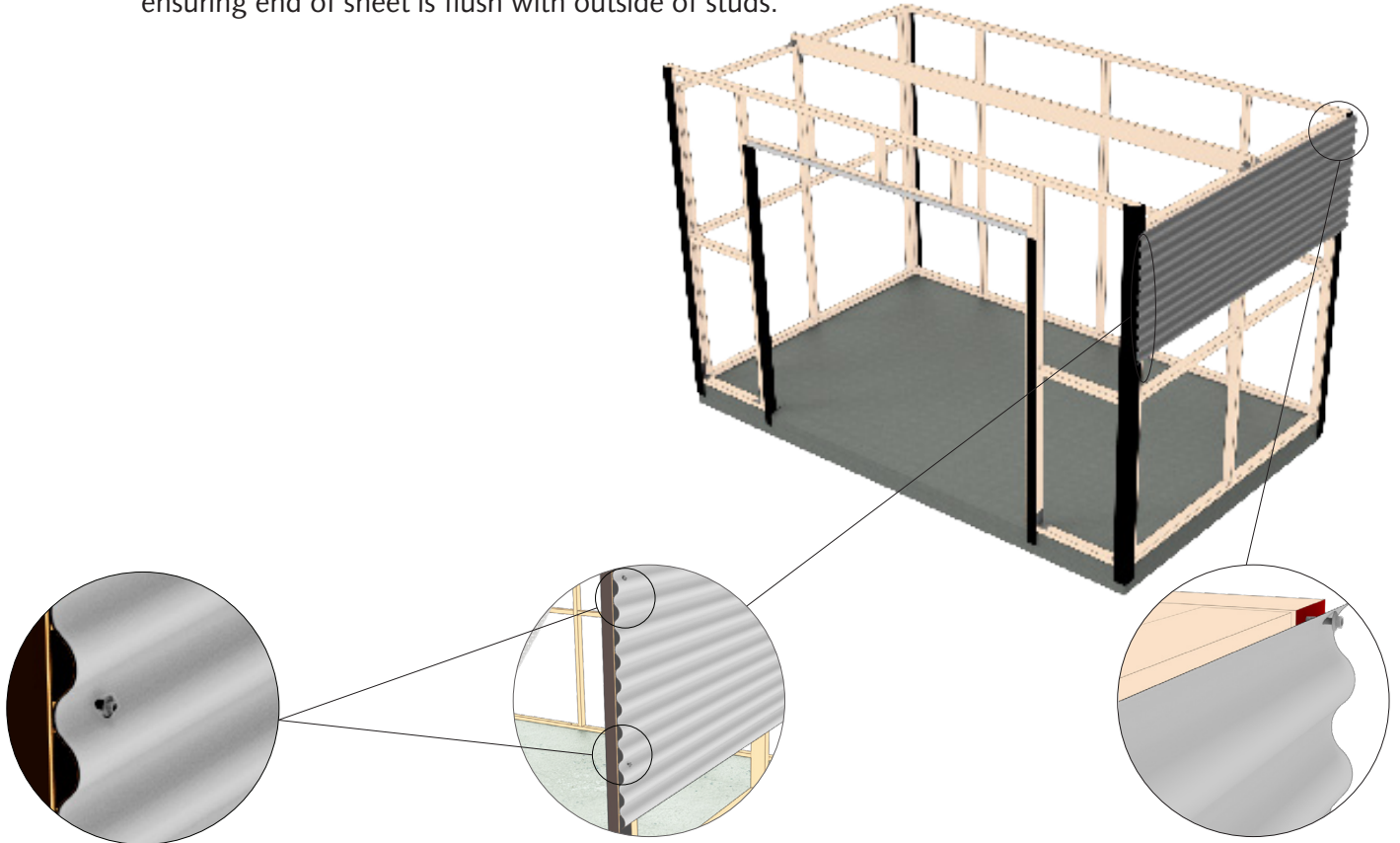

2

- Position the second sheet underneath the first sheet, ensuring top sheet overlaps the outside of the bottom sheet, and bottom of the second sheet is approximately 1607mm down from top of the top plate.
- Attach the sheet to timber frame using two 25mm Hex head Tek Screws at the top corners, through the top sheet, where it overlaps the second sheet.
- Fasten two 25mm Hex head Tek Screws 2 ribs up from the bottom of the second sheet ensuring end of sheet is flush with outside of studs.

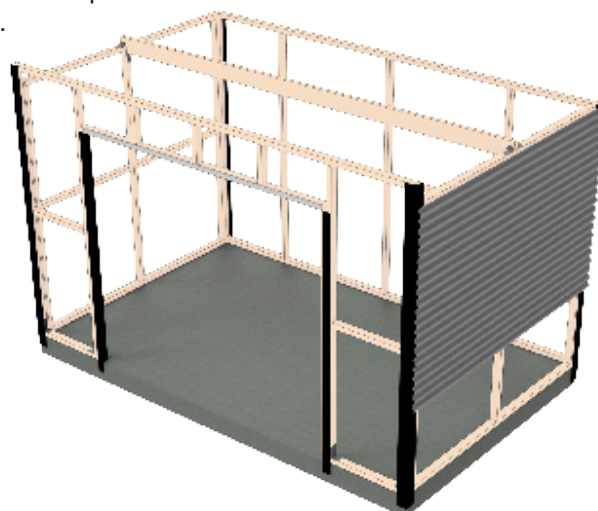

**3** Position and attach third sheet.

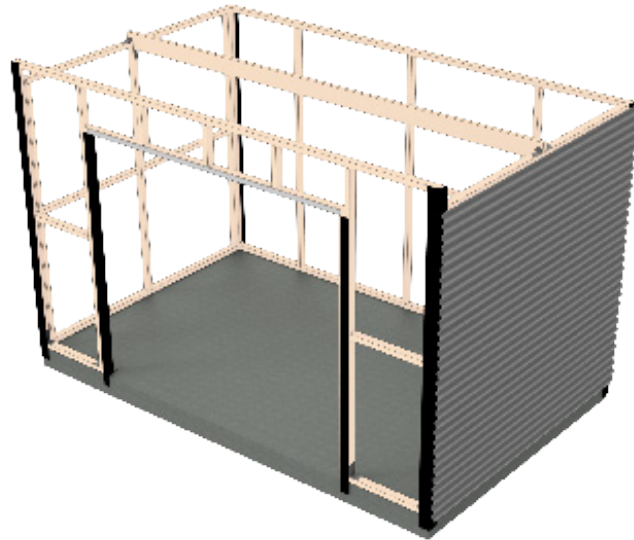

**4** Repeat these steps for remaining back and side walls sheets.

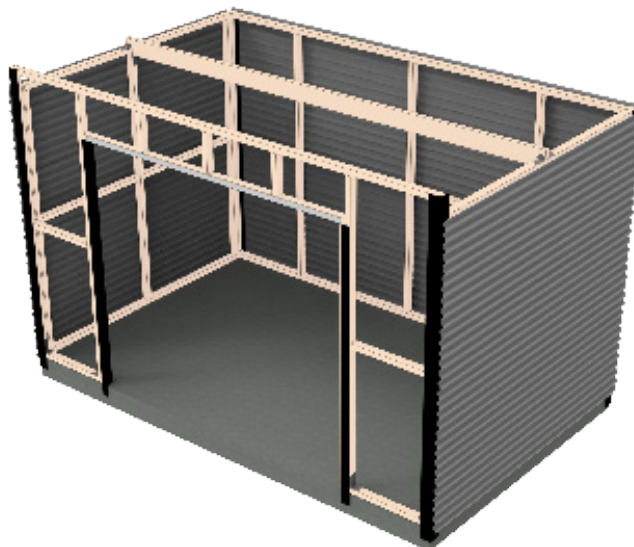

**5** Screw the 3 sheets of back and side walls using 25mm Hex head Tek Screws in the middle of each sheet (5 screws per end of each sheet and 2 in the middle).

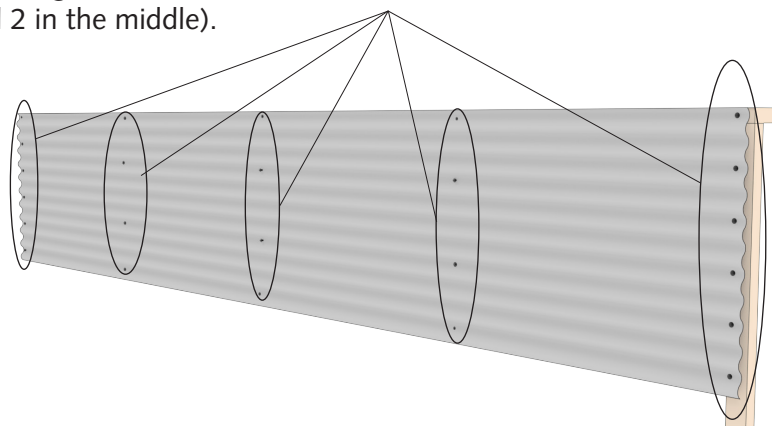

## 2.2 Front wall cladding attachment

- Position and attach sheets (as shown in the following steps) to the front wall frame, using three 25mm Hex head Tek Screws at each end. The top sheet is a half-width sheet.
- For front wall half sheet, also use 3 screws along the top plate (1 Hex head Tek Screw into each 310mm stud). Top of this sheet to be flush with top of the top plate.
- For all sheets both ends should be flush with outside of studs.

- 1**
- Ensure bottom of front wall top sheet (half sheet) is approximately 390mm down from top of front top plate.
  - Attach two back flashings (RSBF001) to door studs (TS038) on each side of doorway using three 30mm clouts per flashing. Ensure flashings are hard up underneath front wall half sheet and flush with inside of door stud.

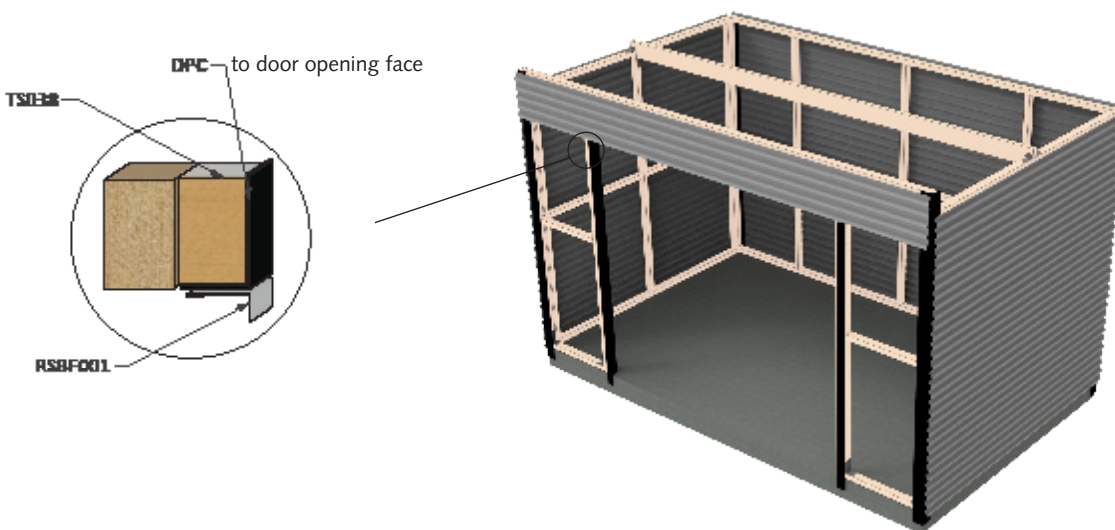

- 2**
- Ensure bottom of second row of front wall sheets is approximately 1150mm down from top of front top plate.
  - Insert top flashing (FDF004) underneath front wall half sheet, centrally over doorway. Rivet to wall sheet using 5 rivets, spaced evenly along the bottom of the top sheet.

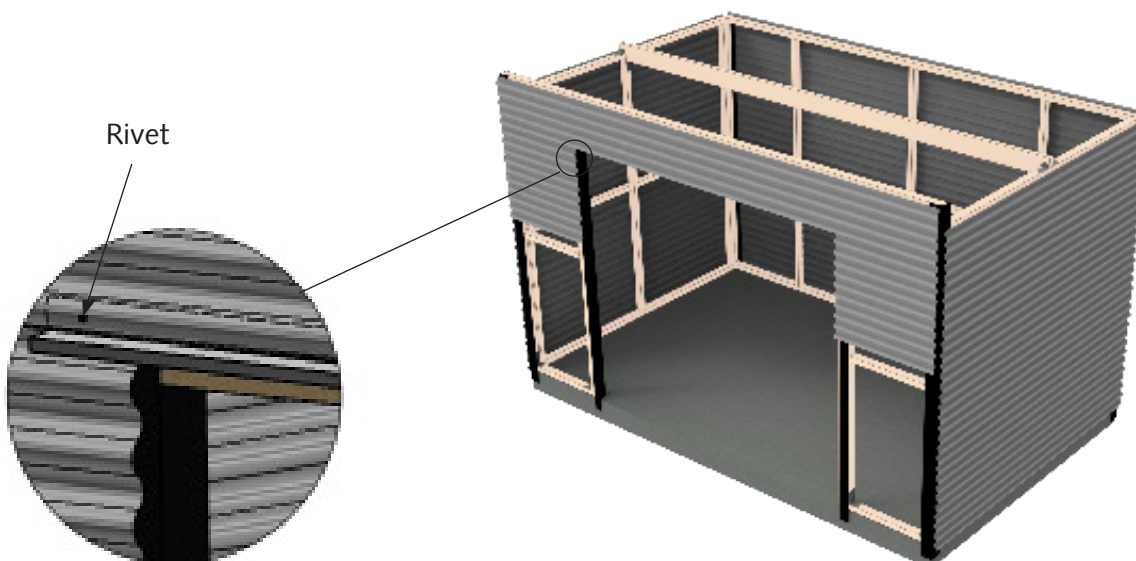

•Regarding Part IDs refer to the Parts list in pages 4 & 5.



- 3** Ensure bottom of third row of front wall sheets is approximately 1836mm down from top of front top plate.

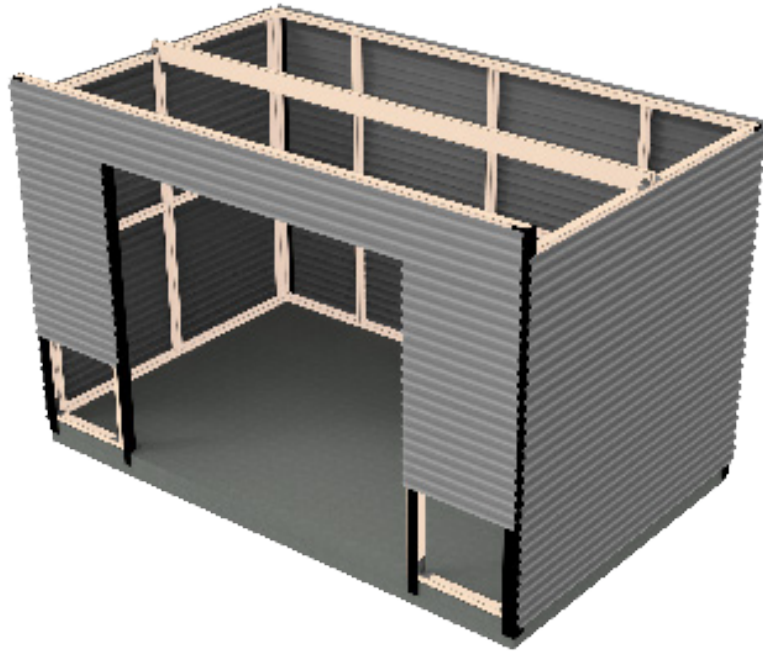

- 4** Attach fourth row of front wall sheets. Bottom of fourth row of sheet should be approximately 30mm below the base of the bottom plate. Screw off all sheets as per the diagram in section 2. **Cladding Attachment.**

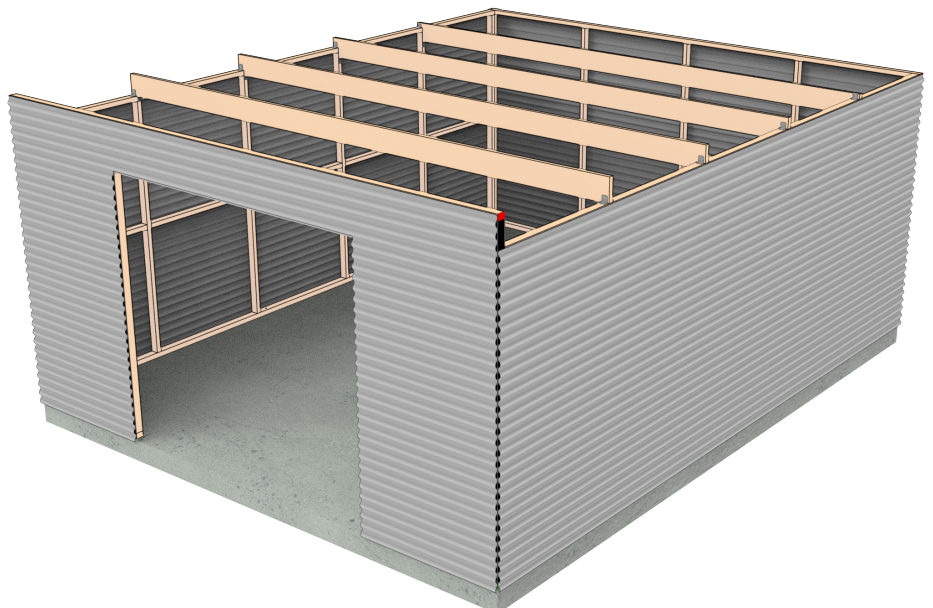

## 3. Flashing attachment

### 3.1 Top plate and door flashing attachment

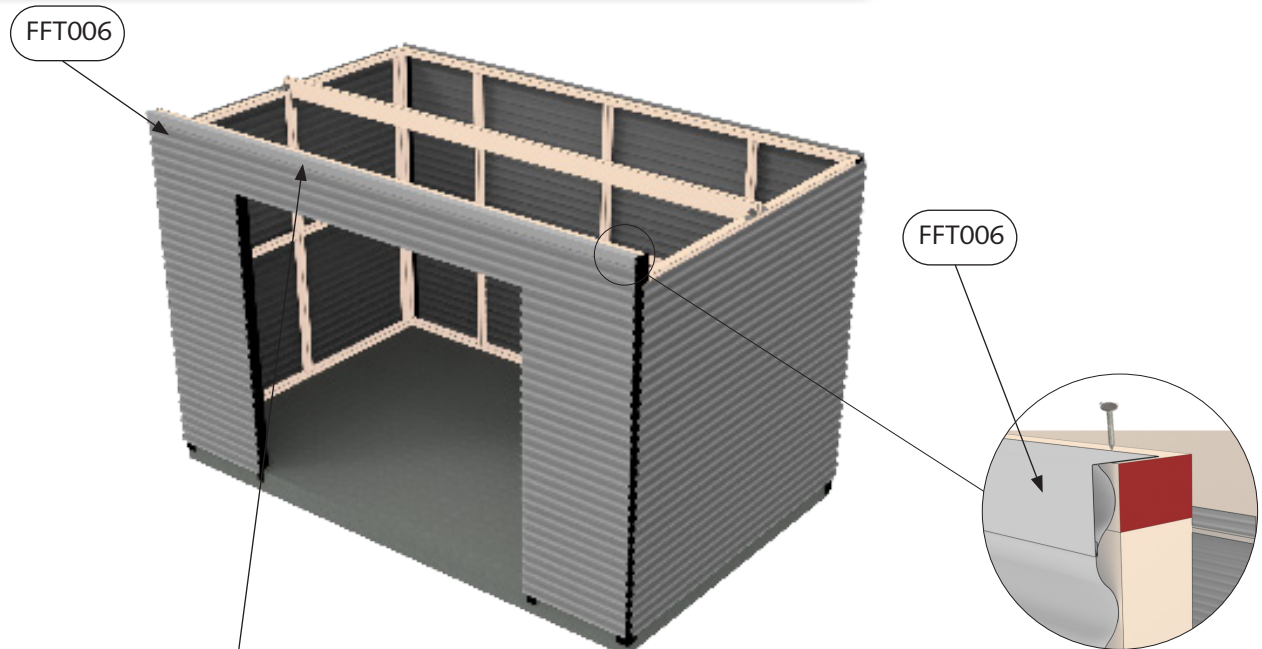

- 1** Centralise front top plate flashing (FFT006) and attach with four 30mm clouts to top plate.
- 2**
  - Position door jamb flashing (FDJ003), so top is tight against underside of top flashing (FDF004).
  - Notch bottom of flashing around base and the lintel using tin snips.
  - Nail door jamb flashing to inside of stud using three 30mm clouts and screw it into stud through the front of wall cladding using three 55mm Hex head Tek Screws near outer edge of flashing, where it passes over a crest on the cladding .

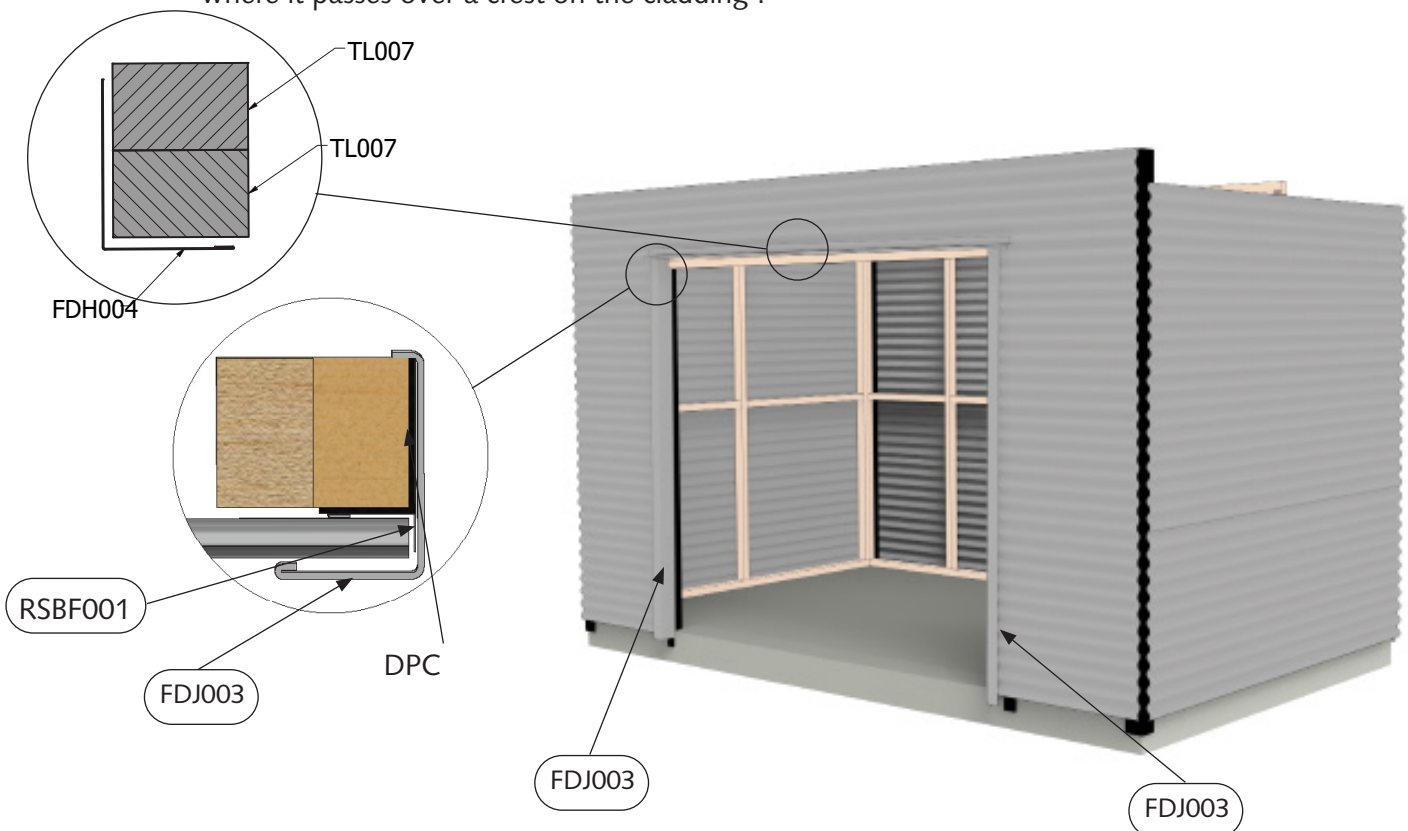

•Regarding Part IDs refer to the Parts list in pages 4 & 5.



## 3.2 Corner flashings attachment

- Attach corner flashings onto corners using six 55mm Hex head Tek Screws per corner, starting approximately 250mm down from top of the top plate, near the outer edge of the corner flashing where it passes over a crest in the cladding.
- Ensure corner flashings are square and parallel with wall panels.
- Ensure bottom of flashings are level with bottom of cladding.
- Ensure all swarf is removed from surface of cladding.



## 3.3 Spouting assembly

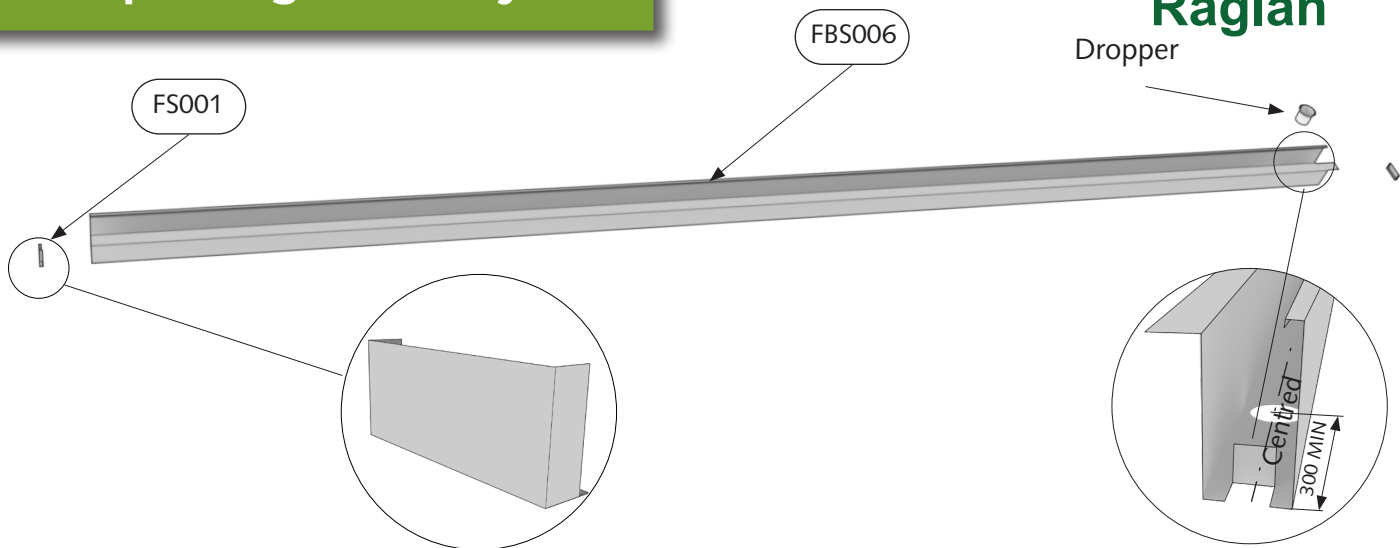

**1**

- Position dropper anywhere on the spouting (at least 300mm from either end, centred front and back) and mark diameter of dropper.
- Drill a small hole, and using tin snips, cut a larger hole (slightly larger than the diameter of dropper).

**2**

- Silicone around the hole and insert dropper into hole.
- Screw sleeve onto dropper from underneath.

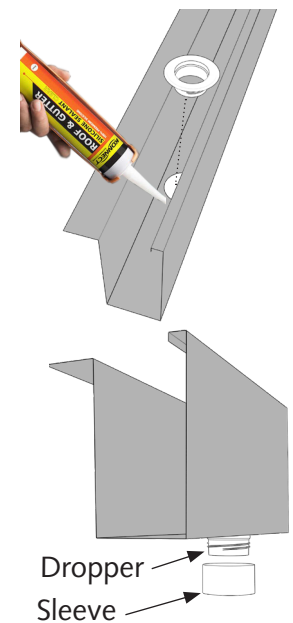

**3**

- Using tin snips cut two 50mm snips in each end of spouting as shown.
- Bend tab between snips upwards until it is 90° to base of spouting.

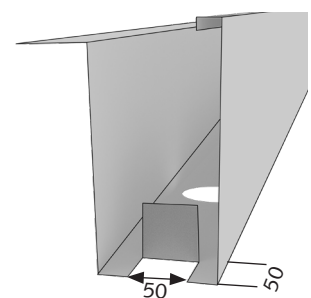

**4**

- Fit and rivet end caps behind tab to each end using 4 rivets per end.
- Silicone both end caps to spouting to ensure there is no leak.

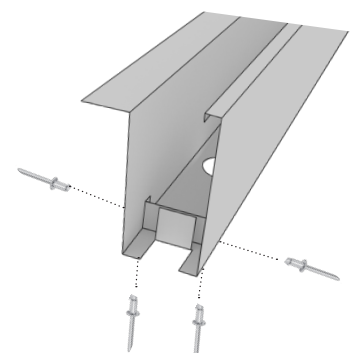

## 3.4 Spouting attachment

- 1** Centralise and nail the assembled spouting to top of the back top plate using four 30mm clouts, so spouting overhangs corner flashings by approximately 25mm at each end.

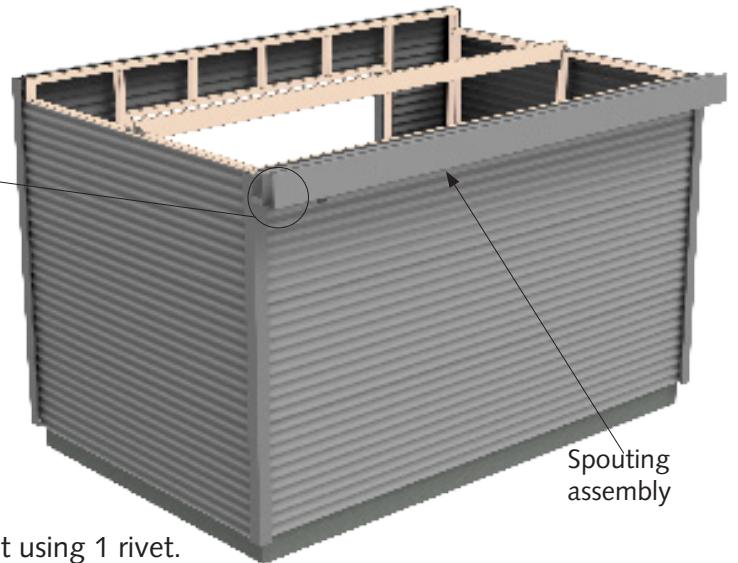
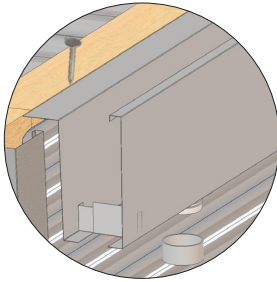

- 2**
- Cut downpipe to desired length.
  - Insert downpipe into dropper, and fasten it using 1 rivet.
  - Fix downpipe to the back wall cladding using 2 downpipe brackets, equally-spaced, riveting them into back wall cladding.

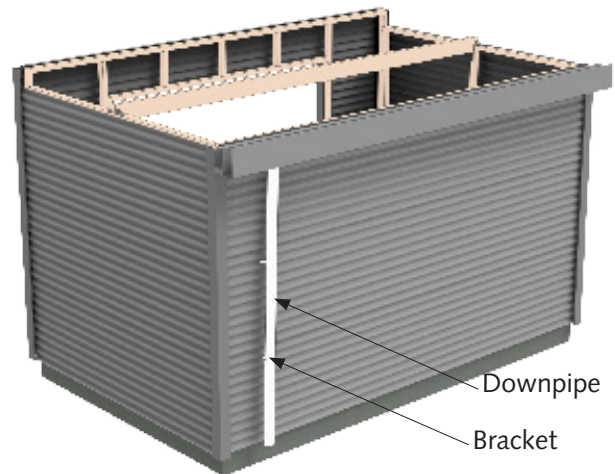

- 3** Using 6 rivets equally-spaced attach downpipe flashing to wall cladding.

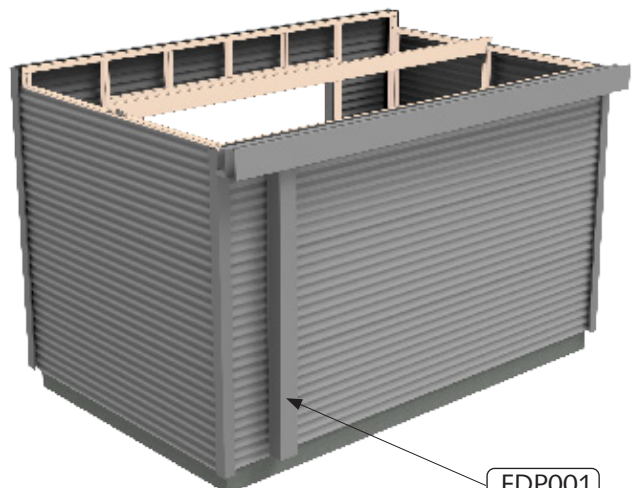

•Regarding Part IDs refer to the Parts list in pages 4 & 5.

## 4. Roof sheets attachment

### 4.1 Layout for fastening roof sheets

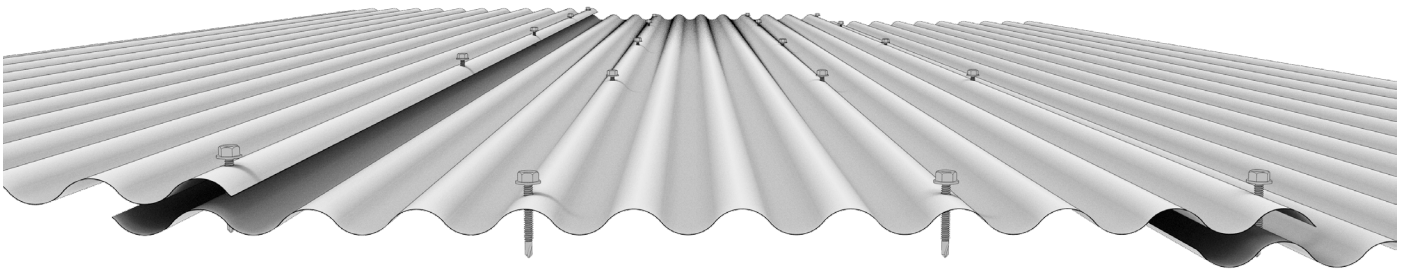

- Use 55mm Hex head Tek Screws to fasten roof sheets.
- Always fasten through top of rib of profile.
- Use 4 Hex head Tek Screws per sheet / top plate / ridge beam.

### 4.2 Optional clear roof sheet attachment

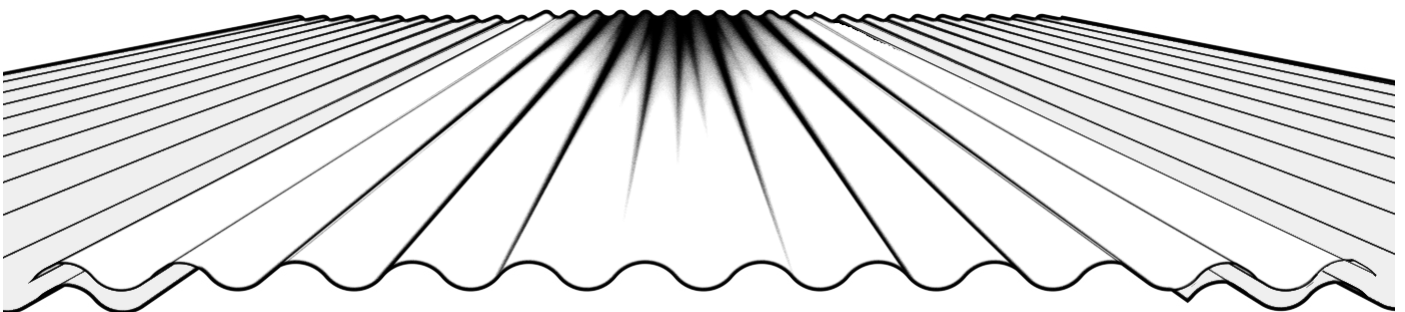

- An optional clear roof sheet (if supplied) needs to be fitted so both edges of the clear roof sheet overlap standard sheets on either side.
- For fastening clear sheet, follow the screw pattern of standard roof sheets.
- On clear sheet use dome washers under the screw heads.

## 4.3 Roof sheets fastening



- Each sheet must correctly overlap the previous sheet.
- Sheets must be 480mm past front top plate flashing (FFT006) and overlap back spouting.
- After fastening all roof sheets, ensure metal filings have been removed from sheet surfaces and between sheets, and between sheets and fasteners.

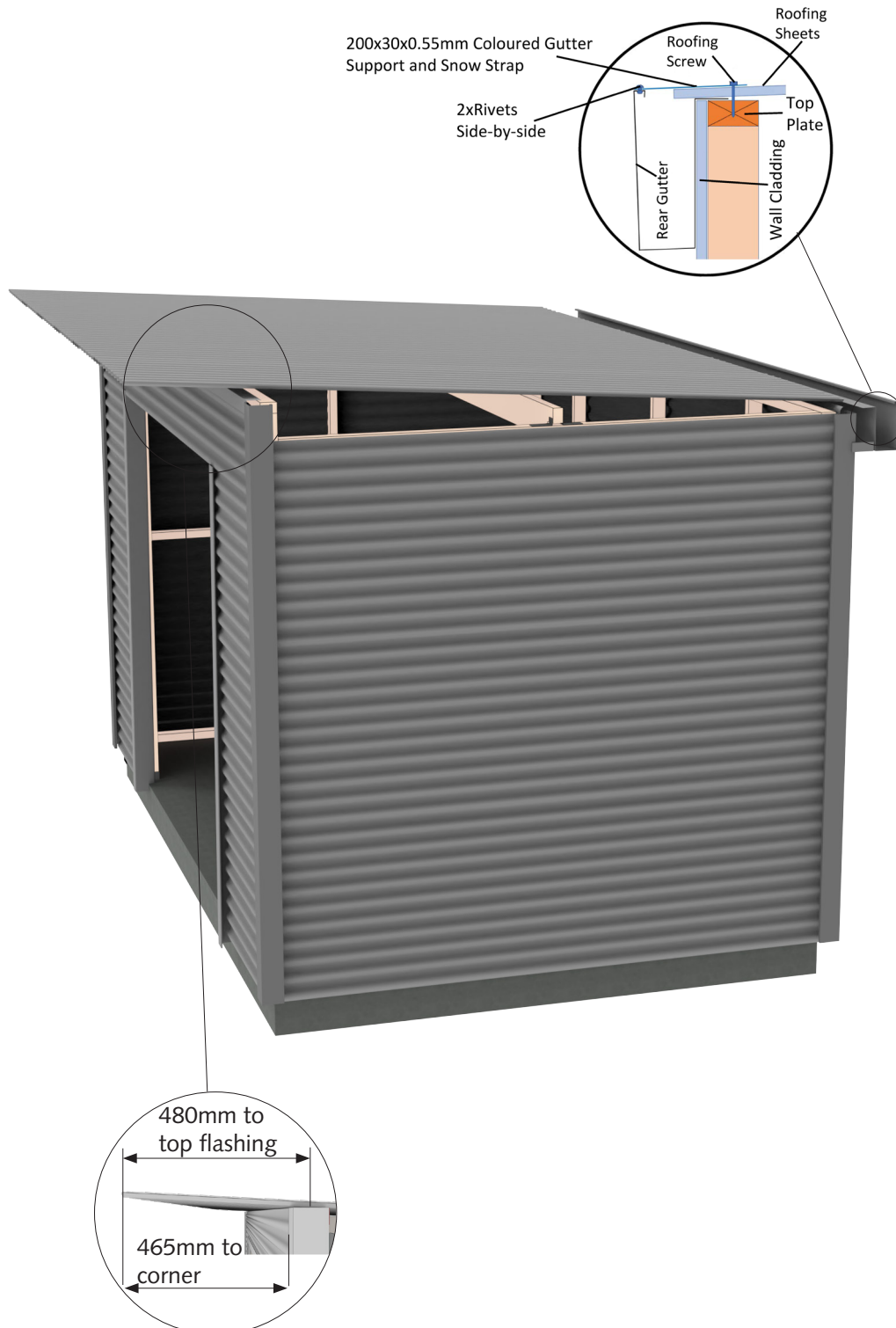

1

Ensure top plate and ridge beams are straight before attaching roof sheets.



You may temporarily brace top plates and ridge beams to ensure they are straight, by nailing timber from packaging crate, as shown. Nail to underside if you are using building paper or netting.

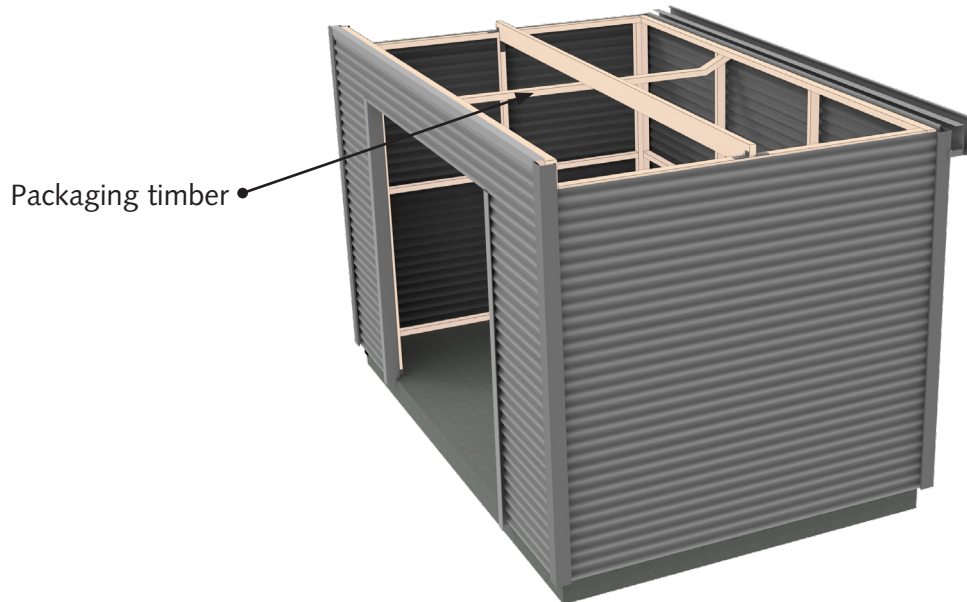

Condensation can form on underside of the shed roof. If building paper is required, fit it now. Building paper will need to be supported by netting.

2

Position first roof sheet ensuring right edge of sheet is set back from end of ridge beam by approximately 5mm, and correct front overhang of distance of 480mm from top flashing.

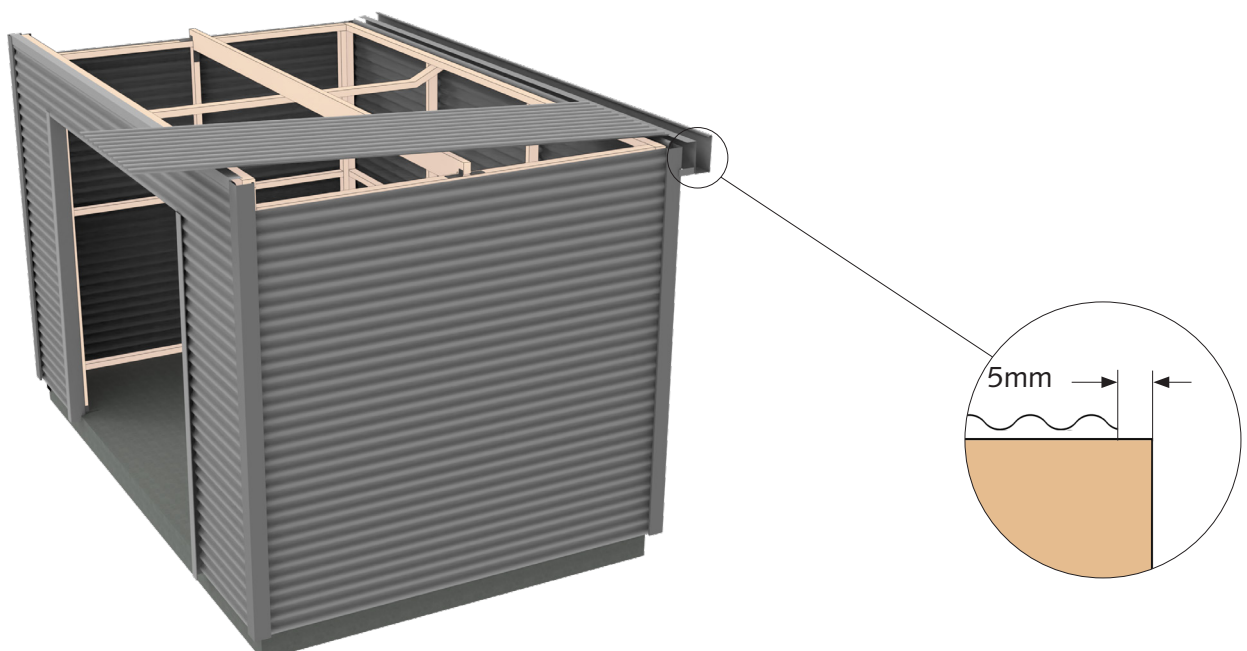



**3**

Position second and third roof sheets ensuring edge of each sheet is approximately 762mm from edge of previous sheet.

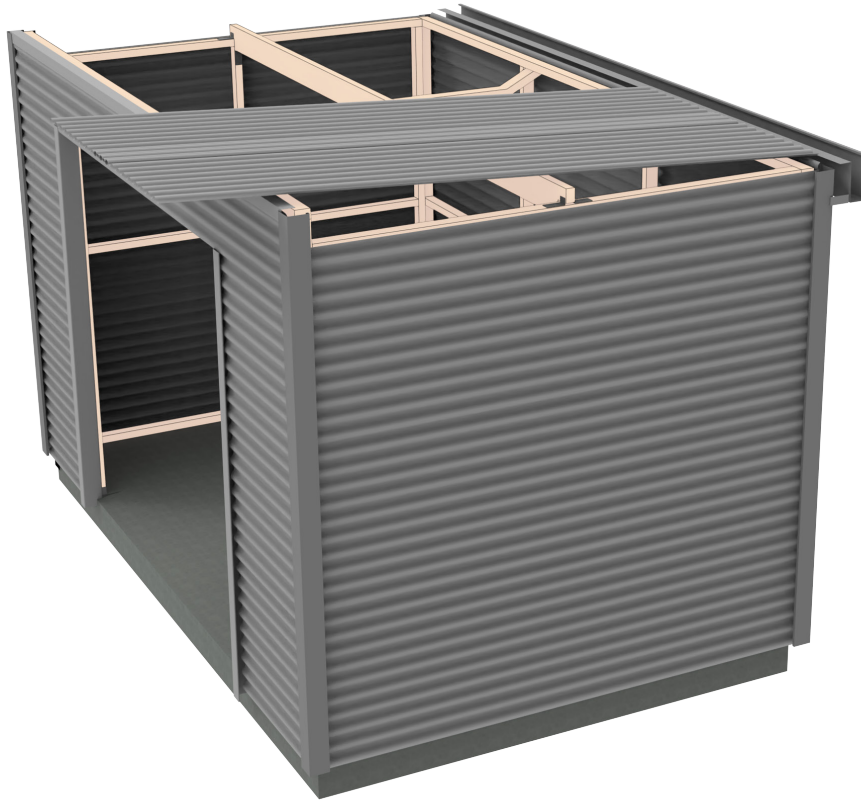

**4**

- Position remaining roof sheets ensuring correct front overhang.
- Position last sheet to ensure it is within 10mm from end of ridge beams.
- Remove bracing timber, after roof is attached.

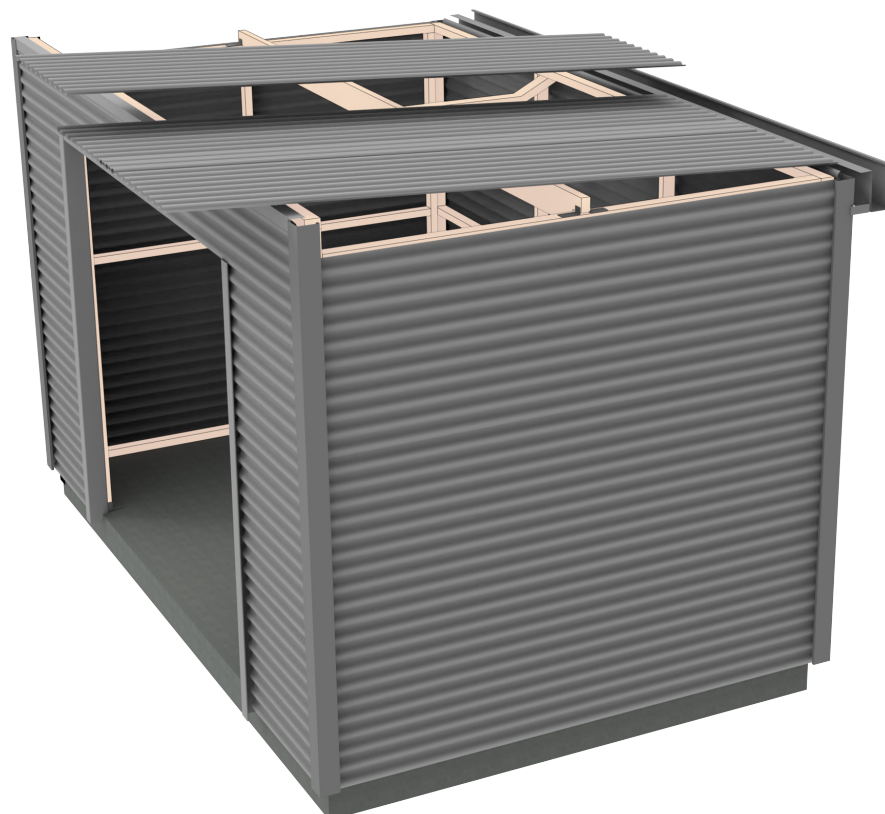



## 5. Fascia and barge attachment

### 5.1 Barge flashings and fascia attachment

- 1 • Using three 55mm Hex head Tek Screws equally spaced per barge, secure barge flashings through roof sheets into the end of ridge beams and top plates.

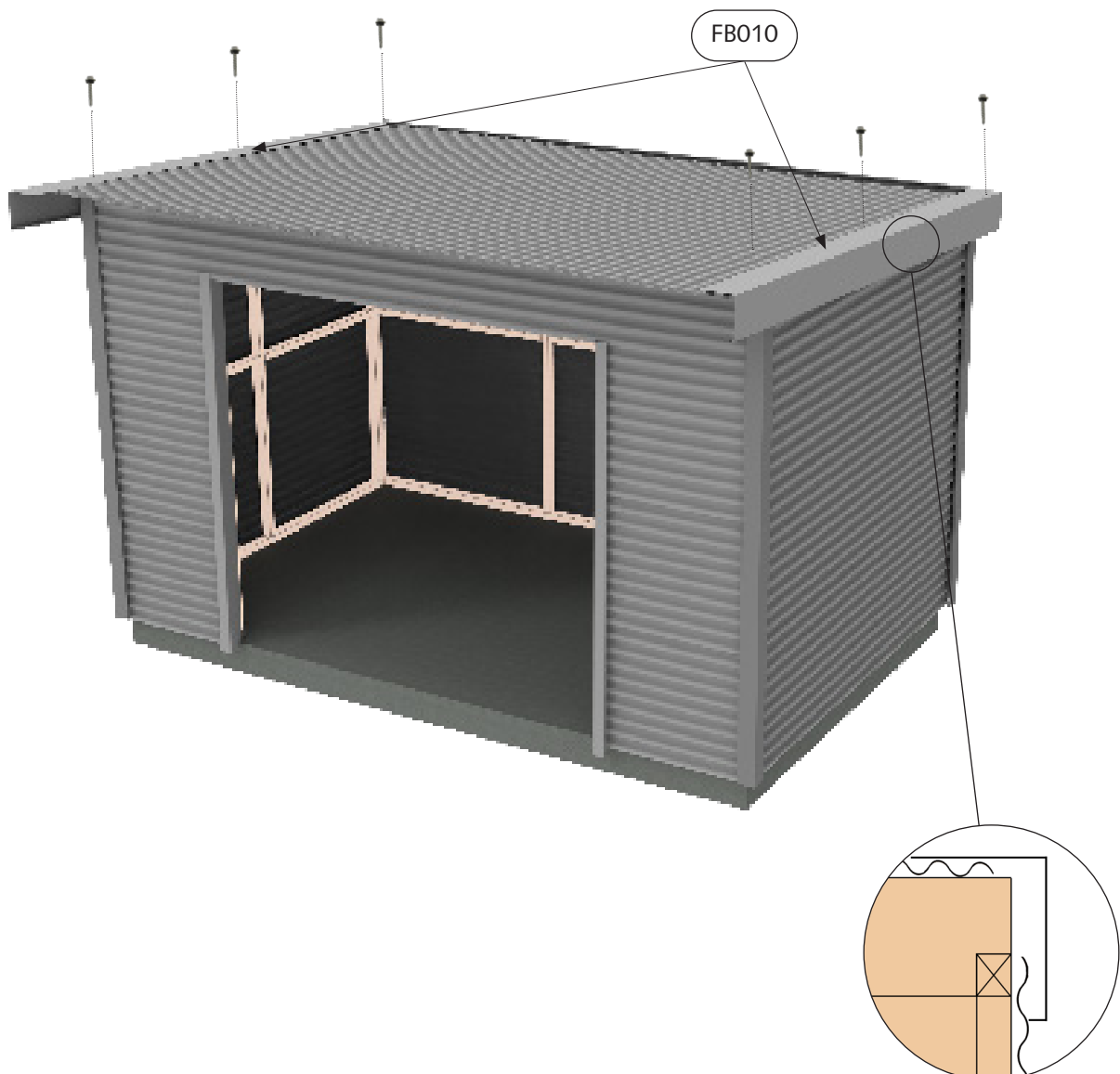

•Regarding Part IDs refer to the Parts list in pages 4 & 5.

- 2** Install fascia and rivet its ends to barge flashings at both top and bottom. Fasten top of to the roof sheeting, 1 Hex head Tek Screw in the centre of each sheet. Then, fasten the underneath of fascia to the underside of the roof sheets using rivets, equally spaced, 3 rivets per sheet.

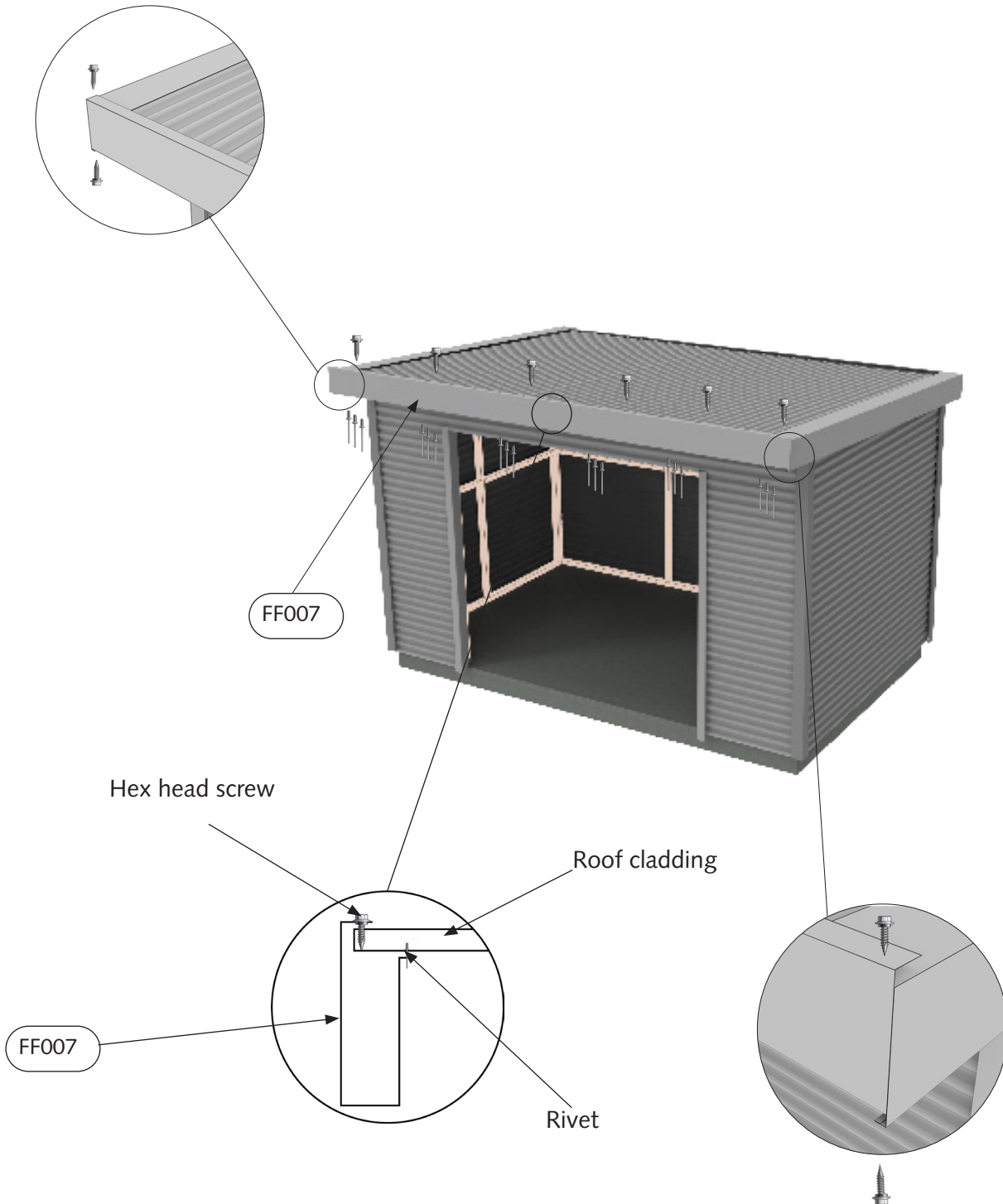

## 6. Ranch slider attachment

Place continuous bead of sealant on slab, full width of where the ranchslider is to sit. Insert ranchslider, lifting the top against the lintel, then lowering onto the silicon bead. Push the ranchslider within the opening so that the gap to the framing on either side is equal (about 5mm). There should be a gap of approximately 10mm between the top of the ranchslider and the lintel. Push the ranchslider so that the rim is hard against the door jamb flashing. Secure the ranchslider frame to the side with 3x50mm screws each side. Secure ranchslider frame to the lintel with 3x50mm screws. Screws pass through the centre of the liner.

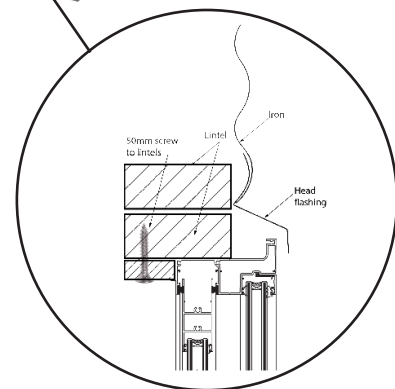
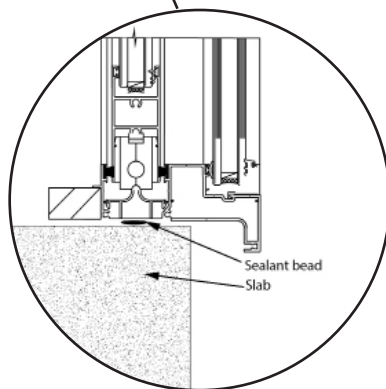
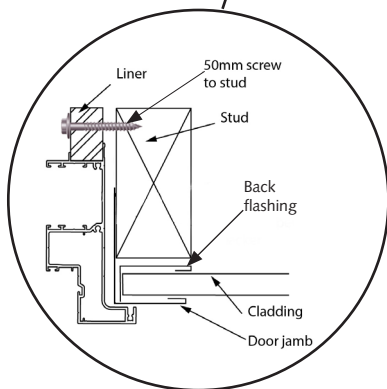
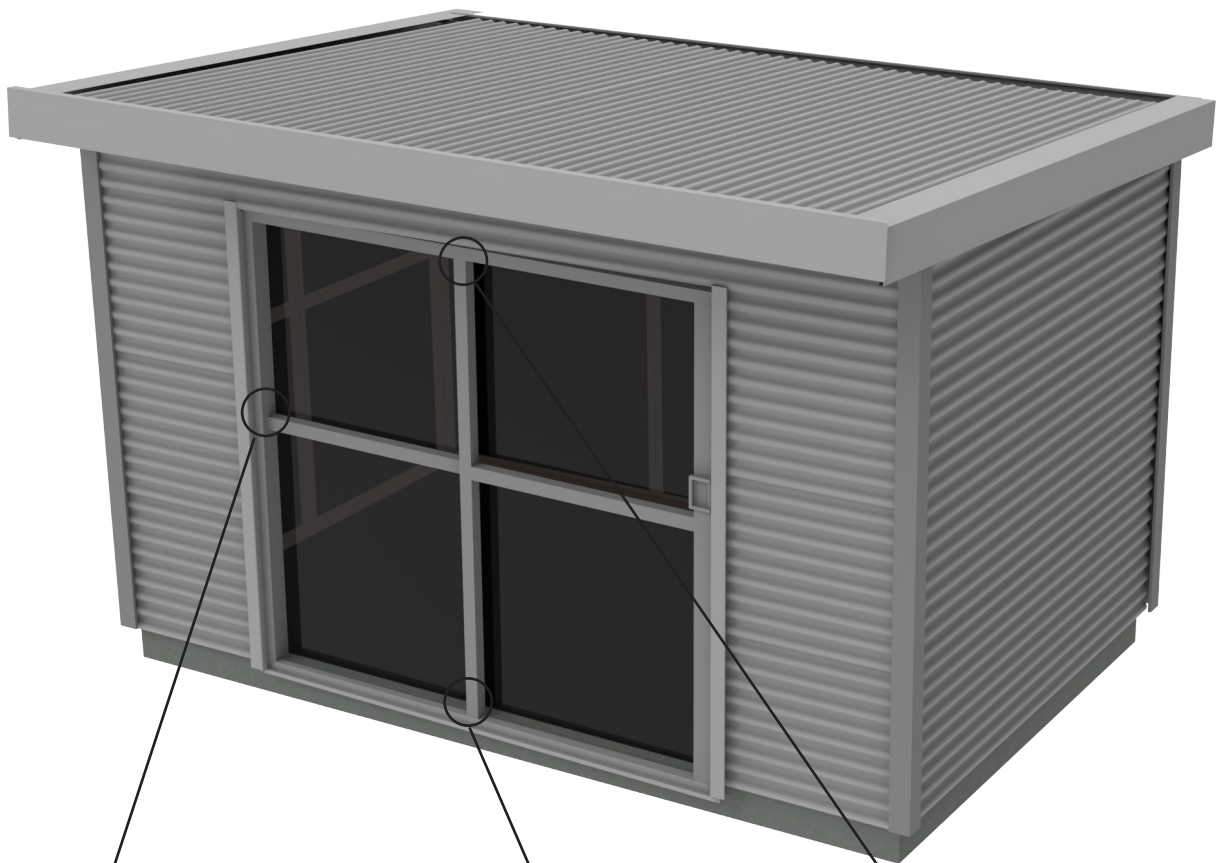

## Duratuf Lifestyle shed Triple Warranty

1. Duratuf warrants that their Lifestyle sheds will be free from manufacturing defects for **30 years**. This warranty also covers components which are missing or damaged at time of despatch from the factory.
2. Duratuf warrants the durability of the structural framing for **30 years**.
3. Duratuf warrants that the metal roofing and wall cladding will not perforate due to corrosion within the following periods:
  - Standard Non-Coastal Warranty – **30 years** if located greater than 2,000m from saltwater, or **15 years** if located between 1,000m and 2,000m from saltwater.
  - With Coastal Upgrade Option – **30 years** if located greater than 1,000m from saltwater, or **15 years** if located between 250m and 1,000m from saltwater.

### WARRANTY TERMS AND CONDITIONS

- The warranty is not transferrable and only valid for the original purchaser. Proof of purchase and proof of damage or defect is required to submit a claim. Warranty periods begin at the date of manufacture.
- This warranty is in addition to your rights under New Zealand consumer law and must be registered within 90 days from purchase to be valid. Refer to the warranty registration guidance below. All claims must be made in writing within 30 days of discovery. Interference with the product or other action taken to remedy a defect prior to Duratuf being notified of the suspected defect and Duratuf being given a reasonable time to inspect the product in situ will invalidate a claim.
- For the warranty to be valid, the recommendations in our **Kitset Care Guide** <https://www.duratuf.co.nz/kitset-care-guide/> and the **Assembly Care Instructions** given in the Assembly Instruction booklet must be followed; and the **Minimum Maintenance** in accordance with instructions below must be performed for the life of the product.
- Except as provided otherwise by NZ consumer law, the liability of Duratuf is limited to replacing or repairing any defective or missing product. Any repaired or replaced material will be covered only by the balance of the original warranty period. Duratuf will not be liable for any consequential loss or damage, or labour costs. Transport charges will apply to our nearest reseller only.
- The structural framing and cladding warranties are subject to the shed being installed on a level concrete base, or other solid supports, at least 40mm above ground level, and contact being prevented at all times with soil, vegetation, organic matter, fertilizers, or other moisture retaining substances.
- In the rare event of a claim and upon receiving proof of purchase and defect, Duratuf will at its option repair or replace defective parts, or provide a prorated refund for the remaining life of the applicable warranty. Any replacement product provided will be covered by the Warranty for the balance of the Warranty term as if the replaced product were the original product.
- Duratuf reserves the right to inspect the shed in situ at the installation site and to conduct tests at any time after a Warranty claim is received. Any interference with the shed prior to inspection by Duratuf may void a claim under this Warranty.
- Any product replaced under this Warranty becomes the property of Duratuf.
- Any failure, delay, or indulgence by Duratuf will not operate as a waiver. A waiver by Duratuf of any condition of this Warranty is not a waiver of any other condition. No waiver is effective unless it is in writing.
- All terms, conditions, warranties, undertakings, inducements, and representations other than contained in this warranty, whether express or implied, statutory, or otherwise, are expressly excluded.
- This Warranty does not exclude, restrict, or modify any liability that cannot be excluded, restricted, or modified at law.

### EXCLUSIONS FROM WARRANTY COVER

- Normal wear and tear. Fading, chalking, or discolouration of the cladding. Minor white corrosion at cuts or bends.
- Cladding perforation in areas where severe or very severe environmental situations are extended inland by local conditions.
- Timber floors less than 40mm above ground level, or where used for storage of other than normal lightweight household items.
- This warranty will not apply if the failure or defect is caused or contributed to by an event or action beyond the reasonable control of Duratuf, including without limitation:
  - Mechanical, chemical, or other damage sustained after despatch from Duratuf's factory.
  - Problems resulting from misuse or use for purposes other than normal dry storage use.
  - Fire, flood, storm, cyclone, earthquake or other 'Acts of God.'

### MINIMUM MAINTENANCE REQUIREMENTS

- All metal swarf must be cleaned off the shed IMMEDIATELY.
- Wash all external surfaces using a soft nylon brush with water every 12 months, or for locations within 2 km of saltwater, wash every 3 months. After a storm, wash the cladding and the gutters as soon as possible to remove any salt deposits.
- A low-pressure water spray may also be used, less than 10 MPa (1500 psi or 100 Bar).
- Outdoor cleaning detergents may be used if they do not contain bleach, chlorine, or other harmful chemicals.
- Volcanic ash fallout and pollen deposits—wash as soon as possible, removing all deposits from roof and gutters.
- Gutters and channels to be kept clear of leaves and dirt at all times.
- Remove any lichen or mould: First wash off any loose growth with a brush and water. Apply diluted bleach (sodium hypochlorite) at 2% solution. A small amount of household detergent (no more than 5-7 ml per litre of water) may be added to the solution to improve wetting. Leave for 5 minutes. Wash down with copious amounts of clean water.
- Remove and replace any fasteners, washers, or fittings showing signs of corrosion.

## Warranty registration

Go to <https://duratuf.co.nz/warranty> to register the Warranty within 90 days of purchase. Alternatively, call us on 0800 438 274. It is important to keep your proof of purchase as it will be required in the unlikely event of a claim. Many thanks, from the team at Duratuf.



**Thank you for investing in a Duratuf Lifestyle Range Shed.**

