

# BUILDING PERFORMANCE

# Building work that does not require a building consent

## Exemptions Guidance for Schedule 1 of the Building Act 2004

Fifth edition - August 2020  
First published - March 2014



# Ministry of Business, Innovation and Employment (MBIE)

## Hīkina Whakatutuki - Lifting to make successful

---

MBIE develops and delivers policy, services, advice and regulation to support economic growth and the prosperity and wellbeing of New Zealanders.

The Exemptions Guidance document is produced by the Building System Performance branch.

This document is issued as guidance under section 175 of the Building Act 2004. While MBIE has taken care in preparing the document it should not be relied upon as establishing compliance with all relevant clauses of the Building Act 2004 or Building Code in all cases that may arise. This document may be updated from time to time and the latest version is available from MBIE's website at [www.building.govt.nz](http://www.building.govt.nz).

---

### More information

[www.building.govt.nz](http://www.building.govt.nz)  
[0800 24 22 43](tel:0800242243)

Information, examples and answers to your questions about the topics covered here can be found on our website [www.building.govt.nz](http://www.building.govt.nz) or by calling us free on [0800 24 22 43](tel:0800242243).

---

### Fifth edition - August 2020

First published March 2014

Amended August 2020

ISBN 978-1-99-001940-1 (online)

---

### ©Crown Copyright

The material contained in this document is subject to Crown copyright protection unless otherwise indicated. The Crown copyright protected material may be reproduced free of charge in any format or media without requiring specific permission. This is subject to the material being reproduced accurately and not being used in a derogatory manner or in a misleading context. Where the material is being published or issued to others, the source and copyright status should be acknowledged. The permission to reproduce Crown copyright protected material does not extend to any material in this report that is identified as being the copyright of a third party. Authorisation to reproduce such material should be obtained from the copyright holders.

# Contents

---

Purpose	8
Who is this guidance for	8
How to use this guidance	8
Some work is exempt	9
Ask for advice	10
Who can undertake exempt work	11
Before you start	12
Amendments to building consent exemptions	13
Territorial and regional authority discretionary exemptions	14
<b>1. General alterations, maintenance and removal</b>	<b>21</b>
1.1. General repair, maintenance, and replacement of building parts	22
1.2. Interior alterations to existing non-residential building	26
1.3. Penetrations through building components	29
1.4. Removal of building element	32
1.5. Removal of structures	34

<b>2. Detached, standalone buildings</b>	<b>37</b>
<hr/>	
Notes for single-storey detached buildings: 2.1-2.5	38
<hr/>	
2.1. Single-storey detached buildings less than 10 square metres	41
<hr/>	
2.2. Single-storey detached buildings exceeding 10, but not exceeding 30, square metres in floor area and constructed of lightweight material	44
<hr/>	
2.3. Single-storey detached buildings not exceeding 30 square metres in floor area with prefabricated or kitset components	48
<hr/>	
2.4. Single-storey detached buildings not exceeding 30 square metres in floor area	52
<hr/>	
2.5. Unoccupied detached buildings for housing fixed plants or machinery	56
<hr/>	
Notes for single-storey pole sheds and hay barns in rural zones: 2.6-2.7	58
<hr/>	
2.6. Single-storey pole sheds and hay barns	60
<hr/>	
2.7. Single-storey pole sheds and hay barns in rural zones	63
<hr/>	
2.8. Repair or replacement of outbuilding	67
<hr/>	
2.9. Demolition of detached building	70
<hr/>	
<b>3. Windows, doors and walls</b>	<b>73</b>
<hr/>	
3.1. Windows and exterior doorways in existing dwellings and outbuildings	74
<hr/>	
3.2. Alteration to entrance or internal doorway to facilitate access for persons with disabilities	77
<hr/>	
3.3. Internal walls and doorways in existing building	79
<hr/>	
3.4. Internal linings and finishes in existing dwelling	82
<hr/>	

<b>4. Plumbing and drainage</b>	<b>85</b>
4.1. Repair, maintenance, and replacement of sanitary plumbing and drainage	86
4.2. Drainage access points	88
4.3. Repair and maintenance of existing water heater	90
4.4. Replacement of open-vented water storage heater connected to supplementary heat exchanger	92
4.5. Replacement or repositioning of water heater connected to controlled heat source	94
4.6. Minor alteration to drains	97
4.7. Alteration to existing sanitary plumbing (excluding water heaters)	99
<b>5. Insulation and moisture barriers</b>	<b>103</b>
5.1. Thermal insulation	104
5.2. Ground moisture barrier	106
<b>6. Porches, verandas and pergolas</b>	<b>109</b>
Notes for porches and verandas	110
6.1. Porches and verandas up to 20 square metres	111
6.2. Porches and verandas exceeding 20 square metres in floor area but not exceeding 30 square metres	113
6.3. Porches and verandas exceeding 20 square metres in floor area but not exceeding 30 square metres	116
6.4. Closing in existing veranda or patio	120
6.5. Pergolas	122
<b>7. Platforms, decks and bridges</b>	<b>125</b>
7.1. Decks, platforms, bridges, boardwalks etc	126
7.2. Short-span bridges on private land	128

<b>8. Shelters, shades and carports</b>	<b>133</b>
Notes for carports: 8.1-8.3	134
8.1. Carports not exceeding 20 square metres in floor area	136
8.2. Carports exceeding 20 square metres in floor area, but not exceeding 40 square metres	138
8.3. Carports exceeding 20, but not exceeding 40, square metres in floor area	140
8.4. Shade sails	143
8.5. Tents, marquees, and similar lightweight structures	145
Notes for Ground floor awnings: 8.6-8.8	148
8.6. Ground floor awnings up to 20 square metres	149
8.7. Awnings exceeding 20 square metres in size, but not exceeding 30 square metres	151
8.8. Awnings exceeding 20 square metres in size, but not exceeding 30 square metres	153
<b>9. Fencing and restrictions</b>	<b>157</b>
9.1. Fences and hoardings	158
9.2. Means of restricting access to small heated pools	160
9.3. Height-restriction gantries	162
<b>10. Playground equipment</b>	<b>165</b>
10.1. Private household playground equipment	166
10.2. Certain public playground equipment	168
<b>11. Pools, tanks and dams</b>	<b>171</b>
11.1. Tanks and pools	172
11.2. Dams (excluding large dams)	174
11.3. Flexible water storage bladders	176

<b>12. Signage</b>	<b>181</b>
12.1. Signs up to 6 square metres, with 3 metre height limit	182
12.2. Signs with no restrictions on size	184
<b>13. Support structures</b>	<b>187</b>
13.1. Structures supporting water pipes	188
Notes for Retaining walls: 13.2-13.3	190
13.2. Retaining walls up to 1.5 metres depth of ground without surcharge	191
13.3. Retaining walls up to 3 metres depth of ground	194
<b>14. Other structure</b>	<b>197</b>
Notes for Ground-mounted solar panel arrays: 14.1-14.2	198
14.1. Ground-mounted solar panel arrays	200
14.2. Ground-mounted solar panel exceeding 20, but not exceeding 40, squares metres in size (outside rural zones)	203
14.3. Permanent outdoor fireplaces and ovens	205
14.4. Temporary storage stacks	207
14.5. Plinths	209
<b>15. Network utilities</b>	<b>213</b>
15.1. Certain structures owned or controlled by network utility operators or other similar organisations	214
<b>Links to earlier legislation</b>	<b>216</b>
<b>Useful links</b>	<b>217</b>
<b>Glossary</b>	<b>218</b>

# Purpose

---

This is guidance for building work that does not require a building consent under the Building Act 2004 (the Act). It lists all building work that doesn't need a building consent, with guidance to support compliance.

# Who is this guidance for

---

- **Building and home owners** who are planning building work and carry out building work themselves
- **Trade and sector professionals** who may carry out building work or provide advice
- **Councils, building consent authorities and regional or territorial authorities** who may provide advice about what does or does not need a building consent.

# How to use this guidance

---

This guidance provides information on each building consent exemption. To get started, we suggest you read the sections on:

- the context for exempt work
- seeking advice
- building owners' responsibilities
- amendments to building consent exemptions
- the relevant exemption for the work you wish to carry out.

The building consent exemptions have been grouped by building project type to help homeowners and trade sector professionals easily find the information they need to depending on the type of work they'd like to carry out. Refer to the section on [Technical requirements for exempt building work](#).

## More information:

- [Links to earlier legislation](#) ↓
- [Useful links](#) ↓
- [Glossary](#) ↓



# Some work is exempt

---

New Zealand's building legislation recognises some building work does not require a building consent. The list of building work includes conditions to manage risk.

The list of building work that does not require a building consent is provided under Schedule 1 of the Building Act 2004.

## For more information see:

- [Building Act 2004](#)
- [Section 41](#) of the Building Act 2004
- [Section 42A](#) of the Building Act 2004
- [Schedule 1, Building work for which building consent is not required](#)

The technical requirements for exempt building work section describes building work for which a building consent is not required. Detailed information and several examples are provided in this guidance. All building work, whether it needs a building consent or is exempt, must still comply with the Building Code and other relevant legislation including:

- [Plumbers, Gasfitters, and Drainlayers Act 2006](#)
- [Gas Act 1992](#)
- [Gas \(Safety and Measurement\) Regulations 2010](#)
- [Electricity Act 1992](#)
- [Electricity \(Safety\) Regulations 2010](#)
- [Resource Management Act 1991](#)
- [Fire and Emergency New Zealand Act 2017](#)
- [Health and Safety at Work Act 2015](#)
- [Local Government Act 2002](#).

## Offences and penalties

A responsible authority such as the council is able to issue a notice to fix. A notice to fix is a warning to correct an instance of non-compliance with the Building Code and/or Building Act 2004. For example, the requirement to obtain a building consent where necessary and the requirement for all building work to comply with the Building Code. If you fail to correct the non-compliance, you are liable on conviction of a maximum fine of \$200,000 and a further \$20,000 for each day the offence is continued. An instant fine of \$1,000 can also be issued if a notice to fix is not complied with.

### **Certificate of Acceptance**

You should note that exemptions are not retrospective. If you carried out unconsented building work, after 31 March 2005, which was not exempt when it was undertaken (ie it was not covered by an exemption in the legislation in force at the time), you will need to apply to the territorial authority for a certificate of acceptance.

## Ask for advice

---

As a home or building owner, you are responsible for:

- determining whether or not your building work is exempt from requiring a building consent or not
- making sure that any exempt building work complies with the Building Code and other relevant legislation.

If you are not sure whether or not your building work is exempt, it is important to get advice from a professional who has building knowledge and expertise. Even if your building work is exempt, you can still apply for a consent from your local building consent authority, if you would like extra peace of mind that your plans are compliant.

Who you can ask for advice:

- Building consent authority (typically a district or city council), as they have extensive building control expertise and planning expertise and information about exemptions and building consent processes (they may charge a fee for this)
- Registered Architect
- Chartered Professional Engineer
- Registered Building Surveyor
- Building Consultant
- Registered Electrician
- Licensed Building Practitioner – check they hold the relevant licensing class before seeking advice
- Registered Certifying Plumber or Drainlayer
- Independent qualified person (IQP)

### **Discretionary exemptions**

You can apply for a discretionary exemption through your local council. We recommend you talk to your council first before applying.

# Who can undertake exempt work

---

Some exempt building work requires that an authorised professional carry out, supervise, design or review the design of the proposed work. These professionals include:

- **Chartered Professional Engineers** for work that must be designed or have the design reviewed by a chartered professional engineer, who is registered under the Chartered Professional Engineers of New Zealand Act 2002
- **Plumbers and Drainlayers** for work that must be carried out by a person authorised under the Plumbers, Gasfitters and Drainlayers Act 2006
- **Licensed Building Practitioners (LBP)** for work that must be carried out or have the design and construction supervised by a LBP, who is registered under Part 4 of the Building Act 2004

[Chartered Professional Engineers of New Zealand Act 2002](#)

[Plumbers, Gasfitters and Drainlayers Act 2006](#)

[Building Act 2004, Part 4](#) – Regulation of building practitioners

Some other registered or licensed practitioners are deemed to be LBP for the purpose of licensing. These practitioners are entitled to use any LBP related exemptions due to their registration or licence with another regulatory authority. Practitioners deemed to be licensed are as follows:

- Registered Architects are deemed to be licensed in Design
- Chartered Professional Engineers are deemed to be licensed in Design and Site
- Certifying Plumbers are deemed to be licensed in Roofing, External Plastering and Bricklaying and Blocklaying.

Authorised professionals will be registered with their respective professional body. Each professional body has to have a public register, which enables you to check that your tradesperson or designer is authorised to carry out the work as an authorised person. You can access the relevant public registers below:

- [Register of Plumbers, Gasfitters and Drainlayers](#)
- [Register of Chartered Professional Engineers](#)
- [Register of Licensed Building Practitioners](#)
- [Register of Architects](#)
- [Register of Electricians](#)

There are also some exemptions that don't require an authorised professional. However, some of this building work may be too complex to complete without construction experience or technical understanding of the Building Code and other relevant legislation. If you're not sure how to comply, seek advice from a professional before you start your project.

# Before you start

---

## Exempt work compliance

- Exempt building work must comply with the Building Code. After the building work is completed, if the building complied with the Building Code immediately before the work commenced, the building must continue to comply. If the building did not comply immediately before the work began, the building must continue to comply at least to the same extent as it did previously (ie you cannot make the building a lower standard than prior to commencing the work).
- Exempt work must comply with any other relevant legislation, such as the Resource Management Act 1991.

## Selling property with work that has been exempted

To ensure the information about your property is kept up to date, it is recommended that you notify the council of any exempt work and provide them with relevant documentation. Councils may charge for this process.

## Checklist

Before starting any exempt building work, it is recommended that you complete the following steps during the planning stage:

1. Read this guidance document
2. Consult with a professional and/or your local council
3. Check your plans are compliant with other relevant legislation such as the Resource Management Act 1991, district plans and by-laws
4. Check your plans and specifications are compliant with the Building Code

Consider letting your council know when you have finished your project, if you'd like your property file updated.

# Amendments to building consent exemptions

MBIE works with the sector to make improvements and additions to the list of building work that can be undertaken without requiring a building consent. Amendments that have been made are outlined below to help users of this guidance understand when each of the regulation changes came into effect.

Exemptions are not retrospective. If you carry out unconsented building work which was not exempt at the time the work was undertaken, you will need to apply to your local council for a Certificate of Acceptance. You can only apply for a Certificate of Acceptance if building work was carried out without a building consent from 1 July 1992 onwards, or in specific circumstances, when a code compliance certificate can't be issued. For further information, please contact your council.

Exempted building work	Effective from	Document version
All building consent exemptions	March 2014	1
Carports	June 2016	2
Means of restricting access to small heated pools – minor amendments Retaining walls – minor amendments	August 2017	3
Ground moisture barriers	July 2019	4
Verandas and porches – additional exemption Single-storey detached buildings – three additional exemptions Carports – additional exemption Awnings – additional exemption Outdoor fireplaces or ovens Flexible water storage bladders Short-span bridges on private land without public access Pipe supporting structures Ground-mounted solar panel arrays – three new exemptions Single-storey pole sheds and hay barns	August 2020	5

# Territorial and regional authority discretionary exemptions

---

This section allows territorial authorities (city or district councils) or regional authorities (regional councils) to use their discretion to exempt any proposed building work if it complies with the Building Code and is unlikely to endanger people or buildings.

Territorial authorities or regional authorities can use their discretion to exempt any proposed building work from the requirement to obtain a building consent if;

- a. the completed building work is likely to comply with the Building Code; or
- b. if the completed building work does not comply with the Building Code, it is unlikely to endanger people or any building, whether on the same land or on other property.

This is the only exemption in Schedule 1 which requires a territorial or regional authority to make a decision about any proposed building work. For all the other exemptions, it is up to the owner to decide whether an exemption in Schedule 1 applies.

This exemption can be applied across a wide range of building work. At one end of the scale, the council may choose to exempt simple, low-risk, repetitive-type building work, such as that relating to farm buildings, proprietary garages or bus shelters. These are typically buildings of importance level 1 from Building Code clause A3 – Building importance levels.

At the other end of the scale, the building work could be for complex engineered projects where the construction will be designed and supervised by chartered professional engineers. These might include single-span bridges on public land, complex temporary stage and lighting towers, or major infrastructure projects such as motorway tunnels, electrical substations for rail networks or substantial wharf repairs. In these cases, the work is likely to comply, because skilled professionals are doing or supervising the work, and furthermore, council's processing and inspecting procedures would add little value to the overall process.

### As a building owner:

If you want your proposed building work to be considered for this exemption, we suggest that you or your agent start by discussing it with the relevant council. It is then likely that you will have to make a formal written request. The council may charge a fee for issuing a discretionary exemption.

The council will take into account what it considers the risk to be, whether your building work will comply with the Building Code and whether it will endanger people or property.

 It is recommended that you check with your council to see if they have a policy to exempt certain building work under exemption 2. This may or may not require a formal application.

### As a territorial or regional authority:

You should have procedures for making formal decisions under exemption 2 that meet the criteria of (a) and (b) above.

When determining the likelihood of compliance, we suggest your considerations include:

- any substantial previous demonstration of competence in carrying out similar work by the people who will carry out this work (eg a history of previous building work in the council's district)
- the complexity of the building work relative to the competence of the people who will carry it out
- any independent quality assurance systems or checks that will be applied in the course of the work.

In determining the likelihood of endangerment, we suggest your considerations include:

- the location of the building work (eg whether it is high density urban or remote rural)
- how close it will be to the property boundary and/or other buildings.

In all cases, we recommend that you record your decision, the reason for it and the outcome, and place this information on the property file relating to the building work.

MBIE has produced a guidance document that outlines good practice relating to the use of this exemption (which corresponds to Clause 2 of Part 1 of Schedule 1 of the Building Act 2004) and also covers some suggested policy and procedures.

[Guidance in relation to Clause 2 of Part 1 of Schedule 1 and issuing building infringement notices](#)

 Any type of building work could potentially be considered under this exemption. However, all building work carried out under this exemption should comply fully with the Building Code and all other [relevant legislation](#).

Council policies for allowing discretionary exemptions will vary depending on the scope of the building work and who is undertaking that work. Below are some examples of building work that have been accepted under this exemption. These were:

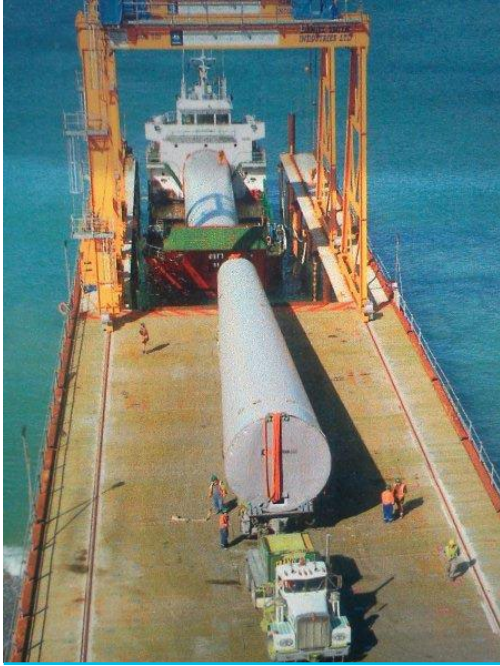

Temporary wharf

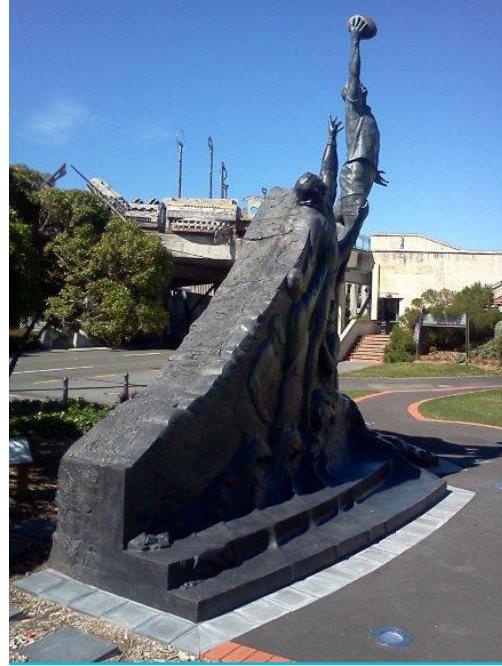

Statue



Substantial wharf repairs



Bus shelter



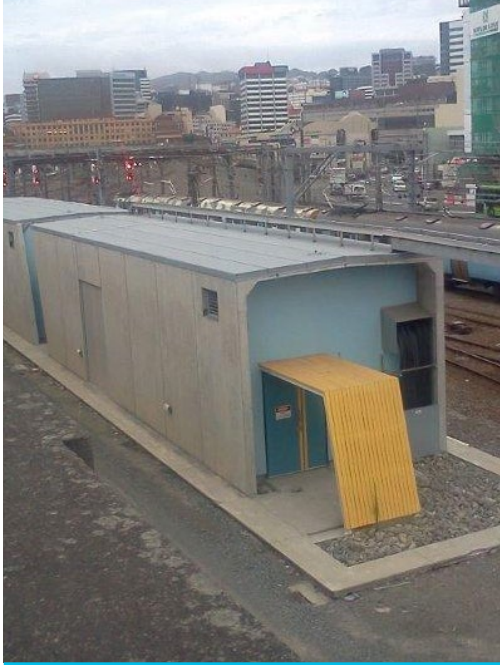

Electrical substation for the rail network

---



Retrofitting or installing thermal insulation in external walls of a standalone dwelling under certain conditions

---



Temporary tiered seating

---



## What the law says

### Schedule 1 of the Building Act 2004

#### 2. Territorial and regional authority discretionary exemptions

1. Any building work in respect of which the territorial authority or regional authority considers that a building consent is not necessary for the purposes of the Building Act 2004 because the authority considers that:
  - (a). the completed building work is likely to comply with the Building Code;  
or
  - (b). if the completed building work does not comply with the Building Code, it is unlikely to endanger people or any building, whether on the same land or on other property.





# 1. General alterations, maintenance and removal

---

This section includes exemptions for building maintenance, repairs, replacement, interior alterations, penetrations and removals.

The table below shows the exemptions included in this section and which professional may be able to provide advice as needed.

Description*	Is an authorised professional legally required?	Who can provide professional advice?
1.1. General repair, maintenance, and replacement of building parts	No	A qualified person such as a Licensed Building Practitioner, Plumber, Engineer, Electrician, Architect
1.2. Interior alterations to existing non-residential building	No	A qualified person such as a Licensed Building Practitioner, Plumber, Engineer, Electrician, Architect
1.3. Penetrations through building components	No	A qualified person such as a Licensed Building Practitioner, Plumber, Engineer, Electrician, Architect
1.4. Removal of building element	No	A qualified person such as a Licensed Building Practitioner, Plumber, Engineer, Electrician, Architect
1.5. Removal of structures	Yes	Chartered Professional Engineer

\* Owners must look at the relevant section of guidance to identify the detailed conditions the building work qualifies for the exemption under.

# 1. General alterations, maintenance and removal

---

## 1.1. General repair, maintenance, and replacement of building parts



This exemption enables building owners to maintain their buildings (including carrying out any repairs or replacement) without having to get a building consent.

MBIE has also issued relevant determinations under the Building Act 2004 that include discussion about what is considered complete or substantial replacement, and what is meant by comparable materials, components or assemblies.

[Determination 2013/071, which considered the compliance of proposed repairs to an earthquake damaged foundation.](#)

**i** If you are not sure if this exemption applies to your proposed building work, we recommend that either you seek a discretionary exemption from the council or you apply for a building consent rather than risk applying it incorrectly.

[Councils can also give discretionary exemptions ↑](#)

Check with them first before applying.

## Examples

---



### What is exempt

---

1. Replacing 20-year old profile metal roof cladding, where that cladding has achieved its Building Code durability requirement (lasted more than 15 years) and the replacement cladding is a comparable component or assembly, such as profiled metal roofing.

---

2. Replacing old rotten wooden piles under a house with new treated timber piles in the same positions, as long as the work is not a complete or substantial replacement.

---

3. Repairing and repainting damaged solid plaster exterior wall cladding where the damage was not due to a durability failure (eg, damage caused by a motor vehicle backing into the wall).

---

4. Maintaining a weatherproofing membrane such as a fibreglass and painted surface system on an existing deck that forms the roof over a habitable room by applying a new coat of fibreglass and paint in accordance with the manufacturer's instructions.

---

5. Replacing a damaged inner stainless steel flue for an existing solid fuel heater (eg a wood burner) in the same position. As the undamaged outer flue liner is remaining and will continue to protect the building against the possible spread of fire, the scope of work is not considered to be complete or substantial replacement of a component that contributes to the building's fire safety.

---

6. Replacing, in the same position, any number of existing non fire-rated wooden doors and windows (joinery and glazing) with new aluminium doors and windows.

---

7. Carrying out repairs or replacement work on the brick chimney of a functioning open fireplace following an earthquake. The repair involves using comparable materials and the scope of work is not considered to be complete or substantial replacement of any components that contribute to the building's structural behaviour or fire safety.

---

8. Repairing or replacing masonry veneer wall cladding (such as brick or stone) which has been damaged.

---

9. Simple plumbing repairs, such as replacing tap washers or ballcock valves. (Note: repairs, maintenance and replacement to sanitary plumbing and drainage must still be carried by an authorised person).

- 
10. Installing, moving or replacing smoke alarms such as those in detached dwellings, which are not part of a specified fire alarm system.

---

  11. Replacing a sprinkler head, fire pump, fire pump controller or fire pump driver with a like for like part that does not alter the performance of the sprinkler system, or relocating or adding a relatively small number of sprinkler heads within an area of a building that is already sprinkler protected.

---

  12. Rectifying minor deficiencies to a fire alarm or sprinkler system identified during an annual inspection by an Independent Qualified Person. Minor deficiencies are not considered substantial replacement of a specified system.

---

  13. Adding or relocating a relatively small proportion of fire alarm detectors and manual call points to allow for changes in the interior fit-out (eg furniture placings) or HVAC systems of a building.



### What needs consent

---

1. Replacing exterior wall cladding that has failed within 15 years of the cladding being installed, resulting in damage to the wall framing.

---

2. Rebuilding a house that has been significantly damaged by fire or earthquake. Although the building may have met its durability requirements under the Building Code, the proposed building work would involve complete and substantial replacement of structural components. Therefore, a building consent is required.

---

3. Repairing an exterior wall following vehicle impact damage where the repairs require complete replacement of wall framing and integral bracing elements.

---

4. Adding any number of sprinkler heads to an existing fire sprinkler system to protect a **previously unprotected area** in a building. This will require a building consent as it may affect the capacity of the sprinkler system.

---

5. Replacing a rigid section of fire sprinkler pipe with a flexible section will require a building consent as the parts are not similar.

---

6. Permanently removing part of a fire safety system such as a sprinkler head, detector or manual call point. Removing any of these could adversely affect the system's operation and is considered a substantial replacement of components.



7. Replacing old corrugated iron roofing with new concrete tiles. The new heavier tiles will impose an increased load on the existing structure which is likely to substantially affect the building's structural behaviour.
8. Repositioning a solid-fuel heater (eg a wood burner) by shifting it from one end of a living room to the other.
9. Replacing an existing solid-fuel heater with a comparable appliance in the same location. This will require a building consent as the installation will affect the building's fire safety properties.



### What the law says

#### Schedule 1 of the Building Act 2004

##### 1. General repair, maintenance, and replacement

1. The repair and maintenance of any component or assembly incorporated in or associated with a building, provided that comparable materials are used.
2. Replacement of any component or assembly incorporated in or associated with a building, provided that:
  - (a). a comparable component or assembly is used; and
  - (b). the replacement is in the same position.
3. However, subclauses (1) and (2) do not include the following building work:
  - (a). complete or substantial replacement of a specified system; or
  - (b). complete or substantial replacement of any component or assembly contributing to the building's structural behaviour or fire-safety properties; or
  - (c). repair or replacement (other than maintenance) of any component or assembly that has failed to satisfy the provisions of the Building Code for durability, for example, through a failure to comply with the external moisture requirements of the Building Code; or
  - (d). sanitary plumbing or drainlaying under the Plumbers, Gasfitters, and Drainlayers Act 2006.

# 1. General alterations, maintenance and removal

---

## 1.2. Interior alterations to existing non-residential building



This exemption allows internal alterations to non-residential buildings, such as fit-outs of commercial properties. It does not apply to residential buildings, including communal residential buildings such as hotels, retirement villages, camping grounds, prisons and hospitals.

If your proposed building work either modifies or affects the primary structure of the building or any specified system (eg sprinklers, fire alarms or smoke detectors), then you will need a building consent.

In addition, your building work must not relate to a wall that is a fire separation wall (firewall) or a masonry wall (ie made of blocks joined together with mortar).

For example, if you want to cut an opening through a firewall to install a fire door, this does not meet the exemption conditions in subclauses (b) and (c)(i) and will need a building consent.

Because non-residential buildings are often complex, we recommend that you seek advice from people with experience in the building industry such as registered architects, registered building surveyors or chartered professional engineers if you are not sure whether or not this exemption applies. If you are still unsure, we suggest you talk to your local city or district council.

-  Installing new non load-bearing walls and partitions close to sprinkler heads, smoke or heat detectors may affect the effectiveness and compliance of these fire safety systems (which are specified systems). This type of building work will almost certainly require a building consent.

## Examples

---



### What is exempt

---

1. The owner of a clothing store decides to do an internal fit-out which includes new shelving, clothes racks and simple low partitions. The proposed building work will not affect any existing specified systems and it meets the other requirements of this exemption. Therefore, a building consent is not required.
2. A restaurant owner proposes an alteration that includes redecorating, new seating areas and an extension to the bar. As this building work does not affect or modify the primary structure or any installed specified systems (including firewalls), a building consent is not required.



### What needs consent

---

1. The owner of an office building proposes to install a fire door in a firewall that separates an escape route. A building consent will be required as the work affects and modifies an existing specified system.
2. A commercial property owner wants to install some simple full height partitioning. This will involve relocating several fire sprinkler heads. As this building work is a modification to a specified system, a building consent will be required.
3. A developer has built the shell of a new commercial building for several retail tenancies. One of the tenants wishes to fit out their retail space with full height partitioning and counters for customer service. As this is the first fit-out of a new building, the building work is considered to be new and not an interior alteration to an existing non-residential building. Therefore, the proposed building work is outside the scope of this exemption and will require a building consent.



## What the law says

### Schedule 1 of the Building Act 2004

#### 10. Interior alterations to existing non-residential building

Building work in connection with the interior of any existing non-residential building (for example, a shop, office, library, factory, warehouse, church, or school) if the building work:

- (a). does not modify or affect the primary structure of the building; and
- (b). does not modify or affect any specified system; and
- (c). does not relate to a wall that is:
  - (i). a fire separation wall (also known as a firewall); or
  - (ii). made of units of material (such as brick, burnt clay, concrete, or stone) laid to a bond in and joined
  - (iii). together with mortar; and
- (d). does not include sanitary plumbing or drainlaying under the Plumbers, Gasfitters, and Drainlayers Act 2006.

# 1. General alterations, maintenance and removal

---

## 1.3. Penetrations through building components



This exemption allows you to make penetrations of a limited size (with a maximum diameter of 300 mm) through both internal and external building components without needing a building consent. It also covers any building work associated with such penetrations such as weatherproofing, fireproofing, or sealing.

These small penetrations are typically necessary to install items such as heat pumps, home ventilation systems, extractor fans and a wide range of other building services which require wiring, pipes and the like to pass through a building.

The exemption contains conditions for two categories of building:

- An existing dwelling or outbuilding, provided:
  - the dwelling is in a building that is not more than 3 storeys or the dwelling is detached
  - the outbuilding is detached and is not more than 3 storeys.
- Any building other than a dwelling or outbuilding provided the penetration:
  - does not modify or affect the primary structure of the building (which is all the structural elements of the building that are intended to contribute to resisting vertical and horizontal loads)
  - does not modify or affect any specified system.

 It is important to seek professional advice and to ensure the person carrying out the work is competent to do so, and understands the Building Code requirements in relation to the building's structural performance, weatherproofing and fire-rating. Non-compliant building work may affect any insurance cover on the building, as well as any future sale and purchase agreements.

## Examples

---



### What is exempt

---

1. Installing a heat pump into a detached dwelling via a 100 millimetre diameter wall penetration through an external load-bearing wall.

---

2. Installing an extractor fan above a kitchen hob in a 4 storey detached dwelling. The fan is vented through the roof with a 200 millimetre diameter duct.

---

3. An owner has a single level apartment on the first floor of a 3 storey mixed-use building with retail spaces on the ground floor. The apartment owner intends to install an extract fan in a bathroom and vent it via a 290 millimetre diameter duct which penetrates an external firewall containing a bracing element.

---

4. Installing a closed-circuit television surveillance system with several 50 millimetre diameter penetrations through a load-bearing external wall of an outbuilding.

---

5. Fitting a security alarm box and associated cabling to an industrial building's external envelope which requires a 20 millimetre diameter penetration to be drilled and sealed in a non-structural masonry wall.



### What needs consent

---

1. An extract fan in a commercial kitchen is vented via a 250 millimetre diameter duct which penetrates a primary structure beam on the external wall. Although the penetration is less than 300 mm in diameter, as the penetration affects the primary structure of a commercial building it will require a building consent.

---

2. Providing a 400 millimetre x 400 millimetre roof penetration between the trusses of a commercial building to provide for a natural ventilation duct to a staff changing area. As the penetration dimensions are greater than 300 millimetre in diameter, a building consent is required.



## What the law says

### Schedule 1 of the Building Act 2004

#### 14. Penetrations

1. Building work in connection with the making of a penetration not exceeding 300 millimetres in diameter to enable the passage of pipes, cables, ducts, wires, hoses, and the like through any existing dwelling or outbuilding and any associated building work, such as weatherproofing, fireproofing, or sealing, provided that:
  - (a). in the case of a dwelling, the dwelling is detached or in a building that is not more than 3 storeys; and
  - (b). in the case of an outbuilding, the outbuilding is detached and is not more than 3 storeys.
  
2. In the case of an existing building to which subclause (1) does not apply, building work in connection with the making of a penetration not exceeding 300 millimetres in diameter to enable the passage of pipes, cables, ducts, wires, hoses, and the like through the building and any associated building work, such as weatherproofing, fireproofing, or sealing, provided that the penetration:
  - (a). does not modify or affect the primary structure of the building; and
  - (b). does not modify or affect any specified system.

# 1. General alterations, maintenance and removal

---

## 1.4. Removal of building element



This exemption applies to the removal of a building element such as a chimney or roof (including cladding) rather than to the complete demolition of a building.

It is limited to any building up to 3 storeys high as long as the removal does not affect the primary structure, any specified system or any fire separation (which includes firewalls protecting other property).

Note that any repair work associated with removing a building element can be done under exemption 1 (repairs, maintenance, and replacement). For example, removing an external chimney will require the making good of the gaps left in the wall and roof claddings.



All new building work must comply with the Building Code, including its structural performance requirements. On completion of the building work, the altered building must comply with the Building Code to at least the same extent as it did before the building work was undertaken.

If you are considering building work that is close to or involves potentially load-bearing walls, it is important to get professional advice.



## Examples



### What is exempt

1. Removing all non-load-bearing masonry walls (internal and external) in a 3 storey commercial building, except those that are fire separations.
2. A home owner proposes to reduce the likelihood of earthquake damage to their house by completely removing a brick chimney located on an external wall. A designer inspects this and advises the owner that the chimney building element is independent of the house's primary structure.
3. A building owner wishes to demolish the upper portion of a chimney (ie above the roof) of a redundant fireplace so as to reduce possible property damage in the event of an earthquake.



### What needs consent

1. A home owner wishes to completely demolish an internal masonry chimney between the dining and living rooms. A builder inspects the roof space and finds that the chimney is load-bearing as it supports some of the roof rafters and ceiling joists. As removing the chimney will affect the primary structure of the house, the proposed building work will require a building consent.
2. An owner of a 3 storey office and retail building wants to reduce the risk of injuring office occupants on the middle floor in any future earthquake. They propose to entirely remove the suspended ceiling grid which supports the heavy fibrous plaster tiles and expose the underside of the upper floor slab. Since the building has a heat detection emergency warning system, the proposed removal of the building element (ie the suspended ceiling) will affect this specified system. Therefore, a building consent will be required to do this work.



### What the law says

#### Schedule 1 of the Building Act 2004

#### 31. Removal of building element

The removal of a building element from a building that is not more than 3 storeys, provided that the removal does not affect:

- (a). the primary structure of the building; or
- (b). any specified system; or
- (c). any fire separation.

# 1. General alterations, maintenance and removal

---

## 1.5. Removal of structures



Legally required professional:

**Chartered Professional Engineer**

This exemption was introduced to cover the removal of any building work for which the design was carried out or reviewed by a chartered professional engineer because their removal is not included in the respective exemptions 39 to 49 (sections 12.2., 14.6., 13.3., 10.2., 2.3., 8.2., 8.7., 6.2., 7.2., 14.2. and 2.6.).

## Examples

---



### What is exempt

---

1. Removing a billboard from the side of a multi-storey apartment building.
2. The new owner of a licensed childcare centre decides to remove a 4.5 metre high slide constructed by the previous owner.



### What needs consent

---

1. Removing a 4 metre high rural retaining wall which is supporting other structures (eg a driveway and building).



### What the law says

Schedule 1 of the Building Act 2004

---

#### 50. Removal of structures

The removal of any of the structures referred to in exemptions 39 to 49, whether or not the design of the structure has been carried out or reviewed by a Chartered Professional Engineer.

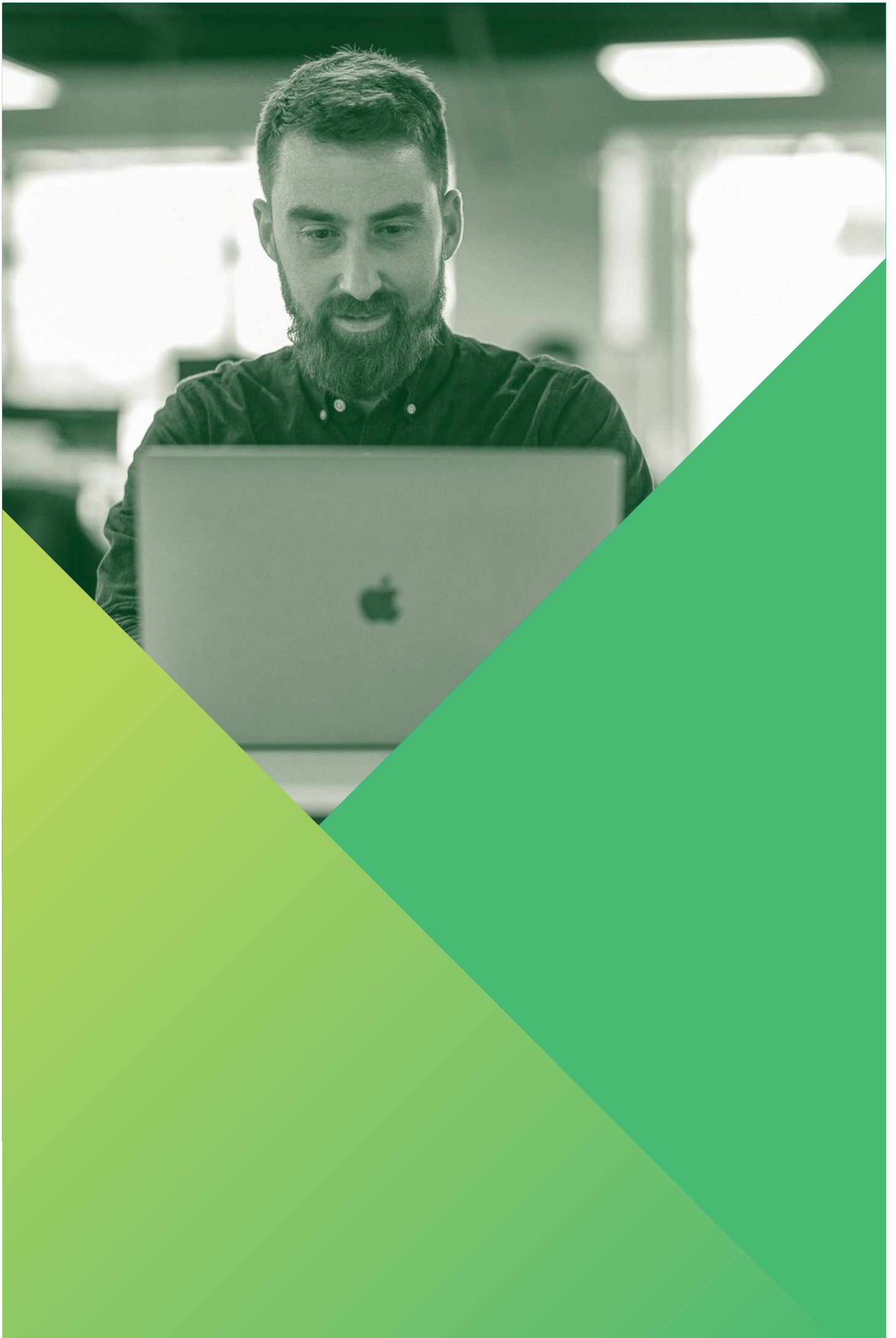

## 2. Detached, standalone buildings

This section refers to the construction or demolition of single-storey detached buildings or outbuildings under certain conditions.

The table below shows the exemptions included in this section and the professional you will need to hire if needed.

Description	Is an authorised professional legally required?	Who can provide professional advice?
2.1. Single-storey detached buildings less than 10 square metres	No	Licensed Building Practitioner or Chartered Professional Engineer or Registered Architect
2.2. Single-storey detached buildings exceeding 10, but not exceeding 30, square metres in floor area, constructed of lightweight material	No	Licensed Building Practitioner or Chartered Professional Engineer or Registered Architect
2.3. Single-storey detached buildings not exceeding 30 square metres in floor area with prefabricated or kitset components	Yes	Chartered Professional Engineer
2.4. Single-storey detached buildings not exceeding 30 square metres in floor area	Yes	Licensed Building Practitioner and/or Registered Architect
2.5. Unoccupied detached buildings for housing fixed plants or machinery	No	Licensed Building Practitioner or Chartered Professional Engineer or Registered Architect
2.6. Single-storey pole sheds and hay barns in rural zones	Yes	Chartered Professional Engineer
2.7. Single-storey pole sheds and hay barns in rural zones	Yes	Licensed Building Practitioner or Registered Architect
2.8. Repair or replacement of existing outbuilding	No	Licensed Building Practitioner or Registered Architect
2.9. Demolition of detached building	No	Licensed Building Practitioner or Chartered Professional Engineer or Registered Architect

## Notes for single-storey detached buildings: 2.1-2.5

---

Sections 2.1-2.5 cover five separate exemptions for single-storey detached buildings.

- Buildings up to 10 square metres in floor area
- Single-storey detached buildings exceeding 10, but not exceeding 30 square metres in floor area, constructed of lightweight materials
- Buildings up to 30 square metres in floor area using a kitset or prefabricated building where a manufacturer or supplier has had the design carried out or reviewed by a Chartered Professional Engineer
- Buildings up to 30 square metres in floor area where a Licensed Building Practitioner is to carry out or supervise design and construction.
- Unoccupied detached buildings

**Before you begin your project, you need to consider the following:**

---

### **Durability**

The Building Code requires building materials, components and construction methods to be sufficiently durable to ensure the building (without reconstruction or major renovation) satisfies the other functional requirements of the Building Code for the life of the building.

### **Smoke alarms**

You must install smoke alarms if the detached building is going to be used for sleeping. Please refer to [Acceptable Solution F7/AS1](#) for more information on the location and type of smoke alarms to install. It is recommended that any smoke alarm in a sleepout is interconnected with the smoke alarms in the main dwelling.

[Compliance Document for New Zealand Building Code Clause F7 Warning Systems](#) which includes Acceptable Solution F7/AS1.

### Stormwater

You need to consider the Building Code requirements regarding the disposal of stormwater from the roof of your building. You should seek professional guidance and seek approval from your council. All new drains must be laid by an authorised drainlayer.

### On-site waste water disposal systems

If the building is intended to be a sleepout in connection with an existing dwelling, and the waste water from the existing dwelling discharges to an on-site waste water disposal system (ie a septic tank), you need to check that the existing waste water disposal system has the capacity for the extra persons.

### Location of services

You need to confirm the location of any underground services that could affect the location of the build. Check with your local council and an underground services location company to ensure you are not building over any existing below ground services, such as drains, electricity, gas, telecommunications etc

### District planning

Always check with your local council to make sure your proposed building work does not have any district or regional planning implications taking consideration of maximum site coverage, yard or setback requirements, daylight access planes or permitted activities. A resource consent may be required and it is important that this is obtained before starting any building work.

### Building close to boundaries

If you are building close to boundaries, you need to consider the Building Code requirements regarding protection from fire, particularly in relation to the external spread of fire to neighbouring property.

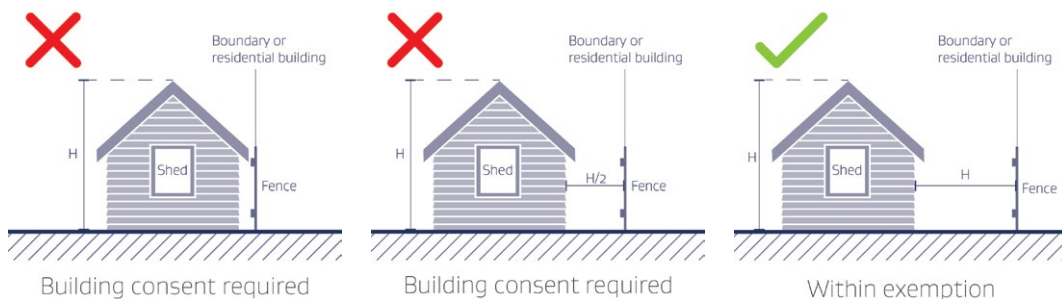

### Measuring the net floor area

The net floor area in a building is measured to the inside of the enclosing walls or posts/columns.

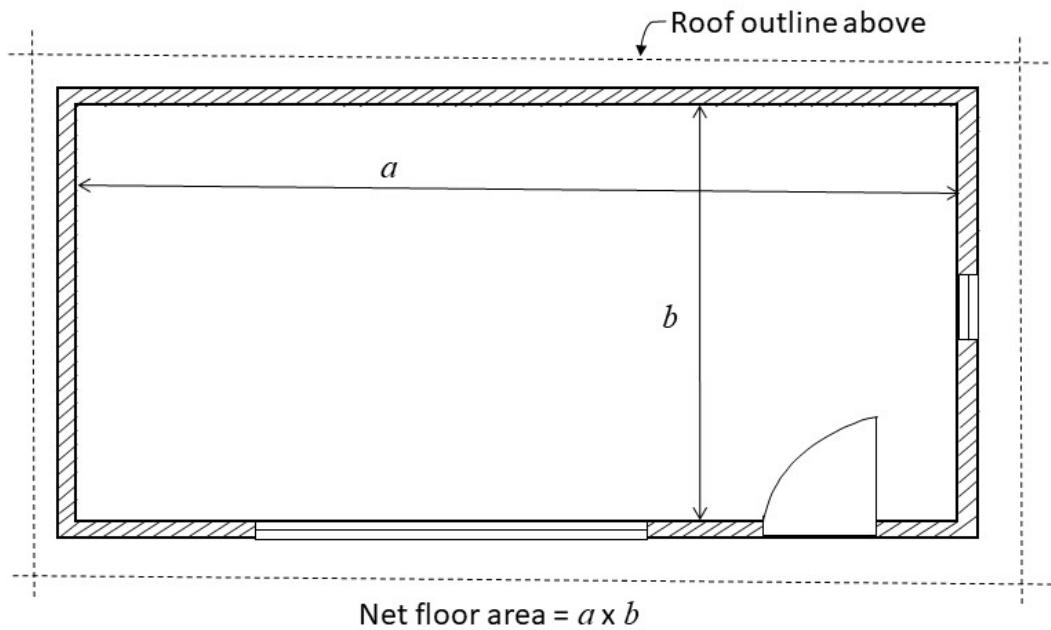

### Note for manufacturers of prefabricated buildings

If you are a supplier or manufacturer of proprietary garden sheds, greenhouses, cabins or sleepouts, we recommend that you make sure anyone buying them is aware of the how the small building is to be used and located in order to be exempt from needing a building consent. If a small building is not used or located as required by the exemption, the purchaser will need to apply for a building consent.



## 2. Detached, standalone buildings

---

### 2.1. Single-storey detached buildings less than 10 square metres



This exemption covers the construction of small detached buildings such as garden sheds, greenhouses, cabins or sleepouts.

Before you begin, please read the notes for single-storey detached buildings on page 38.

The Building Code requires building materials, components and construction methods to be sufficiently durable to ensure the building (without reconstruction or major renovation) satisfies the other functional requirements of the Building Code for the life of the building.

## Examples

---



### What is exempt

---

1. A 9 square metre sleepout is constructed in the backyard of a residential dwelling. It is more than its own height away from all boundaries and the associated residential dwelling, and does not contain cooking or sanitary facilities, or a potable water supply.

---

2. Owners of a childcare centre intend to build a 10 square metres detached building to serve as a staff retreat area. The proposed building will be more than its own height away from the boundaries. It contains no potable water supply and no facilities for cooking or sanitation.



### What needs consent

---

1. A rural land owner decides to erect a 10 square metre sleepout on a property that does not have a residential dwelling on it. This sleepout would require a building consent as it is not associated with a residential dwelling.

---

2. A building owner erects a kitset garden shed that is 2 metres high. It is located 1 metre from the boundary. This garden shed would require a building consent as it is not its own height away from the boundary.

---

3. A home owner decides to build a detached 10 square metre sleepout on the back of their 1000 square metre section. The sleepout floor level is 900 millimetres above the supporting ground and the apex of the roof is 3.5 metres above the floor level. The sleepout is also more than its own height away (4.4 metres) from the house and the boundaries. The owner decides to optimise the sleepout space by including a loft of 8 square metres as a study area. As the proposed floor level of the loft is more than 1 metre above the supporting ground, a building consent will be required.



## What the law says

### Schedule 1 of the Building Act 2004

#### 3. Single-storey detached buildings not exceeding 10 square metres in floor area

1. Building work in connection with any detached building that:
  - (a). is not more than 1 storey (being a floor level of up to 1 metre above the supporting ground and a height of up to 3.5 metres above the floor level); and
  - (b). does not exceed 10 square metres in floor area; and
  - (c). does not contain sanitary facilities or facilities for the storage of potable water; and
  - (d). does not include sleeping accommodation, unless the building is used in connection with a dwelling and does not contain any cooking facilities.
2. However, subclause (1) does not include building work in connection with a building that is closer than the measure of its own height to any residential building or to any legal boundary.

## 2. Detached, standalone buildings

---

### 2.2. Single-storey detached buildings exceeding 10, but not exceeding 30, square metres in floor area and constructed of lightweight material



This exemption covers the construction of small buildings such as garden sheds, greenhouses, cabins or sleepouts greater than 10 square metres but less than 30 square metres. Before you begin, please read the notes for single-storey detached buildings on page 38.

If you are providing sleeping accommodation in such a building, note that the facilities (such as potable water) of an existing dwelling must be readily available and used for sanitation, and the building cannot include cooking facilities because of the risk of fire.

The net floor area of a single storey, detached building is limited to a maximum of 30 square metres. If you are extending an existing single storey detached building, the maximum combined net floor area cannot exceed 30 square metres.

To qualify for this exemption, only lightweight materials such as light timber or steel framing and cladding must be used for the construction of buildings and the structural components must be designed and built in accordance to Building Code compliance document B1/AS1. Currently, NZS 3604:2011 and National Association of Steel Framed Housing standards cited in the Building Code are used as an Acceptable Solution

(B1/AS1) for residential buildings with light timber and light steel framing respectively. “Lightweight” means that either timber or steel are used for the structural framing, and the roof and wall cladding are “light” in accordance with NZS 3604 definitions (roofs less than 20 kilograms/square metre and cladding less than 30 kilograms/square metre). The foundations can be concrete.

[NZS 3604:2011 Timber-framed buildings](#) which is used as Acceptable Solution (B1/AS1)

[National Association of Steel Framed Housing Inc](#)

If you have difficulty with understanding how to apply the technical requirements of B1/AS1 to a particular building, professional advice of qualified people should be sought.

 Where B1/AS1 (NZS3604:2011) is being used as a means of compliance for detached buildings, bracing lines should not exceed 6 metres in any direction for ground floor construction and be no more than 5 metres apart for subfloor areas. These requirements help to evenly distribute bracing throughout the building and avoid a disproportionate concentration of bracing in any one area.

## Examples

---



### What is exempt

---

1. The owners of a commercial property intend to construct a 20 square metre detached building to serve as a garage. The proposed building will be more than its own height away from the boundaries, it contains no potable water supply, and no facilities for cooking or sanitation. The owners want to construct the building from the lightweight materials in accordance with the technical requirements of the Building Code as specified in B1/AS1.

---

2. A 28 square metre sleepout is constructed in the backyard of a residential dwelling. It is more than its own height away from all boundaries and the associated residential dwelling, and does not contain cooking or sanitary facilities, or a potable water supply. The design complies with the technical requirements of the Building Code for the lightweight material per B1/AS1. Subsequently, the construction is carried out in accordance with that design.

---

3. A 26 square metre detached single garage is constructed on a concrete slab of a property with a residential dwelling. It is more than its own height away from all boundaries and the associated residential dwelling, and does not contain cooking or sanitary facilities, or a potable water supply. Plans and specifications comply with the technical requirements of the Building Code for the lightweight timber material per B1/AS1. Subsequently, the work is carried out in accordance with that design.



### What needs consent

---

1. A homeowner decides to erect a sleepout with a net floor area of 33 square metres on a property that has a residential dwelling on it. This sleepout would require a building consent as its floor area is greater than 30 square metres

---

2. A homeowner intends to construct a sleepout with a net floor area of 29 square metres on a property that has a residential dwelling on it. Heavy concrete masonry units are proposed for construction of perimeter walls. This sleepout would require a building consent because the proposed material for the construction is not lightweight material (If the homeowner had the proposed building constructed or supervised by a licensed building practitioner under exemption 3B (section 2.4), then a building consent would not be required).

3. A homeowner intends to construct a storage shed with a net floor area of 20 square metres on a property that has a residential dwelling. Reinforced concrete panels are proposed for construction of this building. This shed would require a building consent because the proposed material for the construction is not lightweight material (if the homeowner had the proposed building constructed or supervised by a licensed building practitioner under exemption 3B (section 2.4.), then a building consent would not be required).
4. A homeowner wants to construct a sleepout with a net floor area of 20 square metres on a property that has a residential dwelling. The owner also wants to construct an elevated loft of 8 square metres 1.2 metres above the ground level. This sleepout would require a building consent because the proposed level for the loft area is more than 900 millimetres above the ground.



### What the law says

#### Schedule 1 of the Building Act 2004

#### 3A. Single-storey detached buildings exceeding 10, but not exceeding 30, square metres in floor area, constructed of lightweight material

1. Building work in connection with any detached building that—
  - (a). is not more than 1 storey (being a floor level of up to 1 metre above the supporting ground and a height of up to 3.5 metres above the floor level); and
  - (b). exceeds 10 square metres in floor area, but does not exceed 30 square metres; and
  - (c). is built using lightweight wall and roof materials, and in accordance with Acceptable Solution B1/AS1 for timber or steel buildings; and
  - (d). does not contain sanitary facilities or facilities for the storage of potable water; and
  - (e). does not include sleeping accommodation, unless the building is used in connection with a dwelling and does not contain any cooking facilities; and
  - (f). if it includes sleeping accommodation, has smoke alarms installed.
2. (2) However, subclause (1) does not include building work in connection with a building that is closer than the measure of its own height to any residential building or to any legal boundary.

## 2. Detached, standalone buildings

---

### 2.3. Single-storey detached buildings not exceeding 30 square metres in floor area with prefabricated or kitset components



Legally required professional:

**Chartered Professional Engineer**

This exemption covers the construction of small buildings such as garden sheds, greenhouses, cabins or sleepouts greater than 10 square metres but less than 30 square metres.

Before you begin, please read the notes for single-storey detached buildings on page 38.

If you are providing sleeping accommodation in such a building, note that the facilities (eg portable water) of an existing dwelling must be readily available and used for sanitation, and the building cannot include cooking facilities because of the risk of fire.

If you are purchasing a prefabricated or kitset building, you will need to check with the manufacturer or supplier that a chartered professional engineer has designed or reviewed the building. Homeowners must also seek and follow manufacturers/supplier instructions to ensure that the building work be carried out in accordance with that design.



The net floor area of a single storey, detached building is limited to a maximum of 30 square metres.

The net floor area in a building is measured to the inside of the enclosing walls or posts/columns.

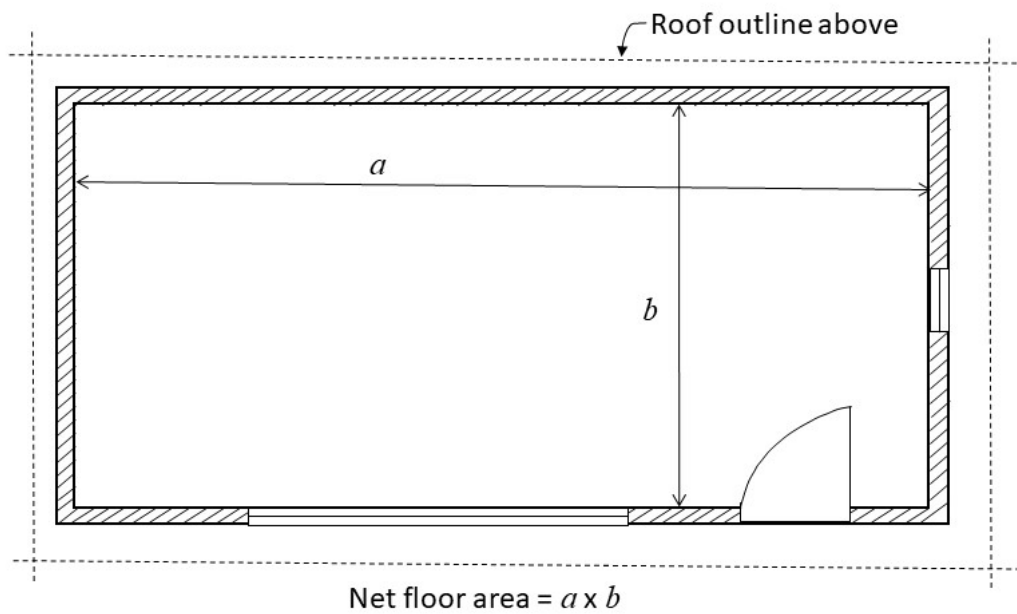

Some suppliers and manufacturers of proprietary products have pre-engineered kitsets with a unified sign-off from a chartered professional engineer. These kitsets must be constructed in accordance with the instructions and the design approved by the engineer.

## Examples

---



### What is exempt

---

1. The owners of a commercial property intend to construct a 30 square metre detached building to serve as a garage. The proposed building will be more than its own height away from the boundaries and it contains no potable water supply and no facilities for cooking or sanitation. The owners want to buy a pre-engineered kitset from a proprietary product supplier or manufacturer which has been signed off by a chartered professional engineer for design. The kitset is then installed by the property owner in accordance with the instruction manual.
2. A 25 square metre sleepout is constructed in the backyard of a residential dwelling. It is more than its own height away from all boundaries and the associated residential dwelling, and does not contain cooking or sanitary facilities, or a potable water supply. Plans and specifications associated with the kitsets and prefabs are signed off by a chartered professional engineer. Subsequently, the work is carried out in accordance with that design.



### What needs consent

---

1. A homeowner decides to build a sleepout with a net floor area of 31 square metres on a property that has a residential dwelling on it. This sleepout would require a building consent as its floor area is greater than 30 square metres.
2. A homeowner decides to construct a greenhouse with a net floor area of 25 square metres on a property that has a residential dwelling on it. The prefabricated greenhouse is imported from overseas without design sign off from a Chartered Professional Engineer. This greenhouse would require a building consent as the greenhouse was not designed or reviewed by a chartered professional engineer.
3. A 25 square metre sleepout is constructed in the backyard of a residential dwelling. It is more than its own height away from all boundaries and the associated residential dwelling, and does not contain cooking or sanitary facilities or a potable water supply. Although the building designed by a chartered professional engineer, the building is not made of kitset or prefabricated products. The building will require a building consent because the structural components are not kitset or prefabricated products (exemption 3B may apply if the work is carried out or supervised by a licensed building practitioner).



## What the law says

### Schedule 1 of the Building Act 2004

#### 43. Single-storey detached buildings exceeding 10, but not exceeding 30, square metres in floor area (where kitset or prefabricated)

1. Building work in connection with any detached building if—
  - (a). the building is a kitset or prefabricated building, and the product manufacturer or supplier has complied with subclause (3); and
  - (b). the building work is carried out in accordance with the design referred to in subclause (3); and
  - (c). the building—
    - (i). is not more than 1 storey (being a floor level of up to 1 metre above the supporting ground and a height of up to 3.5 metres above the floor level); and
    - (ii). exceeds 10 square metres in floor area, but does not exceed 30 square metres; and
    - (iii). does not contain sanitary facilities or facilities for the storage of potable water; and
    - (iv). does not include sleeping accommodation, unless the building is used in connection with a dwelling and does not contain any cooking facilities; and
    - (v). if it includes sleeping accommodation, has smoke alarms installed.
2. However, subclause (1) does not include building work in connection with a building that is closer than the measure of its own height to any residential building or to any legal boundary.
3. The product manufacturer or supplier (as defined in section 14G) must have had the design of the building carried out or reviewed by a chartered professional engineer.

## 2. Detached, standalone buildings

---

### 2.4. Single-storey detached buildings not exceeding 30 square metres in floor area



Legally required professional:

Licensed Building Practitioner

This exemption covers the construction of small buildings such as garden sheds, greenhouses, cabins or sleepouts greater than 10 square metres but less than 30 square metres.

Before you begin, please read the notes for single-storey detached buildings on page 38.

The net floor area of a single storey, detached building is limited to a maximum of 30 square metres. If you are extending an existing single storey detached building, the maximum total net floor area cannot exceed 30 square metres.

The net floor area in a building is measured to the inside of the enclosing walls or posts/columns.

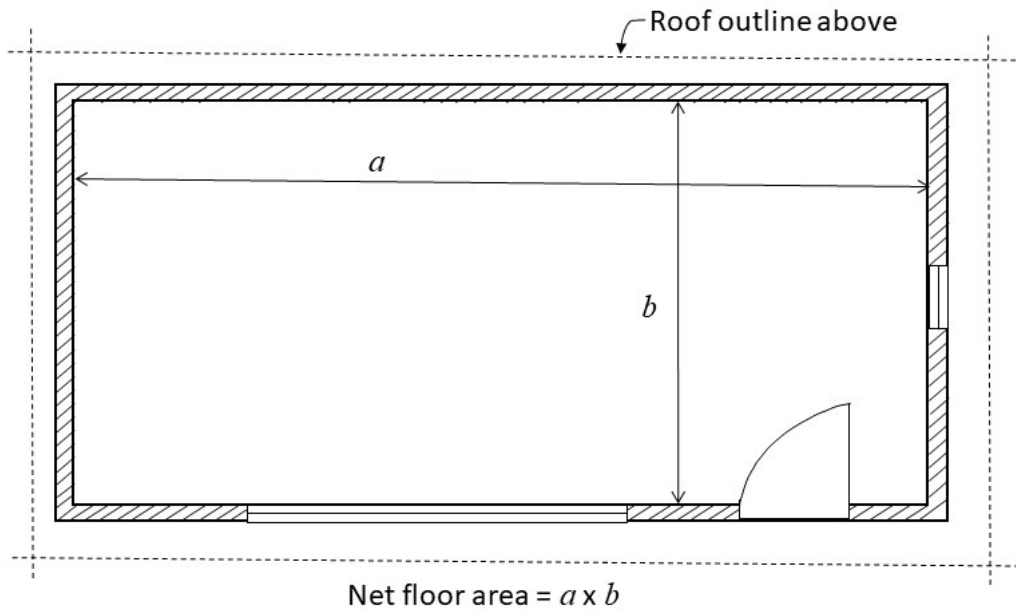

Any design or construction work done using this exemption must be carried out or supervised by a Licensed Building Practitioner (LBP). Homeowners are encouraged to seek LBPs with the right competence for this work, as this provides the best assurance.

The design work is best carried out by an LBP holding a Design license or a Registered architect. The construction work is best carried out by an LBP in one of the following licensing classes, as may be relevant to the building work planned to be undertaken:

- Bricklaying and blocklaying
- Carpentry
- External plastering
- Foundations
- Roofing

Refer to the Who can undertake exempt work section on page 11 for more information about Licensed Building Practitioners.

**i** You should also check and confirm the LBPs current licensing status and licensing history before you engage them to carry out work under this exemption.

## Examples

---



### What is exempt

---

1. The owners of a commercial property intend to construct a 20 square metre detached building to serve as a garage. The proposed building will be more than its own height away from the boundaries and contains no potable water supply, and no facilities for cooking or sanitation. As the owners have contracted a Licensed Building Practitioner to design and construct or supervise the building work, a building consent is not required.

---

2. A 28 square metre sleepout is constructed in the backyard of a residential dwelling. It is more than its own height away from all boundaries and the associated residential dwelling, and does not contain cooking or sanitary facilities, or a potable water supply. The design complies with the technical requirements of the Building Code and was prepared or supervised by a Licensed Building Practitioner. Subsequently, the work is carried out or supervised by a Licensed Building Practitioner in accordance with that design. Fire alarms are specified and installed in accordance with Acceptable Solution F7/AS1 as this building contains sleeping accommodation.

---

3. A rural land owner decides to erect a shed with a net floor area of 30 square metres on a property that does not have a residential dwelling on it. This shed will be more than its own height away from the boundaries and it includes no accommodation, cooking or sanitary facilities or potable water supply. The design and construction will be carried out and supervised by Licensed Building Practitioners.



### Whats needs consent

---

1. A homeowner wishes to erect a sleepout with a net floor area of 33 square metres on a property that has a residential dwelling on it. This sleepout would require a building consent as its floor area is greater than 30 square metres.

---

2. A building owner erects a building to store products in. The building contains no sleeping accommodation, cooking or sanitary facilities or potable water supply. The building will be 5 metres in height to the apex of the roof, meaning it cannot be built under this exemption as it is more than 4.5 metres high (1 metre to floor level, plus 3.5 metre building height).

---

3. A homeowner intends to construct a flat at the back of their property with a net floor area of 29 square metres. This flat will have sleeping accommodation as well as a small kitchen. As this building will contain cooking facilities, it requires a building consent.

4. A rural land owner wants to add a building with concrete block walls to support their farm operation. The net floor area of the building will be 12 square metres. The land owner wants to do it themselves to save money so they are unable to use this exemption as this exemption requires the use of a Licensed Building Practitioner.



### What the law says

#### Schedule 1 of the Building Act 2004

#### 3B. Single-storey detached buildings exceeding 10, but not exceeding 30, square metres in floor area if work carried out or supervised by licensed building practitioner

1. Building work in connection with any detached building if—
  - (a). any design or construction work is carried out or supervised by a Licensed Building Practitioner; and
  - (b). the building—
    - (i). is not more than 1 storey (being a floor level of up to 1 metre above the supporting ground and a height of up to 3.5 metres above the floor level); and
    - (ii). exceeds 10 square metres in floor area, but does not exceed 30 square metres; and
    - (iii). does not contain sanitary facilities or facilities for the storage of potable water; and
    - (iv). does not include sleeping accommodation, unless the building is used in connection with a dwelling and does not contain any cooking facilities; and
    - (v). if it includes sleeping accommodation, has smoke alarms installed.
2. However, subclause (1) does not include building work in connection with a building that is closer than the measure of its own height to any residential building or to any legal boundary.

## 2. Detached, standalone buildings

---

### 2.5. Unoccupied detached buildings for housing fixed plants or machinery



This exemption covers specific types of building that:

- would not normally pose a risk to people
- are only used by people engaged in constructing or maintaining another consented building, such as a construction site office.

### Examples

---



#### What is exempt

---

1. Owners of an industrial complex are installing a new compressor which needs to be protected from the weather. They construct a 3 metre high building with a 15 square metre net floor area to house the compressor, which only requires maintenance once a month. The building is sited 7 metres from the closest boundary.
2. A purpose-built construction site office that has a 20 square metre net floor area and is 2.4 metres high is located on a consented commercial building site. It is 3 metres from the nearest boundary and is only used by people engaged in constructing the building.





### What needs consent

1. An industrial building owner wants to construct a building in an area that people do not normally enter. The building will also be further than its own height away from any residential building or legal boundary. However, as the building will contain chemicals that require it to be authorised under the Health and Safety at Work Act 2015, a building consent will be required.
2. A building supply merchant intends to build a security building at the exit barrier of their premises, on the property boundary. It will be 12 square metres by 3 metres high. As they plan to locate the building less than its own height from the nearest boundary, they will need to apply for a building consent.



### What the law says

#### Schedule 1 of the Building Act 2004

#### 4. Unoccupied detached buildings

1. Building work in connection with any detached building that:
  - (a). houses fixed plant or machinery and under normal circumstances is entered only on intermittent occasions for the routine inspection and maintenance of that plant or machinery; or
  - (b). is a building, or is in a vicinity, that people cannot enter or do not normally enter; or
  - (c). is used only by people engaged in building work:
    - (i). in relation to another building; and
    - (ii). for which a building consent is required.
2. However, subclause (1) does not include building work in connection with a building that is closer than the measure of its own height to any residential building or to any legal boundary.

# Notes for Single-storey pole sheds and hay barns in rural zones: 2.6-2.7

---

There are two separate exemptions for single-storey pole sheds and hay barns. You will need to check which professional to hire according to the specifications.

- Single-storey pole sheds and hay barns up to 110 square metres in net floor area where the design is carried out or reviewed by a chartered professional engineer.
- Single-storey pole sheds and hay barns up to 110 square metres in net floor area where the design and construction is carried out or supervised by a licensed building practitioner.

**Before you begin your project, you need to consider the following:**

---

## **Change of use**

Owners must not convert a pole shed or hay barn to another type of use, particularly those involving public access (such as farm shops or wine tasting facilities) unless the owner notifies the council on the proposed change of use as required by section 114 of the Building Act 2004.

## **Stormwater**

You need to consider the Building Code requirements regarding the disposal of stormwater from the roof of your building. You may need to seek professional guidance and seek approval from your council. All new drains must be laid by an authorised drainlayer.

## **District planning**

Always check with your local council to make sure your proposed building work does not have any district planning implications taking consideration of maximum site coverage, yard or setback requirements, daylight access planes or permitted activities. A resource consent may be required and it is important that this is obtained before starting any building work.

Pole sheds and hay barns can be enclosed, semi-enclosed or open structures which are used for farming activities in rural zones. They commonly house livestock, such as cattle and horses, as well as equipment and fodder, and often grain. Pole sheds and hay barns covered in this exemption are expected to be classified as Importance level 1 in accordance with Clause A3 of the Building Code.

This exemption is location dependent. Firstly, single-storey pole sheds and hay barns must be located in rural zones as defined in the glossary of this document. Secondly, the design wind speed at a given location must not exceed 44 metres per second or alternatively, a wind zone shall not be greater than a “high” wind zone. An owner can find information about design wind speed in NZS 3604 and AS/NZS 1170.2 which are both referenced by B1/VM1 or B1/AS1. Most councils also have generic wind zone information for their jurisdiction, and owners can seek professional advice to determine the design wind speed or the wind zone in specific locations. If your council doesn’t have wind maps, you must seek professional advice.

[NZS 3604 Timber-framed buildings](#) which references design wind zones.

[AS/NZS 1170.2:2011](#) which references design wind speeds.

### Measuring the net floor area

The net floor area in a building is measured to the inside of the enclosing walls or posts/columns. There is no restriction on the building materials that can be used.

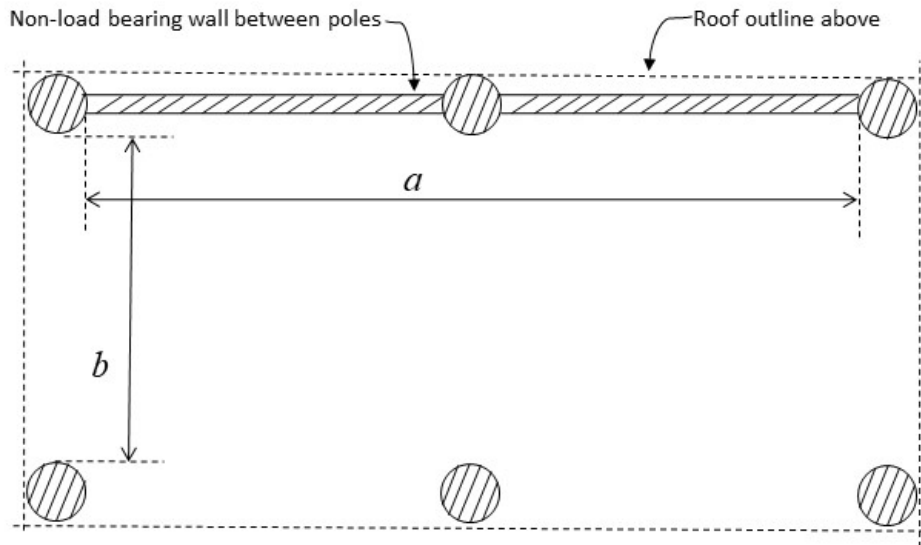

$$\text{Net floor area} = a \times b$$

## 2. Detached, standalone buildings

---

### 2.6. Single-storey pole sheds and hay barns



Legally required professional:

**Chartered Professional Engineer**

Before you begin, please read the notes for single-storey pole sheds and hay barns on page 58.

There is no restriction on the type of material used. To use this exemption, an owner must engage a Chartered Professional Engineer (it is best to use a structural engineer) to design or review the hay barn or pole shed as long as the net floor areas does not exceed 110 square metres and the building work is carried out in accordance with the design. Some suppliers and manufacturers of proprietary products have pre-engineered kitsets with a unified sign-off from a Chartered Professional Engineer in which the owner can assemble on their property in accordance with the design. You may need a Licensed Building Practitioner to erect these buildings in accordance with the Chartered Professional Engineer.

-  Since the record of undertaken exempted building work might not be available in the council records, any change of use to the buildings involving public access (by the current owner or any prospective purchaser) might create additional risks to the users of the building or other properties.

## Examples

---



### What is exempt

---

1. A rural farm owner wants to erect a hay barn with a net floor area of 80 square metres and with a maximum height of 3.6 metres. The proposed barn will be located 5 metres from the existing farm house. The local council maps classify the site as a high wind zone. The owner wants to purchase a pre-engineered kitset which has design sign off from a Chartered Professional Engineer and it is intended that the building work will be carried out in accordance with that design.



### What needs consent

---

1. An owner of a farm in a rural zone wants to build a pole shed with a net floor area of 135 square metres. A building consent is required because the net floor area exceeds 110 square metres.

---

2. An owner of a farm in a rural zone wants to build a pole shed with a net floor area of 100 square metres to store small agricultural equipment. The building site is in an extra high wind zone. A building consent is required because the wind zone exceeds a "high" rating.

---

3. An owner of a farm in a rural zone wants to build a pole shed with a net floor area of 100 square metres to store some agrichemical, solvents or similar products which are hazardous substances according to the Health and Safety at Work (Hazardous Substances) Regulations 2017. A building consent is required because the hazardous substances can create significant risk and are outside the scope of this exemption.



## What the law says

### Schedule 1 of the Building Act 2004

#### 49. Single-storey pole sheds and hay barns

1. Building work in connection with a pole shed or hay barn in a rural zone if—
  - (a). the building is not more than 1 storey (being a floor level of up to 1 metre above the supporting ground and a height of up to 4 metres above the floor level); and
  - (b). the building does not exceed 110 square metres in floor area; and
  - (c). the maximum unsupported roof span in any direction does not exceed 6 metres; and
  - (d). the building is not accessible by the public; and
  - (e). the building is not used to store hazardous substances within the meaning of that term in regulation 4 of the Health and Safety at Work (Hazardous Substances) Regulations 2017; and
  - (f). either—
    - (i). the design wind speeds do not exceed 44 metres per second (calculated using Verification Method B1/VM1); or
    - (ii). the building is located in a wind zone no greater than high (as defined in Acceptable Solution B1/AS1).
2. However, subclause (1) does not include any building work in connection with a building that is closer than the measure of its own height to any residential building, public road, railway, or legal boundary.

## 2. Detached, standalone buildings

---

### 2.7. Single-storey pole sheds and hay barns in rural zones



Legally required professional:

**Licensed Building Practitioner**

There is no restriction on the type of material used, however, additional professional advice may be needed when using construction materials or methods that the LBP is unfamiliar with.

To use this exemption, an owner must engage a Licensed Building Practitioner (LBP) to design, build and/or supervise the build of the hay barn or pole shed, as long as the net floor area does not exceed 110 square metres and the building work is carried out in accordance with the design.

Owners are encouraged to seek LBPs with the right competence for this work, as this provides the best assurance.

The design work is best carried out by an LBP holding a Design licence. The construction work is best carried out by an LBP in one of the following licensing classes, as may be relevant to the building work planned to be undertaken:

- Bricklaying and blocklaying
- Carpentry
- External plastering
- Foundations
- Roofing

Refer to the Who can undertake exempt work section on page 11 for more information about licensed building practitioners.



You should also check the applicable public register for any registered professional you engage (for example, a Chartered Professional Engineer) before you engage them to carry out work under this exemption.

If supervision is being provided by a licensed building practitioner under this exemption, that supervision must align with the Practice Note issued for Supervision by LBPs, which can be found at [www.lbp.govt.nz](http://www.lbp.govt.nz).



## Examples

---



### What is exempt

---

1. A rural farm owner wants to erect a hay barn with a net floor area of 80 square metres and with a maximum height of 3.6 metres. The proposed barn will be located 5 metres from the existing farm house. The site is a high wind zone. As the owners have contracted a licensed building practitioner to design, construct and/or supervise the building work, a building consent is not required.



### What needs consent

---

1. An owner of a farm in a rural zone wants to build a pole shed with a net floor area of 135 square metres. A building consent is required because the net floor area exceeds 110 square metres.

---

2. A farm owner wants to build a 95 square metre hay barn on their rural property. The barn roof has an unsupported span of 7.5 metres, which exceeds the 6 metre maximum span allowed under this exemption and therefore requires a building consent.

---

3. An owner of a farm in a rural zone wants to build a pole shed with a net floor area of 100 square metres to store small agricultural equipment. The building site is in an extra high wind zone. A building consent is required because the wind zone exceeds a "high" rating.

---

4. An owner of a farm in a rural zone wants to build a pole shed with a net floor area of 100 square metres to store some agrichemical, solvents or similar products which meet the hazardous classification criteria according to the Health and Safety at Work (Hazardous Substances) Regulations 2017. A building consent is required because the hazardous substances can create significant risk and are outside the scope of this exemption.



## What the law says

### Schedule 1 of the Building Act 2004

#### 4A. Single-storey pole sheds and hay barns in rural zones

1. Building work in connection with a pole shed or hay barn in a rural zone if—
  - (a). any design or construction work is carried out or supervised by a Licensed Building Practitioner; and
  - (b). the building—
    - (i). is not more than 1 storey (being a floor level of up to 1 metre above the supporting ground and a height of up to 4 metres above the floor level); and
    - (ii). does not exceed 110 square metres in floor area; and
    - (iii). is not accessible by the public; and
    - (iv). is not used to store hazardous substances within the meaning of that term in regulation 4 of the Health and Safety at Work (Hazardous Substances) Regulations 2017; and
  - (c). the maximum unsupported roof span in any direction does not exceed 6 metres; and
  - (d). either—
    - (i). the design wind speeds do not exceed 44 metres per second (calculated using Verification Method B1/VM1); or
    - (ii). the building is located in a wind zone no greater than high (as defined in Acceptable Solution B1/AS1).
2. However, subclause (1) does not include any building work in connection with a building that is closer than the measure of its own height to any residential building, public road, railway, or legal boundary.

## 2. Detached, standalone buildings

### 2.8. Repair or replacement of outbuilding



This exemption provides for the repair or replacement of existing outbuildings (as classified under Building Code clause A1 – Classified uses) that are not intended for human habitation. These include buildings such as carports, garages, greenhouses, machinery rooms, sheds, private swimming pools and farm buildings.

**i** Always check with your council to ensure your proposed building work complies with any district planning rules (eg maximum site coverage, yard/setback requirements, daylight access planes or permitted activities).

Your proposed carport may require a resource consent or deemed permitted boundary activity\* notice; it is important that you obtain one before starting any building work.

If you are building close to a boundary, the Building Code could require additional protection from fire; particularly to prevent fire spread to neighbouring property.

\*The deemed permitted activities are a 2017 RMA innovation:

<https://www.mfe.govt.nz/publications/rma/technical-guide-deemed-permitted-activities>

## Examples

---



### What is exempt

---

1. A timber weatherboard garage wall is severely damaged in an earthquake. The owner decides to replace the garage wall in the same position using pre-painted, profiled metal cladding.

---

2. A farmer decides to replace an old corrugated iron clad storage shed with a new shed in the same position and of the same size. The new shed will have a long-run steel roof and timber weatherboard wall cladding.

---

3. The owner of an old concrete block garage, which has part of its roof missing, decides to demolish it. They replace it in the same position with a new, prefabricated timber-framed garage with pre-finished steel roof and wall claddings.

---

4. An elderly couple decide to downsize their deteriorating double garage and replace it with a new single garage. This will occupy part of the footprint of the existing garage.



### What needs consent

---

1. The owner of a commercial garage decides to replace an old wooden garage, which is 50 square metres in size, with a new 65 square metre galvanised steel garage. Since the new garage is larger than the original, a building consent is required.

---

2. A farmer plans to replace an old farm shed by relocating part of it to the other side of their property and adding a new extension to it. As the farmer is not planning to rebuild in the same locality as the existing farm shed, a building consent is required (however, may be exempt with the pole shed exemptions 4A or 49 (sections 2.7. or 2.6.)).

---

3. A council proposes to replace an existing masonry public toilet block. Although the definition of outbuilding under the Building Code includes public toilets, a building consent is required. This is because condition (d) of this exemption does not allow the outbuilding to be open to, or used by, members of the public.

---

4. The owner of an earthquake-damaged carport proposes to replace it with a garage on the same footprint. As the proposed garage is not a comparable outbuilding, a building consent is required (however may be exempt with the 30 square metre single-storey detached building exemptions 3B or 43 (sections 2.4. or 2.3.)).



## What the law says

### Schedule 1 of the Building Act 2004

#### 7. Repair or replacement of outbuilding

1. The repair or replacement of all or part of an outbuilding if:
  - (a). the repair or replacement is made within the same footprint area that the outbuilding or the original outbuilding (as the case may be) occupied; and
  - (b). in the case of any replacement, the replacement is made with a comparable outbuilding or part of an outbuilding; and
  - (c). the outbuilding is a detached building that is not more than 1 storey; and
  - (d). the outbuilding is not intended to be open to, or used by, members of the public.

## 2. Detached, standalone buildings

---

### 2.9. Demolition of detached building



This exemption allows for the full demolition of all detached buildings up to three storeys high. However, partial demolition is not exempt from building consent, other than as permitted by exemption 1.4. If you are considering demolishing an existing building under this exemption, we recommend that you also consider the following:

- contacting the relevant service authorities to advise them of the extent of your work and discuss requirements regarding the termination of existing services such as electricity, gas, drainage, water, transport, telecommunications, cable television and any other services that may be affected
- handling and disposing of hazardous building materials
- controlling silt runoff, excess noise and dust generated by the demolition work, and
- securing the site (eg with a temporary fence or hoardings) to restrict public access to the area and avoid injury to members of the public.

**i** As a building owner, you should also check council requirements for the repair and reinstatement of any damage to the road reserve.

We recommend that you use skilled and professional building practitioners for major demolition work.

No demolition work should be undertaken on heritage or character buildings without first checking with your local council for its approval.

## Examples

---



### What is exempt

---

1. Following an earthquake, the owner decides to demolish their severely damaged 2 storey, detached family home.
2. The new owner of an old wooden single storey, detached holiday home plans to demolish it to make way for their new dream holiday home.



### What needs consent

---

1. Following a fire, a shop owner decides to demolish their damaged shop which is attached to another building (ie it is semi-detached) that is not damaged.  
A building consent is required because the building is not detached.
2. To make way for a new apartment block, the owner of a 4 storey commercial building intends to demolish it. A building consent is required because the building is more than 3 storeys.



### What the law says

#### Schedule 1 of the Building Act 2004

---

#### 30. Demolition of detached building

---

The complete demolition of a building that is detached and is not more than 3 storeys.





## 3. Windows, doors and walls

---

This section includes building work for windows, internal walls, internal and external doorways, internal linings and finishes, and internal doorway alteration for accessibility reasons.

The table below shows the exemptions included in this section and the professional you will need to approach for advice as needed.

Description*	Is an authorised professional legally required?	Who can provide professional advice?
3.1. Windows and exterior doorways in existing dwellings and outbuildings	No	Licensed Building Practitioner
3.2. Alteration to entrance or internal doorway to facilitate access for persons with disabilities	No	Licensed Building Practitioner
3.3. Internal walls and doorways in existing building	No	Licensed Building Practitioner
3.4. Internal linings and finishes in an existing dwelling	No	Licensed Building Practitioner

\* Owners must look at the relevant section of guidance to identify under which detailed conditions the building work qualifies for the exemption.

## 3. Windows, doors and walls

---

### 3.1. Windows and exterior doorways in existing dwellings and outbuildings



This exemption allows you to carry out any building work in connection with a window (including a roof window, whether it is fixed or opening) or an exterior doorway without needing a building consent where it is an existing dwelling or outbuilding. That is as long as the original doorway or window has not failed prematurely and replacing it will not modify or affect any specified system, such as sprinklers or fire alarms.

If you are replacing a window, roof window or door, it is important to consider whether it originally met the durability requirements of the Building Code. In most cases, doors and windows in an external wall are required to last at least 15 years. Most windows and doors should achieve this requirement with regular maintenance.

If the door or window is older than 15 years and you are replacing it because it has rotted out, then this work will not require a building consent.

However, if you are replacing a window, roof window or door that has been installed within the last 15 years and it has failed (eg it has rotted out), this work will require a building consent. This recognises that replacing a window or door that has failed its durability requirements with a similar window or door could result in the replacement also failing.

 All new building work must comply with the Building Code, including the structural performance requirements. Also note that, on completion of the building work, the altered building must comply with the Building Code to at least the same extent as it did before the building work was undertaken, unless it already exceeded the code.

If you are considering building work that is close to or involves potentially load-bearing walls, it is important to get professional advice from a Chartered Professional Engineer, Registered Architect, Building Consultant or Registered Building Surveyor.

Any changes or additions to doors or windows where the building forms part of the compliant pool barrier, must comply with the Building Act 2004.

## Examples

---



### What is exempt

---

1. A builder installs a roof window to an upper level apartment of a 2 storey multi-unit dwelling which will go between the existing roof trusses without altering any specified systems.
2. Following earthquake damage, a builder decides to install a bi-fold door to replace a pair of French doors leading from the ground floor dining room of a 2 storey dwelling. As the wall opening for the new joinery is wider than the existing opening, they need to install a new lintel to span the opening.
3. To gain more sunlight, a home owner decides to install a window in an external fire-rated bedroom wall which contains no other openings. As the window will be less than 1 metre from the boundary, the owner instructs the builder to install a fire-rated window to meet the Building Code requirements.



### What needs consent

---

1. A window installed in an existing outbuilding six years ago needs to be replaced because of a rotten timber window frame. Replacing this window requires a building consent because it has failed its 15 year durability requirement.
2. The owner of a commercial building wants to install a roof window into an existing roof and ceiling to a top floor office. As this building is not a dwelling or outbuilding, and as the roof window installation will affect the existing sprinkler system, a building consent is required.



### What the law says

#### Schedule 1 of the Building Act 2004

#### 8. Windows and exterior doorways in existing dwellings and outbuildings

Building work in connection with a window (including a roof window) or an exterior doorway in an existing dwelling that is not more than 2 storeys or in an existing outbuilding that is not more than 2 storeys, except:

- (a) in the case of replacement, if the window or doorway being replaced has failed to satisfy the provisions of the Building Code for durability, for example, through a failure to comply with the external moisture requirements of the Building Code; or
- (b) if the building work modifies or affects any specified system.

## 3. Windows, doors and walls

### 3.2. Alteration to existing entrance or internal doorway to facilitate access for persons with disabilities



This exemption enables you to alter existing residential dwellings to improve access for people with disabilities. Some common examples of this are modifying doorways to allow better wheelchair access and installing access ramps. For the purpose of this exemption, 'semi-detached dwellings' includes row or terraced housing but excludes multi-unit dwellings where one unit is above another.

This exemption does not cover construction of accessible or wet area showers.

New door openings are also outside its scope but may be covered under exemption 8 (Section 3.1. Windows and exterior doorways in existing dwellings and outbuildings).



If you are constructing a ramp or platform as part of this building work, you will need to install a safety barrier at any point where there is a fall of 1 metre or more, as required by Building Code clause F4 – Safety from falling.

## Examples

---



### What is exempt

---

1. An existing entry to a dwelling has a door with a window on either side of it, both within an aluminium frame. The entire aluminium frame can be removed and replaced with a wider door and a single window to allow better access.

---

2. A dwelling's existing internal doorway needs to be widened to improve accessibility. The door is located in a wall that is load-bearing and contains a bracing element. The opening can be widened without needing a building consent.

---

3. A home owner builds a ramp to provide access to a dwelling. At its highest point the ramp is 1.8 metres above ground level. Although a building consent is not required, they will have to install a safety barrier where there is a fall of 1 metre or more.



### What needs consent

---

1. An owner wants to create a new external door opening to improve access to a dwelling. This is outside the scope of this exemption as it is not a modification of an existing door. However, it may be exempt under exemption 3.1. (windows and exterior doorways in existing dwellings and outbuildings).

---

2. A building owner wants to construct a new door through an internal bracing wall. This will require a building consent as the proposed building work is not a modification of an existing door.



### What the law says

---

#### Schedule 1 of the Building Act 2004

---

9. **Alteration to existing entrance or internal doorway to facilitate access for persons with disabilities**
- 

Building work in connection with an existing entrance or internal doorway of a detached or semi-detached dwelling to improve access for persons with disabilities.

## 3. Windows, doors and walls

---

### 3.3. Internal walls and doorways in existing building



This exemption allows you to alter, remove or construct certain internal walls and doorways.

However, your proposed building work must not relate to a wall that is:

- load-bearing
- a bracing element
- a firewall
- a masonry wall, that is made of units of material such as brick, burnt clay, concrete or stone laid to a bond in and joined together with mortar.

Internal walls often contain bracing elements, so altering or removing these walls could adversely affect the building's structural performance. Some internal walls are also load-bearing, so altering or removing these may reduce a building's compliance with the Building Code's structural performance requirements. Therefore, such walls are not covered by this exemption.

Building work relating to masonry walls is also outside the scope of this exemption. Masonry walls are heavy, and the consequences of their collapse if they are not adequately supported are greater than for timber-framed walls.

 All new building work must comply with the Building Code, including with its structural performance requirements. Also note that, on completion of the building work, the altered building must comply with the Building Code to at least the same extent as it did before the building work was undertaken.

If you are considering building work that is close to or involves potentially load-bearing walls, it is important to get professional advice from an expert, such as a Chartered Professional Engineer, Registered Architect, Building Consultant or Registered Building Surveyor.

## Examples

---



### What is exempt

---

1. An owner of a residential dwelling wishes to remove a section of internal timber-framed wall to make room for a new kitchen installation. After discussing this with a building practitioner, the owner is satisfied that the section of wall is not load-bearing and is not a bracing element. This building work does not require a building consent.

---

2. An owner of a commercial property wishes to build a metal-framed internal wall to provide privacy in a reception area. As the wall is not load-bearing, has no bracing element and is not a firewall, a building consent is not required.

---

3. The owner of a dwelling wishes to remove a non load-bearing wall between the kitchen and laundry to provide for an enlarged kitchen space. The timber-framed wall has no bracing elements and therefore the building work does not require a building consent.



### What needs consent

---

1. A hotel owner wants to cut a new opening in an existing masonry wall to create an open-plan lobby and reception area. The owner seeks guidance from their local council and an architect. Historic plans are reviewed and the architect discovers that the wall is load-bearing. As the proposed alteration affects a masonry, load-bearing wall, a building consent is required.

---

2. An owner of a building wishes to install a door in an internal wall that is not load-bearing. However, the wall is made out of reinforced brick so a building consent is required.



3. The owner of a dwelling wishes to remove part of an internal metal-framed wall between the hallway and kitchen. They seek advice from a licensed building practitioner who, after a quick visit to the house, informs them that the wall is load-bearing. Therefore, the removal would require a building consent.



### What the law says

#### Schedule 1 of the Building Act 2004

##### 11. Internal walls and doorways in existing building

Building work in connection with an internal wall (including an internal doorway) in any existing building unless the wall is:

- (a). load-bearing; or
- (b). a bracing element; or
- (c). a fire separation wall (also known as a firewall); or
- (d). part of a specified system; or
- (e). made of units of material (such as brick, burnt clay, concrete, or stone) laid to a bond in and joined together with mortar.

## 3. Windows, doors and walls

---

### 3.4. Internal linings and finishes in existing dwelling



This exemption allows you to replace or alter any or all of the linings and finishes of walls, ceilings or floors of an existing dwelling (whether single or multi-unit). Unlike exemption 1 (general repair, maintenance, and replacement), this exemption does not require you to use comparable materials.

As wall and ceiling linings often provide bracing and fire resistance, we recommend you seek advice from an appropriately qualified building practitioner before carrying out any such work.

Wet area or level entry showers are generally outside the scope of this exemption.

[Wet area showers need building consent on building.govt.nz](http://building.govt.nz)



If you are not sure whether proposed building work could affect Building Code compliance including with fire safety, structural performance and internal moisture requirements, seek the advice of a suitably qualified person.

## Examples

---



### What is exempt

---

1. Replacing the ceiling lining (which is a bracing diaphragm) in an existing semi-detached dwelling because of impact damage, with a new bracing diaphragm.

---

2. Replacing earthquake-damaged lathe and plaster wall linings in an existing detached house with wood panelling to dado height over full height plasterboard sheets.

---

3. Replacing a dwelling's tongue and groove floor boards with particle-board sheets.

---

4. Replacing a dwelling's plasterboard internal linings with new plasterboard.



### What needs consent

---

1. Replacing internal linings and finishes in commercial and industrial buildings, unless the proposed work is covered by another exemption.

---

2. Installing a tiled wet area shower in an existing dwelling will require a building consent. This is because the construction of a wet area shower generally includes critical building work, such as waterproof membranes and structural modifications to the flooring system.



### What the law says

---

#### Schedule 1 of the Building Act 2004

---

#### 12. Internal linings and finishes in existing dwelling

---

Building work in connection with any internal linings or finishes of any wall, ceiling, or floor of an existing dwelling.



## 4. Plumbing and drainage

This section includes all exempt plumbing and drainage work such as the repair, maintenance and replacement of sanitary plumbing, drainage, and existing water heaters.

The table below shows the exemptions included in this section and the professional you will need to hire.

Description*	Is an authorised professional legally required?	Who can provide professional advice?
4.1. Repair, maintenance, and replacement of sanitary plumbing and drainage	Yes	All sanitary plumbing work must be carried out by an authorised plumber.  All drainlaying work must be carried out by an authorised drainlayer.
4.2. Drainage access points	Yes	All drainlaying work must be carried out by an authorised drainlayer.
4.3. Repair and maintenance of existing water heater	Yes	All sanitary plumbing work must be carried out by an authorised plumber.
4.4. Replacement of open-vented water storage heater connected to supplementary heat exchanger	Yes	All sanitary plumbing work must be carried out by an authorised plumber.
4.5. Replacement or repositioning of water heater connected to controlled heat source	Yes	All sanitary plumbing work must be carried out by an authorised plumber.
4.6. Minor alteration to drains	Yes	All drainlaying work must be carried out by an authorised drainlayer.
4.7. Alteration to existing sanitary plumbing (excluding water heaters)	Yes	All sanitary plumbing work must be carried out by an authorised plumber.

\*Owners must look at the relevant section of guidance to identify under which detailed conditions the building work qualifies for the exemption.

[Search the register of authorised plumbers, gasfitters and drainlayers](#)

## 4. Plumbing and drainage

---

### 4.1. Repair, maintenance, and replacement of sanitary plumbing and drainage



Legally required professional:

Plumber

This exemption enables a range of work relating to the repair, maintenance and replacement of sanitary plumbing or drainage to be done without a building consent - as long as it is carried out by an authorised person.

For repairs and maintenance, comparable materials must be used. For replacement work, comparable components or assemblies can be used providing the replacement is in the same position.

#### Examples

---



#### What is exempt

---

1. A home owner wants to replace an existing vanity with a new one. A building consent is not required as they are replacing an existing sanitary fixture with another comparable fixture in the same position.
2. Repairing a septic tank effluent disposal system.
3. A section of glazed earthenware foul water drain is damaged in an earthquake and requires replacement. A drainlayer proposes to replace the damaged section with uPVC. This does not require a consent as it is considered to be a comparable component.



### What needs consent

1. A commercial building owner needs to replace a backflow preventer (reduced pressure zone device). As an automatic backflow preventer is a specified system and the work involves a complete replacement, a building consent is required.
2. Replacing a leaking potable water supply pipe which has failed to meet its Building Code durability requirements.



### What the law says

#### Schedule 1 of the Building Act 2004

#### 32. Repair, maintenance, and replacement<sup>MBIE</sup>

1. The repair and maintenance of any sanitary plumbing and drainage in or associated with a building, provided that comparable materials are used.
2. Replacement of sanitary plumbing and drainage in or associated with a building, provided that:
  - (a). a comparable component or assembly is used; and
  - (b). the replacement is in the same position.
3. However, subclauses (1) and (2) do not include the following building work:
  - (a). complete or substantial replacement of a specified system; or
  - (b). repair or replacement (other than maintenance) of any component or assembly that has failed to satisfy the provisions of the Building Code for durability, for example, through a failure to comply with the external moisture requirements of the Building Code; or
  - (c). repair or replacement of any water heater (unless permitted under clauses 36 to 38 (sections 4.3., 4.4. and 4.5.)).

## 4. Plumbing and drainage

---

### 4.2. Drainage access points



Legally required professional:

**Drainlayer**

This exemption covers work to drains via a purpose-made access point and carried out by an authorised person.



## Examples

---



### What is exempt

---

1. A drain is blocked by a back-up of waste material within the drainage system after a child flushed a hand towel down the toilet. The building owner fixes the problem by opening a purpose-made access point, removing the towel, clearing the blockage and reinstating the access point.



### What needs consent

---

1. A multi-storey apartment building has a blocked drain and no access points can be found. The owner is informed that several access chambers will need to be installed for future access. As this involves more than opening and reinstating access points, and since it is not considered minor drain alterations, a building consent is required.



### What the law says

#### Schedule 1 of the Building Act 2004

---

#### 33. Drainage access points

---

The opening and reinstatement of any purpose-made access point within a drainage system that is not a NUO system or part of a NUO system.

## 4. Plumbing and drainage

---

### 4.3. Repair and maintenance of existing water heater



Legally required professional:

Plumber

This exemption enables an authorised person to repair and maintain water heaters associated with buildings. Any repair work must use comparable materials, comparable components or a comparable assembly.

To replace or reposition an existing water heater refer to exemptions 37 and 38 (sections 4.4. and 4.5.).

## Examples

---



### What is exempt

---

1. Repairing a leaking open-vented water storage heater.

---

2. Repairing a valve-vented water storage heater.

---

3. Replacing sacrificial anodes.

---

4. Repairing valves associated with water heaters.

---

5. Repair or maintaining solar water heating system collectors.



### What needs consent

---

1. While repairing their existing (open-vented) storage water heater, a homeowner decides to replace the existing wood burner and wetback system. As replacing the wood burner and wetback is not considered to be repairs or maintenance, the building work requires a consent.



### What the law says

---

#### Schedule 1 of the Building Act 2004

---

#### 36. Repair and maintenance of existing water heater

---

The repair or maintenance of any existing water heater using comparable materials, comparable components, or a comparable assembly.

## 4. Plumbing and drainage

---

### 4.4. Replacement of open-vented water storage heater connected to supplementary heat exchanger



Legally required professional:

Plumber

This exemption enables an authorised person to replace open-vented water storage heaters associated with existing supplementary heat exchangers such as wetbacks or solar collection panels. The replacement water storage heater must be comparable and in the same position.

#### Examples

---



#### What is exempt

---

1. A home owner wants to replace an open-vented water storage heater with a comparable open-vented water storage heater in the same position, using the same pipe work and connected to solar water heating collectors.
2. A building owner wants to replace an open-vented water storage heater with another open-vented water storage heater in the same position, using the same pipe work and connected to a solid-fuel heater wetback.

3. A building owner wants to replace an external water storage heater with a heat pump water storage heater (eg replacing an open-vented water storage heater with another open-vented storage heater) in the same position, using the same pipe work and connected to a heat pump.



### What needs consent

1. Replacing an open-vented water storage heater with a valve-vented water storage heater. As the water-storage heaters are not comparable, a building consent will be required.
2. Replacing and relocating an open-vented water storage heater and reconnecting it to the existing wood burner with a wetback. As the replaced water storage heater will not be fixed in the same position, a building consent is required.
3. Replacing an open-vented water storage heater and adding a wetback where there was no wetback before.
4. Adding a roof-mounted solar collection panel which will be connected to an existing open-vented water storage heater.



### What the law says

#### Schedule 1 of the Building Act 2004

#### 37. Replacement of open-vented water storage heater connected to supplementary heat exchanger

The replacement of any water-storage heater connected to a solid-fuel heater or other supplementary heat exchanger if the replacement:

- (a). is a comparable open-vented water storage heater; and
- (b). is fixed in the same position, and uses the same pipework, as the replaced water storage heater.

## 4. Plumbing and drainage

---

### 4.5. Replacement or repositioning of water heater connected to controlled heat source



Legally required professional:

Plumber

This exemption enables an authorised person to replace and/or reposition an existing water heater of any type, as long as all the heat sources of the replaced or repositioned water heater are controlled. This exemption will not apply if a water heater has a heat source that is not controlled, such as a wetback connected to a solid-fuel heating appliance, or a solar thermosiphon system.

A controlled heat source has controls or devices that ensure the water temperature in the storage tank is no greater than 90 degrees celcius.

**i** If the proposed scope of the building work is outside the scope of this or any other exemption (eg adding solar water heating collectors to an existing water storage heater, which has provision for solar connection and is not being replaced or repositioned), we suggest that you consider applying to the council for a discretionary exemption. The council can then decide whether or not it will require a building consent. Before doing this, we recommend that you talk to the council to gauge whether or not it is prepared to exercise its discretion under exemption 2 on your project. See more information in territorial and regional authority discretionary exemptions.

Any repair or maintenance of part of a water heater (which may include the replacement of a component of the water heating system) falls outside the scope of this exemption.

Exemption 4.3. deals with repairs or maintenance of part of a water heater.

Replacing a hot water cylinder which is connected to an existing wetback falls outside this exemption (refer to exemption 4.4. for open-vented systems).

## Examples

---



### What is exempt

---

#### Water storage heaters

---

1. Replacing an existing valve-vented water storage heater with a thermostatically controlled valve-vented water storage heater, for example electric to electric, gas to gas, electric to gas, or gas to electric.

---

2. Repositioning an existing valve-vented water storage heater that has a controlled heat source.

---

3. Replacing an existing open-vented water storage heater with a valve-vented water storage heater that has a controlled heat source.

---

4. Repositioning an open-vented water storage heater, when in the new position it is connected to a controlled heat source.

#### Solar water storage heaters

---

5. Replacing and/or repositioning an existing water storage heating system comprising a water storage heater that includes controlled solar water heating collectors.

---

6. Replacing or repositioning an existing electric or gas water storage heater with a water storage heater system that includes controlled solar collectors.

#### Heat pump water storage heaters

---

7. Replacing a water storage heater with a heat pump water storage heater.

---

8. Replacing and repositioning an internal water storage heater with an external heat pump water storage heater.

---

9. Replacing an external water storage heater with an external heat pump water storage heater.

### Instantaneous water heaters

---

10. Replacing or repositioning an instantaneous water heater that is thermostatically controlled.
- 
11. Replacing an existing storage water heater with a gas instantaneous water heater.



### What needs consent

---

1. Adding a solar collector to an existing water storage heater (even if the existing water storage heater has provision for solar connection). A building consent is required because this exemption only covers replacement or repositioning of existing water heaters.
- 
2. Adding a wetback (not a replacement wetback) connected to a water storage heater. A building consent is required because this exemption only covers replacement or repositioning of existing water heaters. Also the wetback is an uncontrolled heat source.
- 
3. Adding a split heat pump (not a replacement split heat pump) to an existing water storage heater. A building consent is required because this exemption only covers replacement or repositioning of existing water heaters.



### What the law says

---

#### Schedule 1 of the Building Act 2004

---

38. Replacement or repositioning of water heater that is connected to, or incorporates, controlled heat source
- 

The replacement of any water heater (including the repositioning of an existing water heater) if the replacement water heater is connected to, or incorporates, a controlled heat source or, if connected to or incorporating more than 1 heat source, 2 or more heat sources all of which are controlled.



## 4. Plumbing and drainage

---

### 4.6. Minor alteration to drains



Legally required professional:

Drainlayer

This exemption only relates to dwellings and enables an authorised person to alter existing private drainage without needing a building consent. This sort of building work usually occurs during alterations to existing bathrooms, kitchens, laundries or toilets.

New connections to public drainage are specifically excluded from this exemption.

#### Examples

---



#### What is exempt

---

1. A homeowner instructs the plumber to relocate the kitchen sink to an adjacent wall. The existing gully trap servicing the kitchen needs to be shifted a short distance to receive the discharge from the repositioned sink wastepipe.
2. A toilet pan has been repositioned in an existing dwelling's bathroom and is reconnected 1 metre downstream from the previous drain connection.
3. Installing a new access or rodding point for unblocking drains.

- 
4. Capping a branch drain following the removal of sanitary fixtures from an outbuilding associated with a dwelling.
- 
5. A NUO has provided a new sewer lateral connection at the boundary of an existing dwelling and capped the previous lateral. The owner's drainlayer reroutes a 2 metre length of drain to reconnect to the new NUO lateral.



### What needs consent

---

1. A dwelling's branch drain is intended to be extended by 16 metres. As the branch drain will exceed 10 metres, it comes under requirement for venting under Building Code clause G13 – Foul water. As the length and venting requirements of the drain are more than a minor alteration, a building consent is required.
- 
2. A motel owner plans to reconfigure their laundry, which includes adding another laundry tub. As a consequence, the main drain will need to be extended by several metres around the perimeter of the building. Although the drain extension is minor, the installation of an additional laundry tub is outside the scope of this exemption. Furthermore, as the building is not a dwelling, it is not covered by this exemption and a building consent is required.
- 
3. A drainlayer contracted by a building owner proposes to reposition a dwelling's drain connection into the NUO drain which traverses the property and is covered by an easement on the title. A building consent will be required as this is a new connection to a NUO drain.



### What the law says

---

#### Schedule 1 of the Building Act 2004

---

#### 34. Minor alteration to drains

---

1. Alteration to drains for a dwelling if the alteration is of a minor nature, for example, shifting a gully trap.
2. Subclause (1) does not include making any new connection to a service provided by a network utility operator.

## 4. Plumbing and drainage

### 4.7. Alteration to existing sanitary plumbing (excluding water heaters)



Legally required professional:

Plumber

This exemption enables an authorised person to carry out alterations to sanitary plumbing. However, this is only as long as these alterations do not increase the number of sanitary fixtures within any existing building and they do not modify or affect any specified system.

**i** If you are not sure if this exemption applies to your proposed building work, we recommend that either you seek a discretionary exemption from the council or apply for a building consent rather than risk applying it incorrectly.

Alterations to water heaters are specifically excluded from this exemption. However, there is still some building work in relation to water heaters which does not require a building consent: this is covered in the next three exemptions (36, 37 and 38 (sections 4.3., 4.4. and 4.5.)).

 Any plumbing work under this exemption must be carried out by an authorised person, otherwise it is not exempt work.

Where sanitary plumbing work could adversely affect the structural performance of structural elements such as floor joists or wall framing, the work may require a building consent. If you are not sure, we recommend seeking professional advice first from a licensed building practitioner, chartered professional engineer, registered architect, building consultant, registered building surveyor or accredited building consent authority.

## Examples

---



### What is exempt

---

1. Repositioning or replacing sanitary fixtures such as a bath, bidet, wash hand basin, shower or toilet pan within an existing bathroom in a dwelling.

---

2. Moving a toilet pan from a toilet compartment into an adjacent existing bathroom in a dwelling.

---

3. A home owner proposes to remodel an existing kitchen within the same space, leaving the kitchen sink in the same position.

---

4. An existing laundry tub in a dwelling will be moved to a new location within the adjacent kitchen.

---

5. Relocating, removing or shifting an existing hose tap.

---

6. Removing a bath with a shower over it, and replacing this with a new proprietary shower enclosure and a new bath within the existing bathroom space. As the existing bath/shower arrangement has two sanitary fixtures, each fixture can be replaced and relocated without the need for a building consent.



### What needs consent

---

1. Installing a tiled wet area shower requires a building consent. This is because it involves critical building work that is not sanitary plumbing, such as carpentry and installing waterproof membranes.

---

2. Moving a vanity, bath and shower within an apartment of a multi-level building. This building work involves new penetrations through a fire separation, which is a specified system.

3. An ensuite is proposed which includes the addition of a shower, hand basin and toilet. These sanitary fixtures are additional to those that already exist in the building, so a building consent is required.
4. A restaurant owner decides to increase the number of sanitary fixtures to allow for increased customer capacity. This work will require a building consent.
5. Installing a new testable backflow prevention device in a building that is not a dwelling. As this device is a specified system, a building consent is required and the compliance schedule will also need to be amended.



### What the law says

#### Schedule 1 of the Building Act 2004

#### 35. Alteration to existing sanitary plumbing (excluding water heaters)

1. Alteration to existing sanitary plumbing in a building, provided that:
  - (a). the total number of sanitary fixtures in the building is not increased by the alteration; and
  - (b). the alteration does not modify or affect any specified system.
2. Subclause (1) does not include an alteration to a water heater.



## 5. Insulation and moisture barriers

---

This section includes internal wall insulation and ground moisture barriers.

The table below shows the exemptions included in this section and the professional you may need to engage.

Description	Is an authorised professional legally required?	Who can provide professional advice?
5.1. Thermal insulation	No	Competent insulation installers or Licensed Building Practitioner
5.2. Ground moisture barrier	No	Competent insulation installers or Licensed Building Practitioner

## 5. Insulation and moisture barriers

---

### 5.1. Thermal insulation



This exemption does not cover the installation of thermal insulation in an external wall of a building, as this may have weathertightness implications. Installing insulation in internal walls that provide fire separation is also outside its scope, as this could adversely affect the building's fire safety properties.



## Examples

---



### What is exempt

---

1. A house is being retrofitted with insulation to the sub-floor and ceiling spaces.
2. An existing apartment building is being retrofitted with fibreglass insulation to the internal, non fire-rated walls for additional thermal and noise control.



### What needs consent

---

1. The external walls to a house are to be injected with expanding insulating foam.
2. A fire-rated tenancy wall to an apartment is to be retrofitted with thermal insulation.



### What the law says

---

#### Schedule 1 of the Building Act 2004

---

#### 13. Thermal insulation

---

1. Building work in connection with the installation of thermal insulation in an existing building other than in:
  - (a). an external wall of the building; or
  - (b). an internal wall of the building that is a fire separation wall (also known as a firewall).

## 5. Insulation and moisture barriers

### 5.2. Ground moisture barrier



This exemption reflects that the installation of ground moisture barriers is building work with a low risk of causing danger to people or damage to other buildings.



#### Amended July 2019

Clause 13A of Schedule 1 was inserted, as from 1 July 2019, by the Building (Exempt Building Work) Order 2019.



The Residential Tenancies (Healthy Homes Standards) Regulations 2019, which came into force on 1 July 2019, set minimum requirements for rental properties in relation to heating, insulation, ventilation, moisture ingress and drainage, and draught-stopping.

This includes a requirement that all residential rental premises with enclosed subfloor spaces must have ground moisture barriers installed in those spaces where reasonably practicable.

The regulations provide a transitional period to give landlords time to comply with the new standards:

- 1 July 2021 – From this date, private landlords must ensure that their rental properties comply within 90 days of any new tenancy
- 1 July 2021 – All boarding houses must comply
- 1 July 2023 – All Housing New Zealand and registered Community Housing Provider houses must comply
- 1 July 2024 – All rental homes must comply.

## Examples

---



### What is exempt

---

1. The subfloor space within an existing house is being retrofitted with a ground moisture barrier



### What needs consent

---

1. A ground moisture barrier is to be installed within the subfloor space of a new house under construction.



### What the law says

---

Schedule 1 of the Building Act 2004

---

#### 13A. Ground moisture barrier

---

Building work in connection with the installation in an existing building's subfloor space of a ground moisture barrier.



## 6. Porches, verandas and pergolas

---

This section includes construction of porches, verandas and pergolas, as well as closing existing verandas or patios.

The table below shows the exemptions included in this section and the professional you will need to hire.

Description	Is an authorised professional legally required?	Who can provide professional advice?
6.1. Porches and verandas up to 20 square metres	No	Licensed Building Practitioner
6.2. Porches and verandas exceeding 20 square metres in floor area but not exceeding 30 square metres	Yes	Chartered Professional Engineer
6.3. Porches and verandas exceeding 20 square metres in floor area but not exceeding 30 square metres	Yes	Licensed Building Practitioner or Registered Architect
6.4. Closing in existing veranda or patio	No	Licensed Building Practitioner or Registered Architect
6.5. Pergolas	No	Licensed Building Practitioner or Registered Architect

# Notes for porches and verandas

---

Sections 6.1-6.3 cover three separate exemptions for porches and verandas.

- Porches and verandas up to 20 square metres in size where a professional is not required to carry out the building work
- Porches and verandas up to 30 square metres, when the design is carried out or reviewed by a Chartered Professional Engineer, OR
- Porches and verandas to 30 square metres in size, when a Licensed Building Practitioner is to carry out or supervise design and construction. The design can also be carried out by a Registered Architect.

Porches and verandas are usually made from permanent materials and often extend over raised decks or patios.

Porches are roofed structures which project from the face of a building. They may have sides but they are open at the front. Porches are generally used to protect a building entrance and to provide shelter.

A veranda is typically a long porch and can extend along the full length, or even around more than one side, of a building.

## Before you begin your project, you need to consider the following:

---

### Stormwater

You need to consider the Building Code requirements regarding the disposal of stormwater from the roof of your building. You may need to seek professional guidance and seek approval from your council. All new drains must be laid by an Authorised Drainlayer.

### District planning

Always check with your local council to make sure your proposed building work does not have any district planning implications taking consideration of maximum site coverage, yard or setback requirements, daylight access planes or permitted activities. A resource consent may be required and it is important that this is obtained before starting any building work.

### Building close to boundaries

If you are building close to boundaries, you need to consider the Building Code requirements regarding protection from fire, particularly in relation to the external spread of fire to neighbouring property.

## 6. Porches, verandas and pergolas

### 6.1. Porches and verandas up to 20 square metres



This exemption allows for extending existing porches and verandas up to a total maximum of 20 square metres. Additional porches and verandas may be added but the maximum size must not exceed 20 square metres. They must also be located at the ground level. This exemption does not apply where a member of the public might have access to the areas covered by a porch or veranda.



If a homeowner intends to build a veranda or porch greater than 20 square metres but not exceeding 30 square metres on the ground floor, exemptions 17A or 46 (sections 6.3. or 6.2.) may apply.

## Examples

---



### What is exempt

---

1. A building owner wishes to remove an existing porch from the entry to a dwelling. The porch is 20 square metres in area.

---

2. A ground floor apartment owner wishes to increase the area of an existing veranda from 10 square metres to 20 square metres.

---

3. An owner of a multi-storey apartment building proposes to build a 15 square metres roofed structure with open sides to provide weather protection to the ground floor main entrance.



### What needs consent

---

1. An existing veranda measures 10 square metres and the owner wishes to increase its size to 35 square metres. The existing structure may remain, but because the additional work increases the size beyond 30 square metres, a building consent will be required.

---

2. The owners of a fourth floor flat wish to build a veranda. They will need to obtain a building consent because the veranda is not on the ground floor of the building.

---

3. A restaurant owner wants to build a 15 square metre veranda to create an outdoor eating area. This requires a building consent because this is an area accessible by the public.



### What the law says

---

#### Schedule 1 of the Building Act 2004

---

#### 17. Porches and verandas not exceeding 20 square metres in floor area

---

Building work in connection with a porch or a veranda that:

- (a). is on or attached to an existing building; and
- (b). is on the ground level of the building; and
- (c). does not exceed 20 square metres in floor area; and
- (d). does not overhang any area accessible by the public, including private areas with limited public access, for example, restaurants and bars.



## 6. Porches, verandas and pergolas

### 6.2. Porches and verandas exceeding 20 square metres in floor area but not exceeding 30 square metres



Legally required professional:

**Chartered Professional Engineer**

This exemption allows you to build or extend a deck or veranda up to 30 square metres, provided the design is carried out or reviewed by a Chartered Professional Engineer. The work must also be carried out in accordance with that design.

Before you begin, please read the notes for porches and verandas on page 110.



If a home owner intends to build a veranda or porch less than 20 square metres on the ground floor, exemption 17 (section 6.1.) may be applicable.

## Examples

---



### What is exempt

---

1. A building owner wishes to increase the size of an existing porch from the entry to a dwelling at ground level. The size of the porch (including the existing one) is 25 square metres. Provided that plans and specifications designed or reviewed by a Chartered Professional Engineer and the work is carried out in accordance with that design, the work does not need a consent.

---

2. A ground floor apartment owner wishes to increase the area of an existing veranda from 20 square metres to 30 square metres. The design is carried out or reviewed by a Chartered Professional Engineer and subsequently the work is carried out in accordance with that design.

---

3. A building owner wishes to increase the area of an existing veranda from 15 square metres to 30 square metres by buying pre-engineered kitset products. The design of this proprietary product has been signed off by a Chartered Professional Engineer and the construction of the veranda will be according to that design.



### What needs consent

---

1. The owners of a commercial building wish to build a veranda on the first floor level to cover an area of 25 square metres. A building consent is required as the proposed location is above the ground floor of the building.

---

2. A shop owner wants to build a 35 square metres veranda in a space without public access. This requires a building consent as the area exceeds 30 square metres.



### What the law says

#### Schedule 1 of the Building Act 2004

#### 46. Porches and verandas exceeding 20, but not exceeding 30, square metres in floor area

1. Building work in connection with a porch or a veranda that—
  - (a). is on or attached to an existing building; and
  - (b). is on the ground level of the building; and
  - (c). exceeds 20 square metres in floor area, but does not exceed 30 square metres; and
  - (d). does not overhang any area accessible by the public, including private areas with limited public access, for example, restaurants and bars.

This exemption also requires that the design of the building work has been carried out or reviewed by a Chartered Professional Engineer and the building work has been carried out in accordance with that design.

## 6. Porches, verandas and pergolas

---

### 6.3. Porches and verandas exceeding 20 square metres in floor area but not exceeding 30 square metres



Legally required professional:

**Licensed Building Practitioner**

This exemption covers porches and verandas between 20 and 30 square metres where the design and construction is carried out by a

Licensed Building Practitioner (LBP) and the work is carried out in accordance with that design. They must be located on the ground floor of the building. This exemption does not apply where a member of the public might have access to the areas covered by a porch or veranda.

Before you begin, please read the notes for porches and verandas on page 110.

Any design or construction work done using this exemption must be carried out or supervised by a Licensed Building Practitioner (LBP) or a Registered Architect. Building owners are encouraged to seek LBPs with the right competence for this work, as this provides the best assurance.

The design work is best carried out by a LBP holding a Design licence or a Registered Architect. The construction work is best carried out by an LBP in one of the following licensing classes, as may be relevant to the building work planned to be undertaken:

- Bricklaying and blocklaying
- Carpentry
- External plastering
- Foundations
- Roofing

Refer to the Who can undertake exempt work section on page 11 for more information about Licensed Building Practitioner.

 You should check and confirm the LBPs current licensing status and licensing history before you engage them to carry out work under this exemption.

If supervision is being applied by a Licensed Building Practitioner under this exemption, that supervision must align with the Practice Note issued for Supervision by LBPs, which can be found at [www.lbp.govt.nz](http://www.lbp.govt.nz).

If an owner intends to erect a porch or veranda less than 20 square metres on the ground floor, exemption 17 (section 6.1.) may be applicable.

## Examples

---



### What is exempt

---

1. A building owner wishes to increase the size of an existing porch from the entry to a dwelling at ground level. The size of the porch (including the existing one) will be 25 square metres and will not overhang any area generally accessible to the public. Provided that the design and construction is undertaken or supervised by a Licensed Building Practitioner and the work is carried out in accordance with that design, a building consent is not required.

---

2. A homeowner wishes to add a veranda of 30 square metres to their private property. Provided that the design and construction of the structure is undertaken or supervised by a Licensed Building Practitioner and the work is carried out in accordance with that design, a building consent is not required.



### What needs consent

---

1. The owners of a commercial building wish to build a veranda on the first floor level to cover an area of 25 square metres. A building consent is required as the proposed location is above the ground floor of the building.

---

2. A shop owner wants to build a 30 square metre veranda in a space without public access. To save money, the shop owner wants to do this work themselves, so they are unable to use this exemption as this exemption requires the use of a Licensed Building Practitioner.



## What the law says

### Schedule 1 of the Building Act 2004

#### 17A. Porches and verandas exceeding 20, but not exceeding 30, square metres in floor area

1. Building work in connection with a porch or a veranda if—
  - (a). any design or construction work is carried out or supervised by a Licensed Building Practitioner; and
  - (b). the porch or veranda—
    - (i). is on or attached to an existing building; and
    - (ii). is on the ground level of the building; and
    - (iii). exceeds 20 square metres in floor area, but does not exceed 30 square metres; and
    - (iv). does not overhang any area accessible by the public, including private areas with limited public access, for example, restaurants and bars.

## 6. Porches, verandas and pergolas

---

### 6.4. Closing in existing veranda or patio



This exemption allows you to close in an existing veranda, patio or similar structure in order to convert an area into an enclosed space (eg a conservatory).

The size of this enclosed space must not exceed 5 square metres.



## Examples

---



### What is exempt

---

1. A building owner has an existing patio measuring 4.5 square metres in area and wishes to fully enclose it with glazing.

---

2. An owner of a bay villa decides to partially enclose an existing veranda to have a 5 square metre sunroom off the living room. Glazed window joinery is installed on three sides to create the new space.



### What needs consent

---

1. A building owner wants to change an existing veranda into an enclosed conservatory. The veranda measures 15 square metres in total. As the area she wishes to enclose is greater than 5 square metres, they will need to obtain a building consent.



### What the law says

#### Schedule 1 of the Building Act 2004

---

#### 15. Closing in existing veranda or patio

---

1. Building work in connection with the closing in of an existing veranda, patio, or the like so as to provide an enclosed porch, conservatory, or the like with a floor area not exceeding 5 square metres.

## 6. Porches, verandas and pergolas

---

### 6.5. Pergolas



Pergolas are simple-framed and unroofed structures which are often used as garden features. For the purposes of this exemption, pergolas may either be attached to a building or freestanding. There is no limit on their size, but they must not be roofed.

## Examples

---



### What is exempt

---

1. An owner purchases a kitset for a 26 square metre, 2.4 metre high pergola.

---

2. A vineyard owner constructs a 100 square metre, 5 metre high pergola for wedding receptions.

---

3. A builder attaches a 10 square metre pergola to a dwelling. The pergola is over a deck which is accessed via French doors from the living room.

---

4. A council installs a 3 metre wide decorative pergola that runs the full length of a 250 metre long pathway in a public park.



### What needs consent

---

1. An owner wishes to alter a 32 square metre pergola attached to their house by fitting clear polycarbonate roofing material to the structure. As the pergola will be roofed, it will not be covered by this exemption. The addition of the roof will turn it into a veranda but, as its area is greater than 30 square metres, it will not be covered by exemptions 17, 17A or 46 (sections 6.1, 6.3 or 6.2) (porches and verandas) either and will require a building consent.

---

2. A garden centre wants to erect several pergolas covered in plastic sheeting to provide shelter for customers in the outside courtyard. The addition of the plastic covering to form a closed roof and walls means that the structures are no longer pergolas for the purpose of this exemption and a building consent will be required.



### What the law says

#### Schedule 1 of the Building Act 2004

---

#### 6. Pergolas

---

Building work in connection with a pergola.



## 7. Platforms, decks and bridges

---

This section includes building work for decks, platforms, bridges, boardwalks which will be accessible by the public. It also includes short-span bridges on private land, without public access.

The table below shows the exemptions included in this section and the professional you will need to hire.

Description*	Is an authorised professional legally required?	Who can provide professional advice?
7.1. Decks, platforms, bridges and boardwalks	No	Licensed Building Practitioner or Chartered Professional Engineer
7.2. Short-span bridges on private land	Yes	Chartered Professional Engineer

\*Owners must look at the relevant section of guidance to identify under which detailed conditions the building work qualifies for the exemption.

## 7. Platforms, decks and bridges

---

### 7.1. Decks, platforms, bridges, boardwalks, etc



A building consent is not required for work on decks, platforms, bridges, boardwalks and like structures where it is not possible to fall more than 1.5 metres.

Note that a safety barrier is still required under Building Code clause F4 – Safety from falling where there is a fall of 1 metre or more.

**i** Always check with your local council to ensure the proposed building work does not have any district planning implications, such as maximum site coverage, yard or setback requirements, daylight access planes and permitted activities. A resource consent may be required and it is important that you obtain this before starting any building work.

## Examples

---



### What is exempt

---

1. A low-level deck is constructed to create a level entry to a dwelling. The deck has a maximum height of 500 millimetres above ground level.

---

2. A building owner constructs a 50 square metre deck with a maximum height of 900 mm above ground and attached to two sides of a building. Even if the deck were to collapse, the fall would be less than 1.5 metres.

---

3. The owner of a resort intends to build a boardwalk across some rough ground to give guests access to an ornamental garden and play area. The highest point of the boardwalk is 1.5 metres above the ground. To prevent guests from falling off the boardwalk, a safety barrier is installed on both sides.



### What needs consent

---

1. A home owner wants to construct a platform in conjunction with other landscaping work. The landscaping work will result in a reduced ground level at the rear exit of the building. As the proposed platform will have a finished height above ground level of 1.7 metres, it will require a building consent. A safety barrier will also be required under Building Code clause F4 as there is a fall of 1 metre or more.

---

2. The owner of a multi-storey apartment complex intends to provide outdoor decks to the apartments on the upper levels. This work will require a building consent as it is possible for a person to fall more than 1.5 metres. (A safety barrier will also be required under Building Code clause F4 as there is a fall of 1 metre or more.)



### What the law says

#### Schedule 1 of the Building Act 2004

---

#### 24. Decks, platforms, bridges, boardwalks, etc

---

1. Building work in connection with a deck, platform, bridge, boardwalk, or the like from which it is not possible to fall more than 1.5 metres even if it collapses.

## 7. Platforms, decks and bridges

---

### 7.2. Short-span bridges on private land



Legally required professional:

**Chartered Professional Engineer**

Short-span bridges (span means the actual total length of deck less than 6 metres) could have various applications. They are commonly single span in structure and single lane in width, with abutments (supports) anchored to the banks of a stream or river. Short-span bridges are constructed above a stream or river's normal flow-level.

The falling height in this exemption is a vertical distance from the ground which should be measured from the lowest point of the river-bed, stream or creek to the top level of the bridge deck. Furthermore, the span is the actual distance between the vertical supports (abutments) of a bridge which are anchored into the river bank. If the short-span bridge has multiple piers or spans, the total length of deck must be less than 6 metres.

The intended usage of a bridge can cover various cases such as medium vehicles, pedestrians, cycle-ways, and farm trucks. In farms and private properties, short-span bridges are sometimes designed to pass over a stream or river. Some farmers might use the short-span bridges to facilitate their farm-related operational activities.



Under this exemption, short-span bridges must not be used by a member of public.

[Bridge design is commonly done in accordance with the Bridge Design Manual](#) and this manual is a highly recommended technical reference document.

Engineering knowledge is needed to consider the loading conditions, ground conditions and to make the appropriate classification based on the loads and frequency of use the bridge is likely to encounter during its life span (eg light-duty vs heavy-duty). For this exemption to apply, an owner must engage a chartered professional engineer (we recommend a structural and geotechnical engineer) to design the short-span bridge and the building work must be carried out in accordance with that design.



We note that resource consents may be required for short-span bridges location on farms. Most short-span bridges will be anchored to the bank of the stream or river, as they need to comply with council plans (administered by city, district and/or regional councils) under the Resource Management Act (RMA).

If a short-span bridge (owned by a farmer) crosses over the utility networks such as a railway, the farmer should seek advice from their city or district council (territorial authority) and/or consult with the relevant network utility operator (ie Kiwirail) to avoid any potential breach of the RMA or other relevant regulations.

It is recommended that weight or speed limit signs be fixed to the short-span bridges. Whilst installing the appropriate signs generally limits the liability of local authorities for issues resulting from the overloading of short-span bridges on private land, it could also warn other users of short-span bridges such as firefighters or employees.

It should be emphasised that having this exemption for certain size of bridges doesn't prevent the councils from exercising their power to give discretionary exemptions under the Building Act 2004.

[Clause 2 of Part 1 of Schedule 1 of the Building Act 2004](#), which covers discretionary exemptions by councils.

## Examples

---



### What is exempt

---

1. A farm owner wants to build a short-span bridge over a small creek on their land with a clear span of 5 metres between supports and a fall height of less than 2 metres. The bridge design is undertaken by a chartered professional engineer (structural and geotechnical) and the bridge has capacity signage along with a Building Code complaint barrier. The bridge will only be used by small trucks or small agricultural machinery owned and operated by the farm owner.



### What needs consent

---

1. A landowner is constructing a small bridge over a river on private land where the bridge is likely to be used by the public or employees of nearby businesses. A building consent is required for this building work as it will be used by members of the public.
- 
2. A horse breeder wants to build a small short-span bridge over a river on private land which will not be used by the public. The bridge span which is the actual total length of deck is equal to 7 metres. A building consent is required for this building work as it spans more than 6 metres.



### What the law says

#### Schedule 1 of the Building Act 2004

---

#### 47. Short-span bridges on private land

---

1. Building work in connection with a bridge that—
  - (a). has a span of less than 6 metres; and
  - (b). does not span a road, a railway, or any other area with public access; and
  - (c). is not used by the general public; and
  - (d). has a safety barrier.
2. However, subclause (1) does not apply to a bridge from which it is possible to fall further than 3 metres even if it collapses.





## 8. Shelters, shades and carports

This section includes building work for carports, shade sails and ground floor awnings, along with the construction or removal of tents, marquees and similar lightweight structures in private or public areas.

The table below shows the exemptions included in this section and the professional you will need to hire.

Description*	Is an authorised professional legally required?	Who can provide professional advice?
8.1. Carports not exceeding 20 square metres in floor area	No	Licensed Building Practitioner or Chartered Professional Engineer
8.2. Carports exceeding 20 square metres in floor area, but not exceeding 40 square metres	Yes	Chartered Professional Engineer
8.3. Carports exceeding 20, but not exceeding 40, square metres in floor area	Yes	Licensed Building Practitioner
8.4. Shade sails	No	Licensed Building Practitioner
8.5. Tents, marquees, and similar lightweight structures	No	Product supplier
8.6. Awnings up to 20 square metres	No	Licensed Building Practitioner or Chartered Professional Engineer
8.7. Awnings exceeding 20 square metres in size, but not exceeding 30 square metres	Yes	Chartered Professional Engineer
8.8. Awnings exceeding 20 square metres in size, but not exceeding 30 square metres	Yes	Licensed Building Practitioner

\*Owners must look at the relevant section of guidance to identify under which detailed conditions the building work qualifies for the exemption.

## Notes for carports: 8.1-8.3

---

A carport is a roofed structure that is used for motor vehicle storage. To be regarded as a carport, at least one side of the structure must be open to the outdoors at all times.

There are three separate exemptions for carports. You will need to check which professional to hire according to the specifications.

- Carports up to 20 square metres in floor area
- Carports up to 40 square metres in floor area, when the design is carried out or reviewed by a Chartered Professional Engineer, OR
- Carports up to 40 square metres in floor area, when a Licensed Building Practitioner is to carry out or supervise design and construction

**Before you begin your project, you need to consider the following:**

---

### **Stormwater**

You need to consider the Building Code requirements regarding the disposal of stormwater from the roof of your building. You may need to seek professional guidance and seek approval from your council. All new drains must be laid by an authorised drainlayer.

### **District planning**

Always check with your local council to make sure your proposed building work does not have any district planning implications taking consideration of maximum site coverage, yard or setback requirements, daylight access planes or permitted activities. A resource consent may be required and it is important that this is obtained before starting any building work.

### **Building close to boundaries**

If you are building close to boundaries, you need to consider the Building Code requirements regarding protection from fire, particularly in relation to the external spread of fire to neighbouring property.

### Measuring the net floor area

The net floor area in a building is measured to the inside of the enclosing walls or posts/columns.

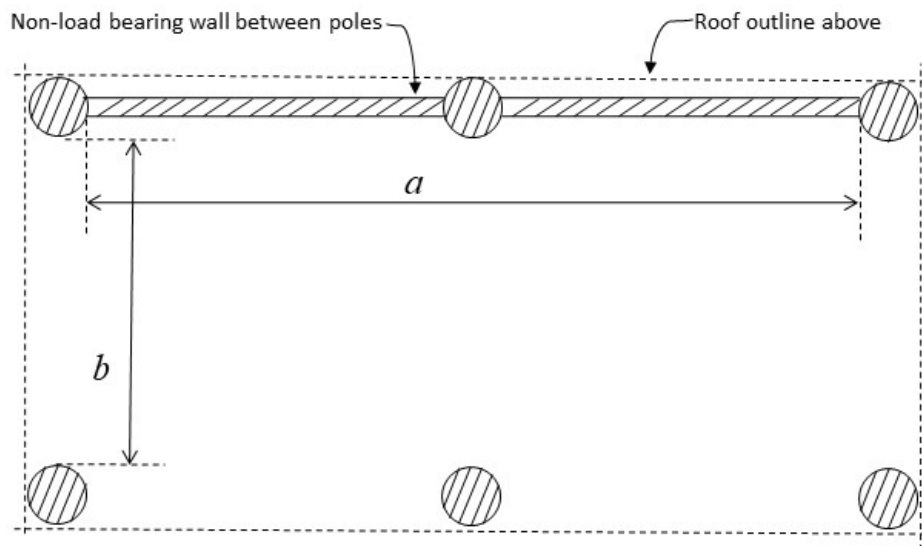

$$\text{Net floor area} = a \times b$$

## 8. Shelters, shades and carports

---

### 8.1. Carports not exceeding 20 square metres in floor area



#### **Amended June 2016**

Clause 18 of Schedule 1 was amended, as from 30 June 2016, by Building (Exempt Building Work) Order 2016. This order replaced clause 18 to remove the condition that required a carport to be on or attached to an existing building.

This exemption covers carports up to 20 square metres in area.

Before you begin, please read the Notes for carports on page 134.

If a homeowner intends to build a carport greater than 20 square metres on the ground floor, exemption 44 or 18A (sections 8.2. or 8.3.) might be applicable.



## Examples

---



### What is exempt

---

1. A home owner wants to construct a new free-standing carport. The carport will have a concrete slab on grade, be open on all sides, and have a net floor area of 20 square metres.

---

2. A courier company intends to build a 20 square metre carport. The carport will be open on three sides and attached to the existing single storey depot building.



### What needs consent

---

1. Constructing a new free-standing carport with a net floor area of 25 square metres which will be open on all sides. As it exceeds 20 square metres in floor area, a building consent is required.



### What the law says

#### Schedule 1 of the Building Act 2004

---

#### 18. Carports not exceeding 20 square metres in floor area

---

1. Building work in connection with a carport that:
  - (a). is on the ground level; and
  - (b). does not exceed 20 square metres in floor area.

## 8. Shelters, shades and carports

### 8.2. Carports exceeding 20 square metres in floor area, but not exceeding 40 square metres



Legally required professional:

**Chartered Professional Engineer**

If using this exemption, a homeowner must engage a Chartered Professional Engineer to design a carport greater than 20 square metres and not exceeding 40 square metres and subsequently, the work must be carried out in accordance with that design. Some suppliers/manufacturers of proprietary products have pre-engineered kit-sets with a unified sign-off from a Chartered Professional Engineer.



If a homeowner intends to build a carport less than 20 square metres on the ground floor, exemption 18 (section 8.1) might be applicable. If the proposed carport is between 20 and 40 square metres, exemption 18A (section 8.3) may apply.

## Examples



### What is exempt

1. A home owner wants to construct a new free-standing carport. The carport will have a concrete slab on grade, be open on all sides, and have a net floor area of 30 square metres. The design is carried out (or reviewed) by a Chartered Professional Engineer and the work is carried out in accordance with that design.

---

2. Making an alteration to an existing 20 square metre carport by adding an extra 20 square metres so that the maximum size is 40 square metres. As long as the design is carried out or reviewed by a Chartered Professional Engineer and the work is carried out in accordance with that design.



### What needs consent

1. Constructing a new free-standing carport with a net floor area of 43 square metres which will be open on all sides. As it exceeds 40 square metres in net floor area, a building consent is required.

---

2. Making an alteration to an existing 20 square metre carport by adding an extra 30 square metres. This exceeds 40 square metres in net floor area, so a building consent is required.



### What the law says

#### Schedule 1 of the Building Act 2004

#### 44. Carports exceeding 20, but not exceeding 40, square metres in floor area

1. Building work in connection with a carport that—
  - (a). is on the ground level; and
  - (b). exceeds 20 square metres in floor area, but does not exceed 40 square metres.

This exemption also requires that the design of the building work has been carried out or reviewed by a Chartered Professional Engineer and the building work has been carried out in accordance with that design.

## 8. Shelters, shades and carports

---

### 8.3. Carports exceeding 20, but not exceeding 40, square metres in floor area



Legally required professional:

**Licensed Building Practitioner**

This exemption relates to roofed structures that are used for motor vehicle storage. To be regarded as a carport, at least one side of the structure must remain open to the outdoors at all times. This exemption also includes all work relating to the disposal of storm-water as it relates to the carport.

To qualify for this exemption, a home owner must engage a Licensed Building Practitioner to design, construct and/or supervise any carport with a net floor area (which is taken to be the area within the posts and/or walls supporting the roof structure) not exceeding 40 square metres and the work must be carried out in accordance with that design.

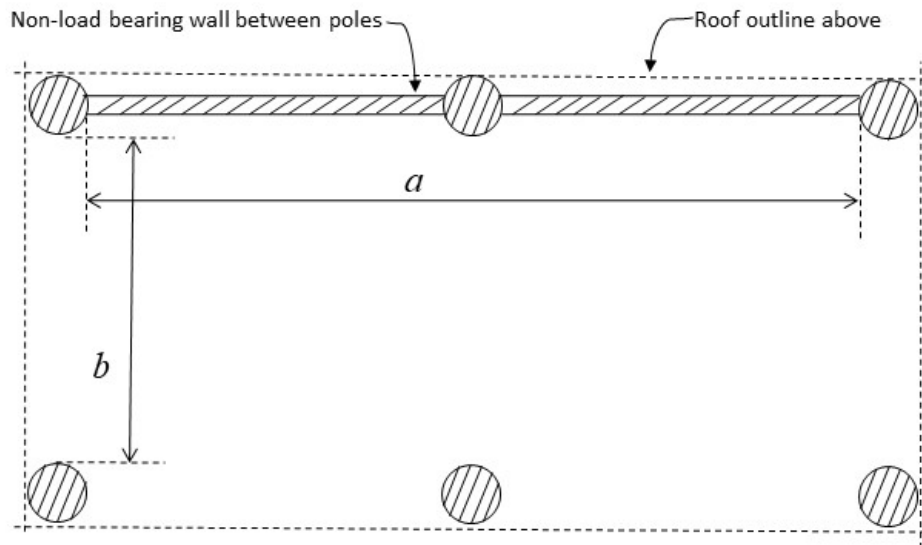

$$\text{Net floor area} = a \times b$$

Any design or construction work done using this exemption must be carried out or supervised by a Licensed Building Practitioner (LBP). Homeowners are encouraged to seek LBPs with the right competence for this work, as this provides the best assurance.

The design work is best carried out by a LBP holding a Design licence. The construction work is best carried out by an LBP in one of the following licensing classes, as may be relevant to the building work planned to be undertaken:

- Bricklaying and blocklaying
- Carpentry
- External plastering
- Foundations
- Roofing

Refer to the Who can undertake exempt work section on page 11 for more information about licensed building practitioners.

**i** You should check and confirm the LBPs current licensing status and licensing history before you engage them to carry out work under this exemption.

If supervision is being applied by a Licensed Building Practitioner under this exemption, that supervision must align with the Practice Note issued for Supervision by LBPs, which can be found at [www.lbp.govt.nz](http://www.lbp.govt.nz).

If the proposed carport is between 20 and 40 square metres, exemption 44 (section 8.2) may apply.

## Examples

---



### What is exempt

---

1. A home owner wants to build a new free-standing carport. The carport will have a concrete slab on grade, be open on all sides, and have a net floor area of 25 square metres. As the owner has contracted a Licensed Building Practitioner to undertake the design, construction and/or supervise the building work, a building consent is not required.

---

2. A courier company intends to build a 35 square metre carport. The carport will be open on three sides and attached to the existing single storey depot building. As the owners have contracted a Licensed Building Practitioner to undertake the design, construction and/or supervise the building work, a building consent is not required.



### What needs consent

---

1. Constructing a new free-standing carport with a net floor area of 43 square metres which will be open on all sides. As it exceeds 40 square metres in floor area, a building consent is required.



### What the law says

#### Schedule 1 of the Building Act 2004

---

#### 18A. Carports exceeding 20, but not exceeding 40, square metres in floor area

---

1. Building work in connection with a carport if—
  - (a). any design or construction work is carried out or supervised by a Licensed Building Practitioner; and
  - (b). the carport—
    - (i). is on the ground level; and
    - (ii). exceeds 20 square metres in floor area, but does not exceed 40 square metres.

## 8. Shelters, shades and carports

### 8.4. Shade sails



This exemption recognises the relatively simple, low-risk nature of shade sails. These are usually made of fabric and either attached to the outside of a building or freestanding with their own support structures. They are often used to cover a deck, patio or children’s play equipment to provide sun protection.

While there may be significant wind loadings on shade sails – something that should be carefully considered during their design and assembly – there is very little building work involved in their construction or installation apart from erecting and making connections to structural supports.

**i** If you are attaching shade sails to the exterior of a building, you need to pay particular attention to weathertightness detailing. All mechanical connections which penetrate the building envelope and provide support to shade sails, such as nuts, bolts and coach screws, must prevent moisture from getting into the building.

### Examples



#### What is exempt

1. A shade sail is to be installed above a deck at the first storey level of a dwelling located in the middle of a large rural property. The proposed shade sail has a total area of 20 square metres and meets all Building Code requirements.

2. A shade sail is to be erected above a sandpit at a childcare centre. The proposed shade sail has a total area of 42 square metres and is 2 metres away from the nearest boundary.
3. A number of shade sails, each 12 square metres in size, are to be erected in a public park.
4. The owner of a café decides to install several shade sails, each 9 square metres in size, in an outdoor courtyard to provide sun protection for customers.
5. An old shade sail, 20 square metres in size, above a patio at ground level is to be replaced with a shade sail of 30 square metres.



### What needs consent

1. A shade sail with an area of 30 square metres is to be installed above a balcony on the fifth floor of an apartment block. As this will be located on other than the ground or first storey level of the building, a building consent is required.
2. A shade sail is to be erected above a play area at a kindergarten. The proposed shade sail has a total area of 50 square metres and will be located on the boundary. As it will be closer than 1 metre from the legal boundary, the kindergarten will need to obtain a building consent.
3. A shade sail with an area of 60 square metres is to be installed above an open courtyard at a shopping complex. Since the shade sail will be greater than 50 square metres, a building consent is required.



### What the law says

#### Schedule 1 of the Building Act 2004

#### 19. Shade sails

Building work in connection with a shade sail made of fabric or other similar lightweight material, and associated structural support, that:

- (a). does not exceed 50 square metres in size; and
- (b). is no closer than 1 metre to any legal boundary; and
- (c). is on the ground level, or, if on a building, on the ground or first-storey level of the building.



## 8. Shelters, shades and carports

---

### 8.5. Tents, marquees, and similar lightweight structures



This exemption allows you to construct, alter or remove a tent or marquee that is being used either for public assembly (eg at a school gala) or private use (eg for a wedding reception). However, this is only if the tent or marquee does not exceed 100 square metres and is not in place for more than a month.

This exemption also recognises the simple construction and temporary nature of stalls used at fairs, exhibitions (such as trade shows) and market events.

The restrictions on maximum floor area have been imposed to avoid potential safety problems.

## Examples

---



### What is exempt

---

1. The owner of a restaurant puts up a marquee with a floor area of 80 square metres outside their restaurant to cater for extra patrons during a sports event. The marquee is dismantled the next day.

---
2. A large number of tents and marquees are erected on a sports ground for a three day long wine and food festival. Each tent and marquee has a floor area of less than 100 square metres.

---
3. A tent is erected for the display of farm animals at a field show over the weekend. The tent has a floor area of 90 square metres.

---
4. A property owner erects a tent with a floor area of 90 square metres for a birthday function in their back yard. It will only be there for four days over the Easter weekend.

---
5. A 75 square metre stall is put up at a trade show for a week.

---
6. The owner of a weekend market stall increases the stall's size from 50 square metres to 70 square metres.

---
7. The operator of a fun fair erects a number of booths for four weeks. The booths are not physically connected to each other and none of them have a floor area of more than 100 square metres.

---
8. Following a recent increase in the number of car park users at an exhibition centre, an additional ticket booth is installed in the car park for a week until a more permanent solution can be found. The floor area of the booth is 6 square metres.



### What needs consent

1. A marquee with a floor area of 125 square metres is erected for a function. Although the function is only for a night, the marquee is over the 100 square metre size limitation and will require a building consent.

---

2. A vineyard owner erects a marquee with a floor area of 75 square metres for wine tasting. They plan to keep the marquee up for 3 months over summer, so a building consent is required.

---

3. A circus company intends to erect a tent with a floor area of 300 square metres for its show. This exceeds the maximum allowable floor area of 100 square metres and will require a building consent.

---

4. Two 75 square metre marquees are erected and then joined together by an enclosed awning. This causes the size of the joined marquees to go beyond the 100 square metre limitation so a building consent is required.

---

5. A café owner proposes to erect a permanent 90 square metre marquee for patrons to use. As she intends this marquee to remain in place for longer than a month, a building consent is required.

---

6. Organisers of a wine and food festival put up several 125 square metre stalls. As the area of each stall is greater than 100 square metres, a building consent is required.



### What the law says

#### Schedule 1 of the Building Act 2004

#### 5. Tents, marquees, and similar lightweight structures

Building work in connection with any tent or marquee, or any similar lightweight structure (for example, a stall, booth, or compartment used at fairs, exhibitions, or markets) that:

- (a). does not exceed 100 square metres in floor area; and
- (b). is to be, or has been, used for a period of not more than 1 month.

## Notes for Awnings: 8.6–8.8

---

There are three separate exemptions for awnings. You will need to check which professional to hire according to the specifications.

- Awnings up to 20 square metres in size on the ground floor or first storey level
- Awnings up to 30 square metres in size on the ground floor level, when the design is carried out or reviewed by a Chartered Professional Engineer, OR
- Awnings up to 30 square metres in size on the ground floor level, when a Licensed Building Practitioner is to carry out or supervise design and construction.

**Before you begin your project, you need to consider the following:**

---

### **Weather-tightness**

If you are carrying out any building work in relation to awnings, you need to be particularly careful in relation to their weather-tightness. All mechanical connections which penetrate the building envelope and provide support to awnings such as nuts, bolts or coach screws, must provide adequate resistance to stop moisture penetrating the building, as required under Building Code clause E2 – External moisture.

### **Public access**

To be exempt from needing a building consent, awnings must not overhang any area accessible by the public, including private areas with limited public access, for example, restaurants and bars.

## 8. Shelters, shades and carports

---

### 8.6. Awnings up to 20 square metres

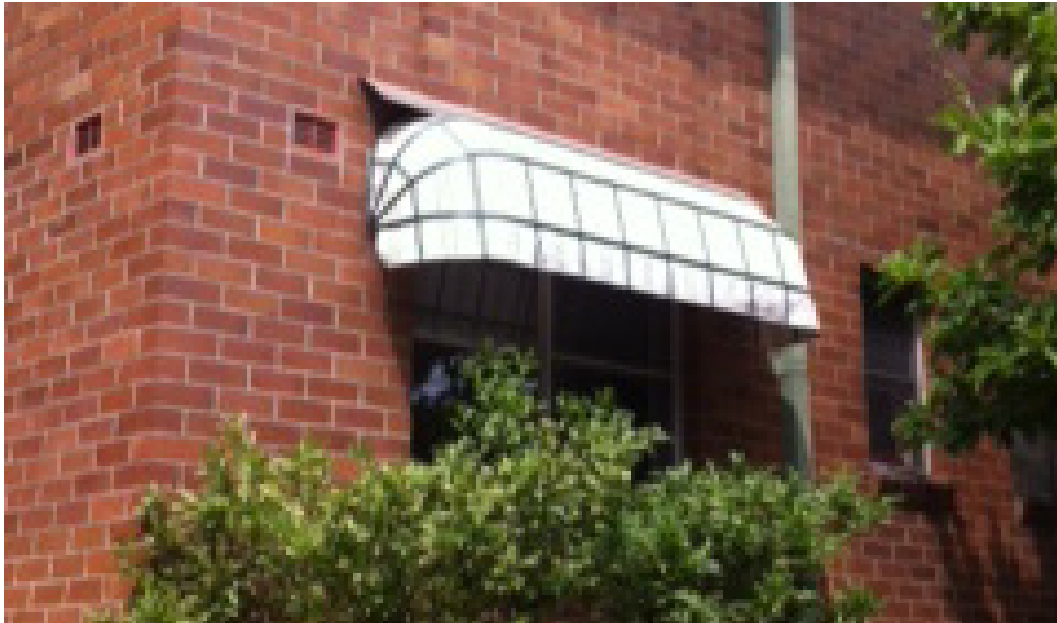

**Amended June 2016**

The scope of this exemption was expanded on 31 August 2020. See sections 8.7. and 8.8.

This exemption relates to awnings up to 20 square metres in size which are currently, or are to be, attached to a building's external envelope or exterior surfaces.



If an owner intends to build an awning greater than 20 square metres on the ground floor, exemption 16A or 45 (sections 8.8 or 8.7) may be applicable.

## Examples

---



### What is exempt

---

1. A homeowner intends to install a retractable canvas awning of 10 square metres above a ground floor kitchen window and over the adjoining deck to provide shade.



### What needs consent

---

1. A lightweight fabric awning is to be fitted above an apartment deck on the third floor of the building. Although the awning has a total coverage of 18 square metres, a building consent is required as it is higher than the ground floor level.



### What the law says

---

#### Schedule 1 of the Building Act 2004

---

#### 16. Awnings not exceeding 20 square metres in size

---

Building work in connection with an awning that:

- (a). is on or attached to an existing building; and
- (b). is on the ground or first-storey level of the building; and
- (c). does not exceed 20 square metres in size; and
- (d). does not overhang any area accessible by the public, including private areas with limited public access, for example, restaurants and bars.

## 8. Shelters, shades and carports

### 8.7. Awnings exceeding 20 square metres in size, but not exceeding 30 square metres



Legally required professional:

**Chartered Professional Engineer**

This exemption relates to awnings between 20 and 30 square metres where the design is carried out or reviewed by a chartered professional engineer and the work is carried out in accordance with that design. They may only be built on the ground floor of a building.

Before you begin, please read the Notes for awnings on page 148.

An owner must engage a chartered professional engineer to design the awnings on the ground level greater than 20 square metres and not exceeding 30 square metres. Constructing the awning needs to be carried out in accordance with that design.

Some suppliers/manufacturers of proprietary products have pre-engineered kit-sets with a unified sign-off from a chartered professional engineer. The kit-set awning needs to be constructed in accordance with the instruction manual in order to be exempt from needing a building consent.



If an owner intends to erect an awning less than 20 square metres on the ground floor, exemption 16 (section 8.6) may be applicable.

## Examples

---



### What is exempt

---

1. A home owner intends to install a retractable canvas awning of 25 square metres above a ground floor kitchen window and over the adjoining deck to provide shade. The structural design of the awning has been reviewed by a chartered professional engineer and the work is carried out in accordance with that design.



### What needs consent

---

1. A lightweight fabric awning is to be fitted above an apartment deck on the third floor of the building. Although the awning has a total coverage of 25 square metres a building consent is required as the awning is not on the ground floor.



### What the law says

---

#### Schedule 1 of the Building Act 2004

---

#### 45. Awnings exceeding 20, but not exceeding 30, square metres in size

---

1. Building work in connection with an awning that—
  - (a). is on or attached to an existing building; and
  - (b). in on the ground level of the building; and
  - (c). exceeds 20 square metres in size, but does not exceed 30 square metres; and
  - (d). does not overhang any area accessible by the public, including private areas with limited public access, for example, restaurants and bars.



## 8. Shelters, shades and carports

### 8.8. Awnings exceeding 20 square metres in size, but not exceeding 30 square metres



Legally required professional:

**Licensed Building Practitioner**

This exemption relates to awnings between 20 and 30 square metres where the design and construction of the awning is carried out by a Licensed Building Practitioner and the work is carried out in accordance with that design. They may only be built on the ground floor of a building.

Before you begin, please read the Notes for awnings on page 148.

Any design or construction work done using this exemption must be carried out or supervised by a Licensed Building Practitioner (LBP). Building owners are encouraged to seek LBPs with the right competence for this work, as this provides the best assurance.

The design work is best carried out by a LBP holding a Design licence. The construction work is best carried out by an LBP in one of the following licensing classes, as may be relevant to the building work planned to be undertaken:

- Bricklaying and blocklaying
- Carpentry
- External plastering
- Foundations
- Roofing

Please refer to the Who can undertake exempt work on page 11 for more information about Licensed Building Practitioners.

 You should check and confirm the LBPs current licensing status and licensing history before you engage them to carry out work under this exemption.

If supervision is being applied by a Licensed Building Practitioner under this exemption, that supervision must align with the practice note issued for supervision by LBPs, which can be found at [www.lbp.govt.nz](http://www.lbp.govt.nz).

## Examples



### What is exempt

1. A home owner intends to install a retractable canvas awning of 21 square metres above a ground floor kitchen window and over the adjoining deck to provide shade. This can be designed and constructed by a Licensed Building Practitioner under this exemption.



### What needs consent

1. A lightweight fabric awning is to be fitted above an apartment deck on the third floor of the building. Although the awning has a total coverage of 18 square metres, a building consent is required as it is higher than the ground floor level.
- 
2. A restaurant building owner wants to install an awning over an outdoor seating area for the restaurant. The awning will be 25 square metres and on the ground floor, but because the area is accessible by the public, this exemption does not apply.



### What the law says

#### Schedule 1 of the Building Act 2004

#### 16A. Awnings exceeding 20, but not exceeding 30, square metres in size

1. Building work in connection with an awning if—
  - (a). any design or construction work is carried out or supervised by a Licensed Building Practitioner; and
  - (b). the awning—
    - (i). (i) is on or attached to an existing building; and
    - (ii). (ii) is on the ground level of the building; and
    - (iii). exceeds 20 square metres in size, but does not exceed 30 square metres; and
    - (iv). does not overhang any area accessible by the public, including private areas with limited public access, for example, restaurants and bars.



## 9. Fencing and restrictions

---

This section includes fences and hoardings (excluding around a swimming pool) and the means of restricting access to small heated pools. It also covers height-restriction gantries which restrict vehicles from entry to a space.

The table below shows the exemptions included in this section and the professional you will need to hire.

Description	Is an authorised professional legally required?	Who can provide professional advice?
9.1. Fences and hoardings	No	Licensed Building Practitioner
9.2. Means of restricting access to small heated pools	No	Licensed Building Practitioner
9.3. Height-restriction gantries	No	Licensed Building Practitioner or Chartered Professional Engineer

## 9. Fencing and restrictions

---

### 9.1. Fences and hoardings



#### Amended Jan 2017

Subclause (2) was replaced, as from 1 January 2017, by s18(2) Building (Pools) Amendment Act 2016.

Any building work relating to fences (which includes garden walls) and hoardings up to 2.5 metres high is covered by this exemption and will not need a building consent. Fences to swimming pools are outside the scope of this exemption and will require building consent.

Hoardings are often put up around building construction sites and are only there temporarily to ensure public safety during the construction phase.

To check the height of your fence or hoarding against the 2.5 metre limit for this exemption, measure the vertical distance between the top of the structure and the supporting ground directly below.

Note that you will still need to comply with the requirements of the Fencing Act 1978 for boundary fences. In many cases, district plans made under the Resource Management Act 1991 may also require you to obtain a resource consent for fences over a certain height (usually over 2 metres).

## Examples



### What is exempt

1. Constructing a 2.0 metre high concrete block wall along a boundary to create a private back yard.
2. Building a 2.2 metre high timber paling fence in a back yard to act as a windbreak for a barbeque area.
3. Installing a 2.4 metre high hoarding around a construction site to ensure public safety.
4. A concert organiser proposes to erect mesh fencing 1.8 metres high to stop concert goers getting onto the stage.



### What needs consent

1. A building owner proposes to erect a 3.5 metre high wire mesh fence around their tennis court, well clear of any boundaries. As the fence height is greater than 2.5 metres, a building consent is required.
2. An owner wants to build a new timber fence with an overall height of 3 metres along the rear boundary of their property. As the fence height is greater than 2.5 metres, they will need to obtain a building consent.
3. The owner of a residential dwelling intends to extend a 2.8 metre high concrete block wall alongside a neighbouring boundary. As the fence height is greater than 2.5 metres, a building consent is required.
4. A building owner proposes to erect a new 1.2 metre high fence around a swimming pool. A building consent is required and the fence installed before the pool is filled with water. Regular three-yearly inspections will be required from the date of the code compliance certificate.



### What the law says

#### Schedule 1 of the Building Act 2004

#### 21. Fences and hoardings

1. Building work in connection with a fence or hoarding in each case not exceeding 2.5 metres in height above the supporting ground.
2. Subclause (1) does not include a fence or hoarding to restrict access to a residential pool.

## 9. Fencing and restrictions

### 9.2. Means of restricting access to small heated pools



#### Amended January 2017

Clause 21A was inserted, as from 1 January 2017, by s18(3) Building (Pools) Amendment Act 2016.

Under exemption 9.2., a building consent is not required for the means of restricting access where a safety cover is used on a small heated pool, such as a spa pool with a water surface area of 5 square metres or less. The top surface of every wall of the pool must be at least 760 millimetres above the adjacent floor or ground at all points and the walls of the pool must be non-climbable.

If the cover used does not comply with Building Code clause F9.3.5, it is not considered to be a safety cover.

For a safety cover to comply with F9.3.5 it must:

- restrict the entry of children when closed
- be able to withstand a reasonably foreseeable load
- be able to be readily returned to the closed position
- have signage indicating its child safety features.

Where a small heated pool has a safety cover, it also does not need to be inspected every three years as fencing to other residential pools are (section 162D of the Building Act 2004).



 The following terms are defined in this document's glossary:

- 'abode' or 'place of abode'
- 'pool'
- 'residential pool'
- 'small heated pool'.

Construction specifications for covers that comply with F9.3.5 are provided in Acceptable Solution F9/AS2.

## Examples



### What is exempt

1. A home owner wishes to install a rectangular spa pool with internal dimensions of 2.4 and 1.2 metres, with a safety cover on it. The safety cover fully complies with the requirements of Building Code clause F9.3.5.



### What needs consent

1. An owner of a residential property intends to construct a rectangular 'endless' (ie a current is created to swim against) exercise pool with internal dimensions of 3 and 2 metres, with a safety cover. As the pool surface area is greater than 5 square metres, it does not fit into the definition of a 'small heated pool' and a building consent is required for the means of restricting access.
2. A homeowner proposes to install a spa pool with a lightweight cover that is easy to lift or remove. As the cover is unlikely to fully comply with Building Code clause F9.3.5, it is not considered to be a safety cover and building consent is required for the means of restricting access, unless the cover is modified or replaced to comply.



### What the law says

#### Schedule 1 of the Building Act 2004

#### 21A. Means of restricting access to small heated pools

1. Installation of a safety cover as a means of restricting access to a small heated pool that is a residential pool.

## 9. Fencing and restrictions

---

### 9.3. Height-restriction gantries



This exemption only applies to height-restriction gantries, such as gantries that restrict vehicles over a certain height from going into a car parking building or beneath an underpass.

## Examples

---



### What is exempt

---

1. Constructing a new height-restriction gantry for a car parking building.
2. Replacing a damaged wooden height-restriction gantry with a new steel one.
3. Installing a new height-restriction gantry for a drive-through at a fast food restaurant.
4. Repairing a height-restriction gantry at a car parking building following impact damage from a vehicle.



### What needs consent

---

1. Constructing a pedestrian bridge over a ramp which provides vehicle access to a basement customer car park. Although the bridge limits the height of vehicles that can use the ramp to a maximum of 2.1 metres, the main purpose of the bridge is to allow pedestrians and customers to cross safely over the vehicle ramp. Building a bridge is beyond the scope of this exemption and also of exemption 7.1., as the bridge will be higher than 1.5 metres. Therefore, this will require a building consent.



### What the law says

---

#### Schedule 1 of the Building Act 2004

---

#### 26. Height-restriction gantries

---

1. Building work in connection with a height-restriction gantry.



# 10. Playground equipment

---

This section includes private household and certain public playground equipment.

For playground removals, refer to section 1.5 Removal of structures.

The table below shows the exemptions included in this section and the professional you will need to hire.

Description*	Is an authorised professional legally required?	Who can provide professional advice?
10.1. Private household playground equipment	No	Licensed Building Practitioner
10.2. Certain public playground equipment	Yes, a Chartered Professional Engineer must be used for both construction and demolition	Chartered Professional Engineer

\*Owners must look at the relevant section of guidance to identify under which detailed conditions the building work qualifies for the exemption.

## 10. Playground equipment

---

### 10.1. Private household playground equipment



Playground equipment can be built to a maximum height of 3 metres for use by a single private household under this exemption.

Building work relating to playground equipment on publicly accessible sites is not covered by this exemption. However, it may fall under exemption 42 (section 10.2) (certain public playground equipment).

## Examples

---



### What is exempt

---

1. Owners of a dwelling intend to install a playhouse and slide in their garden for their four year old child. The highest part of the equipment is less than 3 metres above the supporting ground.



### What needs consent

---

1. Homeowners intend to install a swing and slide in their garden for their children. The top of the swing set and the platform giving access to the slide (which is also fitted with 1 metre high safety barriers) is 3.5 metres above the supporting ground, and therefore requires a building consent.



### What the law says

---

#### Schedule 1 of the Building Act 2004

---

#### 28. Private household playground equipment

---

1. Building work in connection with playground equipment if:
  - (a). the equipment is for use by a single private household; and
  - (b). no part of the equipment exceeds 3 metres in height above the supporting ground level.

## 10. Playground equipment

---

### 10.2. Certain public playground equipment



This exemption recognises that the building consent process would add disproportionately high compliance costs and limited value in cases where certain public playground equipment is either designed or reviewed by a Chartered Professional Engineer.

This exemption applies to playgrounds under the control of certain public or licensed organisations that already have strong incentives to operate systems to make sure public safety concerns are well managed.

[Refer to the Removal of structures section](#) [↑](#) if you wish to remove playground equipment.



## Examples

---



### What is exempt

---

1. New playground equipment, designed by a Chartered Professional Engineer, in an existing or new licensed childcare centre.
2. A primary school installs new playground equipment, where the design has been reviewed by a Chartered Professional Engineer.



### What needs consent

---

1. New playground equipment at an existing childcare centre not designed or reviewed by a Chartered Professional Engineer.



### What the law says

Schedule 1 of the Building Act 2004

---

#### 42. Certain public playground equipment

---

1. Building work in connection with playground equipment if the work is for a government department, Crown entity, licensed early childhood centre, territorial or regional authority, or other similar public organisation.



# 11. Pools, tanks, and dams

---

This section includes tanks, pools, dams and flexible water storage bladders for irrigation or firefighting purposes, up to a certain size.

The table below shows the exemptions included in this section and the professional you will need to hire.

Description*	Is an authorised professional legally required?	Who can provide professional advice?
11.1. Tanks and pools	No	Chartered Professional Engineer
11.2. Dams (excluding large dams)	No	Chartered Professional Engineer
11.3. Flexible water storage bladders	No	Product supplier

\*Owners must look at the relevant section of guidance to identify under which detailed conditions the building work qualifies for the exemption.

# 11. Pools, tanks, and dams

## 11.1. Tanks and pools



### Amended January 2017

The heading to clause 23 was amended, as from 1 January 2017, by s18(4) Building (Pools) Amendment Act 2016 by deleting "(excluding swimming pools)". Clause 23 was amended, as from 1 January 2017, by s18(5) Building (Pools) Amendment Act 2016 by deleting "(except a swimming pool as defined in section 2 of the Fencing of Swimming Pools Act 1987)".

A building consent is not required for the construction of any tank or pool or its structural support. This is as long as various requirements are met relating to its capacity and height above the ground, as listed in subclauses (a) to (g) of exemption 11.1. This exemption is likely to cover many residential pools, such as an in-ground swimming pool of 7 metres long, 5 metres wide and a metre deep.

Note that this exemption excludes building work in connection with a fence or hoarding restricting access to a residential pool (see exemption 9.1.).

## Examples



### What is exempt

1. A rural property owner wants to install a 20,000 litre pre-cast concrete tank to collect and store rainwater from the house roof. They propose to place the tank directly on the ground in a corner of the front garden.

2. A rural homeowner wants to install a 2,000 litre water storage tank supported 2 metres above the supporting ground.
3. The owner of a dwelling intends to install a 600 millimetre deep fishpond in their garden with a capacity of 1,000 litres of water and supported directly by the ground.
4. As the pond is not normally used for swimming, paddling or bathing, it is not a pool and the barrier requirements before 1 January 2017 no longer apply.



### What needs consent

1. A rural homeowner wants to install a 1,000 litre water storage tank. To improve the water pressure, the owner intends to mount the tank on a steel tank stand. The tank will be supported more than 3 metres above the ground, so a building consent is required.



### What the law says

#### Schedule 1 of the Building Act 2004

#### 23. Tanks and pools

1. Building work in connection with a tank or pool and any structure in support of the tank or pool, including any tank or pool that is part of any other building for which a building consent is required, that:
  - (a). does not exceed 500 litres capacity and is supported not more than 4 metres above the supporting ground; or
  - (b). does not exceed 1,000 litres capacity and is supported not more than 3 metres above the supporting ground; or
  - (c). does not exceed 2,000 litres capacity and is supported not more than 2 metres above the supporting ground; or
  - (d). does not exceed 4,000 litres capacity and is supported not more than 1 metre above the supporting ground; or
  - (e). does not exceed 8,000 litres capacity and is supported not more than 0.5 metres above the supporting ground; or
  - (f). does not exceed 16,000 litres capacity and is supported not more than 0.25 metres above the supporting ground; or
  - (g). does not exceed 35,000 litres capacity and is supported directly by ground.

# 11. Pools, tanks, and dams

---

## 11.2. Dams (excluding large dams)



This exemption allows smaller dams to be built without needing to obtain a building consent. However, they will still need to comply with the Building Code.

A dam is defined in section 7 of the Building Act 2004 as meaning

- (a). an artificial barrier, and its appurtenant structures, that:
  - (i). is constructed to hold back water or other fluid under constant pressure so as to form a reservoir; and
  - (ii). is used for the storage, control, or diversion of water or other fluid
- (b). includes a flood control dam, a natural feature that has been significantly modified to function as a dam and a canal but does not include a stopbank designed to control floodwaters.

Large dams are not covered by this exemption. A large dam is defined in section 7 of the Building Act 2004 as meaning a dam that has a height of 4 or more metres and holds 20,000 cubic metres volume of water or other fluid.

This is about the capacity of eight Olympic-sized swimming pools, or a rugby field with water approximately 3 metres deep (up to the crossbars of the goal posts).

How the height of the dam is measured differs slightly based on whether the dam is across a stream, or if the dam is a canal.

If the dam is across a stream, the height of the dam is the vertical distance from the dam crest to the natural bed of the stream at the lowest downstream outside limit of the dam.

If the dam is not across a stream, the height of the dam is the vertical distance from the dam crest to the lowest elevation at the outside limit of the dam.

If the dam is a canal, the height of the dam is the vertical distance from the dam crest to the invert of the canal.

The dam crest is defined in section 7 of the Building Act 2004 as the uppermost surface of the dam, not taking into account any camber allowed for settlement, or any curbs, parapets, guard rails or other structures that are not part of the water-retaining structure. Note that any freeboard is part of the water-retaining structure.

## Examples



### What is exempt

1. A farmer constructs a water reservoir for crop irrigation. The height of the dam is 3.5 metres and it retains a depth of 2.5 metres over an area of 5,000 square metres (approximately 12,500 cubic metres of water). This is exempt work as the height of the dam is less than 4 metres and the volume of the water that is held back is less than 20,000 cubic metres.



### What needs consent

1. The height of a proposed dam on a river is 20 metres and it will hold back more than 250,000 cubic metres of water. This work will require a building consent because the dam height is greater than 4 metres and the reservoir volume is greater than 20,000 cubic metres.



### What the law says

#### Schedule 1 of the Building Act 2004

#### 22. Dams (excluding large dams)

Building work in connection with a dam that is not a large dam.

# 11. Pools, tanks, and dams

---

## 11.3. Flexible water storage bladders



Flexible water storage bladders are pillow-shaped tanks or containers used for the storage of water. These bladder tanks are supported directly on the ground, which commonly does not need any form of foundation design as they are flexible and can deform with the ground. The friction forces provide lateral stability to water storage bladders (once they are full) and prevent lateral movement. Owners should follow all safety precautions issued by the suppliers/manufacturers to avoid harm.

Note that locating flexible storage bladders on sloped ground is not in accordance with any supplier or manufacturer's installation instructions.

It is important to consider the geotechnical risks when placing flexible water storage bladders on the ground as this can create an additional surcharge on a relatively large surface area. Sometimes minor site works might be needed to minimise surface irregularities to reduce the chance of abrasion and water bladder failure. Purchasers and owners might need to seek further professional advice if they want to place the flexible water storage bladders on or near sloping ground or not on good ground.

This exemption limits the capacity of flexible storage bladders to no more than 200,000 litres and the height above the ground can be no more than 2 metres. These limits have been set to reduce the potential risks to surrounding property and infrastructure in the event of a failure.

These bladders can be used to store a variety of liquids, some of which, if a leak or discharge occurred, could have a detrimental impact on the environment. This exemption is therefore limited to the storage of water used only for irrigation or firefighting purposes.



 Always check with your local council to make sure your proposed building work does not have any district planning implications. A resource consent may be required and it is important that you obtain this before starting any building work.

The connection of a potable water supply pipe to fill a flexible water storage bladder requires a building consent, and would need to be installed by an Authorised Plumber.

## Examples

---



### What is exempt

---

1. A factory owner wants to install a flexible water storage bladder with a 90,000 litre capacity within their complex to ensure adequate backup water supplies during a fire event. The flexible water storage bladder will be seated on suitable ground with 100 metres clearance from any legal boundaries.



### What needs consent

---

1. A home owner wants to place a flexible water storage bladder in the basement of their house to supply water during emergencies. A building consent is required for this building work because the bladder would be located in the building and is therefore not 100 metres away from the residential building.
2. A farmer wants to place a flexible water bladder on their land 25 metres from the boundary. A building consent is required for this building work because the distance from the boundary is less than 100 metres.
3. A contractor wants to carry out building work to install a 250,000 litre flexible water storage bladder. A building consent is required because the bladder's capacity exceeds 200,000 litres.
4. A property owner wants install a flexible water storage bladder to store potable water for use in an emergency. A building consent is required because the stored water is not solely intended to be used for irrigation or firefighting purposes.



### What the law says

#### Schedule 1 of the Building Act 2004

#### 23A. Flexible water storage bladders

1. Building work in connection with a flexible water storage bladder that—
  - (a) is on the ground; and
  - (b) has an overall height of no more than 2 metres; and
  - (c) does not exceed 200,000 litres in capacity; and
  - (d) is at least 100 metres from any residential building or legal boundary;  
and
  - (e) is used exclusively for irrigation or firefighting purposes.





## 12. Signage

---

This section includes construction of both small and large signs.

For large sign removal, please see section 1.

The table below shows the exemptions included in this section and the professional you will need to hire.

Description*	Is an authorised professional legally required?	Who can provide professional advice?
12.1. Signs up to 6 square metres, with 3 metre height limit	No	Licensed Building Practitioner
12.2. Signs with no restrictions on size	Yes, for both construction and demolition	Chartered Professional Structural Engineer

\*Owners must look at the relevant section of guidance to identify under which detailed conditions the building work qualifies for the exemption.

## 12. Signage

### 12.1. Signs up to 6 square metres, with 3 metre height limit



The term 'surface area' in subclause (a) of this exemption refers to a single face of the sign. For example, the exemption would allow you to build a freestanding sign up to 2 metres by 3 metres and displaying information on both sides.

To work out the height of your sign and make sure it is within the 3 metre height limit for this exemption, measure the vertical distance between the highest point at the top of the sign and the lowest point of the supporting ground below the sign.

Also refer to exemption 39 (section 12.2) regarding building work for which the design has been carried out or reviewed by a chartered professional engineer.



If you are proposing to put signs on heritage or character buildings or in urban areas, it is important to check with the local council first. There may be restrictions in the council's district plan (made under the Resource Management Act 1991) on the type of signs you can construct without first having to obtain a resource consent.

## Examples

---



### What is exempt

---

1. A new 1 square metre sign attached to the side of a building, where the highest point of the sign is no more than 3 metres above the supporting ground level.
2. A 2 square metre freestanding sign located outside a café, where the highest point of the sign is 2 metres above the ground.
3. A 4 square metre roadside billboard, where the highest point of the billboard is no more than 3 metres above the supporting ground level.



### What needs consent

---

1. Installing a 20 square metre sign that has not been designed by a chartered professional engineer. As the sign is greater than 6 square metres in surface area, a building consent is required.
2. Replacing a 4 square metre sign attached to a commercial building 6 metres above the supporting ground level. As the sign is more than 3 metres above the supporting ground level, this will require a building consent.



### What the law says

#### Schedule 1 of the Building Act 2004

---

#### 25. Signs

1. Building work in connection with a sign (whether free-standing or attached to a structure) and any structural support of the sign if:
  - (a). no face of the sign exceeds 6 square metres in surface area; and
  - (b). the top of the sign does not exceed 3 metres in height above the supporting ground level.

## 12. Signage

---

### 12.2. Signs with no restrictions on size



Legally required professional:

**Chartered Professional Engineer**

Unlike exemption 25 (Section 12.1) which also relates to signs, this exemption places no restriction on size or height above the supporting ground as long as the design of the sign, including mounting and any foundation details, has been carried out or reviewed by a Chartered Professional Engineer.



If you are proposing to put signs on heritage or character buildings or in urban areas, it is important to check with the local council first. There may be restrictions in the council's district plan (made under the Resource Management Act 1991) on the type of signs you can construct without first having to obtain a resource consent.

For removal of these signs, [refer to the removal of structures ↑](#) section.



## Examples

---



### What is exempt

---

1. Any sign designed by a Chartered Professional Engineer.



### What needs consent

---

1. Installing a 20 square metre sign that has not been designed or reviewed by a Chartered Professional Engineer. The sign is not covered by this exemption as a Chartered Professional Engineer was not involved. It is also too large to be covered by exemption 25 (section 12.2), so its installation will require a building consent.



### What the law says

---

#### Schedule 1 of the Building Act 2004

---

#### 39. Signs

---

1. Building work in connection with any sign (whether freestanding or attached to a structure), and any structural support of the sign.



# 13. Support structures

---

This section includes construction of both small and large retaining walls. For large retaining wall removal, please see section 1. This also includes small pipe supporting structures on private land for water only.

The table below shows the exemptions included in this section and the professional you will need to hire.

Description*	Is an authorised professional legally required?	Who can provide professional advice?
13.1. Structures supporting water pipe	No	Chartered Professional Engineer
13.2. Retaining walls up to 1.5 metres depth of ground without surcharge	No	Licensed Building Practitioner or Chartered Professional Engineer
13.3. Retaining walls up to 3 metres depth of ground	Yes, for both construction and demolition	Chartered Professional Engineer

\*Owners must look at the relevant section of guidance to identify under which detailed conditions the building work qualifies for the exemption.

# 13. Support structures

## 13.1. Structures supporting water pipes



Pipe supports are commonly used to hold the suspended pipes and to resist the weight of pipes. The pipe supports also restrain pipes during lateral and vertical movements. The overall design of a pipe support is dependent on the loading and operating conditions.

The pipes are used to transfer water (or other liquids) from one location to another within private land (including farms) for various purposes. However, in order to reduce the risks to people and other properties or infrastructure, this exemption only applies to water pipes.

Pipe supports owned or controlled by network utility operators are already exempt from a building consent.



Always check with your council to make sure your proposed building work does not have any district planning implications, considering maximum site coverage, yard or setback requirements, daylight access planes or permitted activities. A resource consent may be required and it is important that you obtain this before starting any building work.

## Examples



### What is exempt

1. An owner wants to transfer water from a reservoir to a consumption point on their private land which is 5 metres from the legal boundary. The size of the pipe is less than 300 millimetres in diameter and it is suspended on a pipe support that has a maximum height of 1000 millimetres above the ground.



### What needs consent

1. A farmer wants to transport livestock effluent from one point to another on their private land via a pipe positioned more than 5 metres from existing dwellings. A building consent is required to build a pipe supporting structure since the pipe will transport a liquid other than the water.



### What the law says

#### Schedule 1 of the Building Act 2004

#### 28B. Structures supporting water pipes

1. Building work in connection with a pipe-supporting structure that—
  - (a). is on the ground; and
  - (b). has an overall height, excluding the pipe, of no more than 1 metre; and
  - (c). is at least 5 metres from any residential building, public road, railway, or legal boundary; and
  - (d). is on private land with no public access to the structure; and
  - (e). supports a single pipe that—
    - (i). has a maximum diameter of 300 millimetres; and
    - (ii). transports only water.

# Notes for Retaining walls: 13.2-13.3

---

There are two separate exemptions for retaining walls. You will need to check which professional to hire according to the specifications.

- Retaining walls built in up to 1.5 metres depth of ground
- Retaining walls built in up to 3 metres depth of ground, when the design is carried out or reviewed by a Chartered Professional Engineer.

## 13. Support structures

---

### 13.2. Retaining walls up to 1.5 metres depth of ground without surcharge



This exemption allows you to build a retaining wall (which is any wall constructed to retain or support the surrounding ground) without needing to get a building consent as long as it does not retain more than 1.5 metres (vertically) of ground and it includes ground water drainage in relation to retaining walls.

This exemption does not apply to retaining walls that are subject to any additional load or surcharge (see photos on next page), such as:

- vehicle driveways
- parking spaces
- swimming pools
- buildings
- other retaining walls
- sloping ground above the top of the retaining wall.

Also refer to exemption 13.3. (retaining walls): this exemption covers building work relating to some retaining walls in rural zones as long as the design is carried out or reviewed by a Chartered Professional Engineer.

**i** If the ground above the top of the retaining wall is only gently sloping, this may not be considered as 'surcharge'. To determine the impact of the sloping ground and its pressure on the stability of the proposed retaining wall, you may wish to seek professional advice, for example, from a chartered professional engineer.

If there is a fall of 1 metre or more from the retaining wall, you may be required to install a safety barrier (under Building Code clause F4 – Safety from falling). Factors to consider include the purpose or use of the retaining wall, how accessible it is, and whether it is frequented by young children.

## Examples



### What is exempt

1. A builder plans to reconstruct an earthquake-damaged timber retaining wall that is less than 1.5 metres high. There is no surcharge on the retaining wall, so a consent is not needed.
2. A motel owner decides to terrace the motel's uphill sloping section by building three 1.2 metre high concrete crib retaining walls to create three level platforms, each of which will be planted. As there will be sufficient horizontal separation between each of the retaining walls so that no surcharge load will be imposed on a lower wall, no building consent will be needed.

### Retaining walls without surcharge and no greater than 1.5 metres high – no consent required.

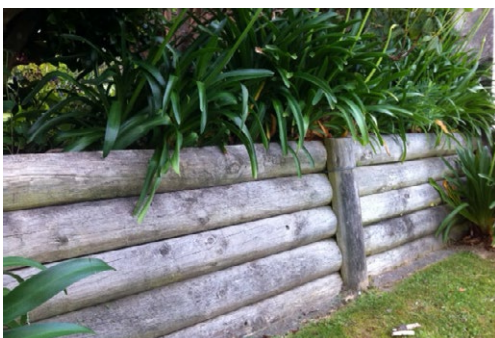





### What needs consent

1. An owner wishes to form a level platform for a garden below a neighbour's driveway. To do this, she intends to construct a 1.2 metre high retaining wall. As the proposed retaining wall is subject to a surcharge from the neighbour's vehicle driveway, it will require a building consent.
2. A retaining wall ranges in height from 900 millimetres to 1.8 metres. The part of the retaining wall that exceeds the maximum allowable height of 1.5 metres will require a building consent.

### Retaining walls with surcharge, regardless of height – consent required



Sloping ground



Parking spaces



Building



### What the law says

#### Schedule 1 of the Building Act 2004

#### 20. Retaining walls

1. Building work in connection with a retaining wall that:
  - (a). retains not more than 1.5 metres depth of ground; and
  - (b). does not support any surcharge or any load additional to the load of that ground (for example, the load of vehicles).

## 13. Support structures

---

### 13.3. Retaining walls up to 3 metres depth of ground



Legally required professional:

**Chartered Professional Engineer**

This exemption extends what is allowable without a building consent under exemption 20 (Section 13.2) – retaining walls.

It also exempts retaining walls designed or reviewed by a Chartered Professional Engineer of up to 3 metres and in a rural zone as long as they are not too close from the boundary or existing buildings (refer to subclause (1)(b)).

This exemption recognises that in low density rural zones such as farms, the consequences of failure of any retaining wall are less likely to cause injury than they would be in higher density urban environments. The additional requirement for a Chartered Professional Engineer to be involved also helps to make sure that retaining walls covered under this exemption are less likely to fail.



Note: If there is a fall of at least 1 metre, a safety barrier may be required under Building Code clause F4 – Safety from falling.

For removal of retaining walls, [please refer to the removal of structures](#) ↑ section.

## Examples



### What is exempt

1. Constructing a retaining wall on a rural property that is 2.5 metres high, 3 metres away from an existing dwelling, and is designed by a Chartered Professional Engineer.
- 
2. A farmer decides to rebuild an earthquake-damaged retaining wall on their rural property that is 3 metres high and located 6 metres away from a legal boundary. The wall design has been reviewed by a Chartered Professional Engineer.



### What needs consent

1. Constructing a retaining wall on a rural property with a height of 3 metres, 1 metre away from an existing dwelling and designed by a Chartered Professional Engineer. A building consent is required because the wall is closer to the dwelling than its own height.
- 
2. Constructing a retaining wall on a rural property that is 3 metres high and 5 metres away from the property boundary which has been designed by an engineer, but not a Chartered Professional Engineer. Though the retaining wall is not located closer to a legal boundary than its own height, a building consent is required as the wall has not been designed or reviewed by a Chartered Professional Engineer.



### What the law says

#### Schedule 1 of the Building Act 2004

#### 41. Retaining walls

1. Building work in connection with a retaining wall in a rural zone, if:
  - (a) the wall retains not more than 3 metres depth of ground; and
  - (b) the distance between the wall and any legal boundary or existing building is at least the height of the wall.
2. In subclause (1), rural zone means any zone or area (other than a rural residential area) that, in the district plan of the territorial authority in whose district the building work is to be undertaken, is described as a rural zone, rural resource area, or rural environment, or by words of similar meaning.



## 14. Other structures

---

This section includes photovoltaic solar panel arrays in both urban and rural zones, outdoor fireplaces or ovens, temporary storage stacks and plinths.

For removal of plinths, please refer to the removal of structures section.

The table below shows the exemptions included in this section and the professional you will need to hire.

Description*	Is an authorised professional legally required?	Who can provide professional advice?
14.1. Ground-mounted solar panel arrays	No	Electrician or Chartered Professional Engineer
14.2. Ground-mounted solar panel arrays exceeding 20, but not exceeding 40, squares metres in size (outside rural zones)	Yes	Electrician or Chartered Professional Engineer
14.3. Permanent outdoor fireplaces and ovens	No	Licensed Building Practitioner or Chartered Professional Engineer or Plumber or Gasfitter
14.4. Temporary storage stacks	No	Licensed Building Practitioner or Chartered Professional Engineer
14.5. Plinths	Yes	Chartered Professional Engineer

\* Owners must look at the relevant section of guidance to identify under which detailed conditions the building work qualifies for the exemption.

# Notes for Ground-mounted solar panel arrays: 14.1-14.2

---

There are two separate exemptions for solar panel arrays. You will need to check if a professional is required according to the descriptions.

- Ground-mounted solar panel arrays outside rural zones up to 20 square metres in size or in rural zones with no size limitation
- Ground-mounted solar panel arrays exceeding 20, but not exceeding 40, square metres in size outside rural zones. Ground-mounted solar panel arrays up to 40 square metres in size can be built when the design is carried out or reviewed by a Chartered Professional Engineer.

**Before you begin your project, you need to consider the following:**

---

## **District planning**

Always check with your local council to make sure your proposed building work does not have any district planning implications taking consideration of maximum site coverage, yard or setback requirements, daylight access planes or permitted activities. A resource consent may be required and it is important that this is obtained before starting any building work.

## **Electrical regulations**

It is important to make sure all ground-mounted solar panel arrays comply with the relevant electrical regulations and standards.

Further to local council regulations, if an owner wants to connect the solar panel arrays to the power grid they must comply with local line companies. Your local council will look at certain installation and electrical safety requirements, as solar power systems might overload the power grid and the relevant authorities make sure this does not occur.

The typical weight of solar panel arrays is assumed to be less than 30 kilograms/square metre (approximately 15-20 kilograms/square metre). The solar panel arrays are comprised of individual panels with different length, width, and thickness.

### Location

The design wind speed at the location for the solar panel must not exceed 44 metres per second or alternatively, the wind zone must not exceed the “high” wind zone per the Building Code provisions. An owner can find all the information about the design wind speeds or wind zones in NZS 3604 and AS/NZS 1170.2 which are both referenced in B1/VM1 or B1/AS1. Most councils also have generic wind zone information for their jurisdictions.

To qualify for this exemption, the ground-mounted solar panel arrays are required to be supported by multiple connections on multiple posts or columns. Single post or column construction is considered to put adjacent property and people at a higher risk of harm in the event of failure.

This exemption allows solar panel arrays to be located as close as 5 metres from a residential building (dwelling). However, when determining the position of the panels, consideration needs to be given to:

- ensuring there is a reasonable separation distance if the residential building (or solar panel arrays) experiences structural instability, such as during an earthquake, strong wind, or fire
- ensuring that escape routes from an existing residential building are not compromised.

## 14. Other structures

---

### 14.1. Ground-mounted solar panel arrays



Solar panel arrays outside of rural zones are limited to 20 square metres, including any existing ground-mounted solar panel arrays. The size of solar panels must be measured (including the existing ones) according to the actual size of panels installed.

In rural zones the likelihood of encountering an existing infrastructure and people is significantly lower than in urban zones. For this reason, as long as all conditions in this exemption are met, there is no restriction on the size of ground-mounted solar array panels in rural zones.

Before you begin, please read the Notes for ground-mounted solar panel arrays on page 198.



## Examples

---



### What is exempt

---

1. An urban dwelling owner intends to erect 15 square metres of ground-mounted solar panel arrays on their land. The council's wind maps classify the location as 'high'. The panels will be fixed to the ground with multiple posts or columns, and will be located 7 metres from the boundary
2. A rural dwelling owner intends to erect ground-mounted solar panel arrays with total surface area of 50 square metres on their property. Council maps indicate the owner's property is in a low wind zone. The panels will be fixed to the ground with multiple support points and located 10 metres from the boundary. As the property is rural, the 20 square metre limit does not apply.



### What needs consent

---

1. An urban-based owner of a dwelling intends to erect 30 square metres of ground-mounted solar panel arrays on their land. The council maps classify the location of the owner's property as a low wind zone. A building consent is required because the size of solar array panels exceed 20 square metres outside of a rural zone.
2. An urban-based owner of a dwelling intends to install 15 square metres of ground-mounted solar panel arrays on their land. The council maps classified the location of the owner's property as a low wind zone. The site plan shows that panels are placed within 2 metres from the residential dwelling. A building consent is required because the panels are located less than 5 metres from a residential building.
3. A rural-based owner of a dwelling intends to erect ground-mounted solar panel arrays on their land. Council maps classify the proposed location as an "extra-high" wind zone. A building consent is required as the wind zone exceeds a high level.
4. A farm owner decides to install ground-mounted solar panel arrays on their farm. The owner wants to support the bank of panels with a single post to minimise the disruption on their land due to required excavation. A building consent is required because the owner has opted for a single post or column to support the solar panel arrays.

5. A rural-based owner of a dwelling intends to erect 40 square metres of ground mounted solar panel arrays on their land. Council maps classify the location of the owner's property as a low wind zone, and the panels are to be fixed to the ground with the multiple support points and located with at least 10 metres distance from any boundary. However, the drawings show that the maximum distance from the top of the panels to the ground is 5 metres. A building consent is required because the maximum height of panels from the ground exceeds 4 metres.



### What the law says

#### Schedule 1 of the Building Act 2004

#### 28C. Ground-mounted solar panel arrays

1. Building work in connection with a ground-mounted solar panel array if—
  - (a). the array, if outside a rural zone, does not exceed 20 square metres in size; and
  - (b). the array is supported by a frame or structure that is on the ground; and
  - (c). the frame or structure is attached to the ground by more than a single post; and
  - (d). the distance from the top of the array to the ground does not exceed 4 metres; and
  - (e). the array is at least 5 metres from any residential building, public road, railway, or legal boundary; and
  - (f). either—
    - (i). the design wind speeds do not exceed 44 metres per second (calculated using Verification Method B1/VM1); or
    - (ii). the array is located in a wind zone no greater than high (as defined in Acceptable Solution B1/AS1).

## 14. Other structures

---

### 14.2. Ground-mounted solar panel arrays exceeding 20, but not exceeding 40, squares metres in size (outside rural zones)



Legally required professional:

Engineer

To qualify for this exemption, the size of all the solar panel arrays must be a maximum of 40 square metres (this size includes any existing ground-mounted solar panel arrays). The size of solar panels must be measured (including the existing ones) according to the actual size of panels installed.

Before you begin, please read the Notes for ground-mounted solar panel arrays on page 198.

If using this exemption, a homeowner must engage a Chartered Professional Engineer to design the necessary fixings to support the solar panel arrays greater than 20 square metres and not exceeding 40 square metres and subsequently, the work must be carried out in accordance with that design. Some suppliers and manufacturers of proprietary products have pre-engineered kit-sets with a unified sign-off from a chartered professional engineer.

## Examples

---



### What is exempt

---

1. An owner of urban-based dwelling intends to build 35 square metres of ground-mounted solar panel arrays on their land. Council maps indicate the location of the owner's property is in a high wind zone. The owner will engage a chartered professional engineer to design the structural supports, connections, fixings and foundation and the subsequent, building work will also be carried out in accordance with that design.



### What needs consent

---

1. An owner of a dwelling in an urban zone wishes to erect a 45 square metres of ground-mounted solar panel arrays on their land. A building consent is required because the size of solar panels exceed 40 square metres.
2. An owner in an urban area intends to erect a 35 square metres of ground-mounted solar panel arrays on their land. The council wind maps indicate that the owner's property is in an extra high wind zone. A building consent is required because the wind speed zone exceeds a "high" rating.



### What the law says

---

#### Schedule 1 of the Building Act 2004

---

#### 48. Ground-mounted solar panel arrays exceeding 20, but not exceeding 40, square metres in size (outside rural zones)

---

1. Building work in connection with a ground-mounted solar panel array outside a rural zone if—
  - (a). the array is supported by a frame or structure that is on the ground; and
  - (b). the frame or structure is attached to the ground by more than a single post; and
  - (c). the distance from the top of the array to the ground does not exceed 4 metres; and
  - (d). the array exceeds 20 square metres in size, but does not exceed 40 square metres; and
  - (e). the array is at least 5 metres from any residential building, public road, railway, or legal boundary; and
  - (f). either—
    - (i). the design wind speeds do not exceed 44 metres per second (calculated using Verification Method B1/VM1); or
    - (ii). the array is located in a wind zone no greater than high (as defined in Acceptable Solution B1/AS1).

## 14. Other structures

### 14.3. Permanent outdoor fireplaces and ovens



Outdoor permanent fireplaces and ovens must always be located at least 1 metre away from any combustible objects such as trees, shrubs, buildings or wood storage piles. Users should always follow the manufacturer's safety precautions. This exemption only applies to those fireplaces or ovens with a cooking or fire surface of no more than 1 square metres.

Outdoor fireplaces or ovens should be installed by a competent person in accordance with the manufacturer's instructions and AS/NZS2918 (for solid fuel appliances). Gas burning outdoor fireplaces or ovens must be installed by an authorised Gasfitter.

Freestanding fireplaces or ovens must be anchored and restrained as outlined in supplier/manufacturer instructions.

Even though an outdoor fireplace or oven can be constructed 1 metre from a boundary, a fire permit may require it to be 3 metres away in order to be lit.

[AS/NZS2918 Domestic solid fuel burning appliances – installation](#)

[Requirements for getting a fire permit](#) from Fire and Emergency New Zealand.

**i** Check with Fire and Emergency New Zealand and your local council regarding any local outdoor fire regulations, standards or permits before installing or using any permanent outdoor fireplace or oven. There may be additional rules associated with 'smoke nuisance' to surrounding properties areas. For example, you must not light your fire within 3 metres of a building, hedge or anything else that could catch fire according to the requirements of Fire and Emergency New Zealand.

## Examples

---



### What is exempt

---

1. A homeowner wishes to construct a free-standing and permanent pizza oven in the back yard with the minimum 1 metre distance from the street fence. The maximum cooking surface is less than 1 square metres, the top of the flue is 2.4 metres above the ground level and the oven is to be secured to the base in accordance with the manufacturer's instructions.



### What needs consent

---

1. Constructing a fire place attached to the existing dwelling or a shed.
2. A restaurant owner wants to build a freestanding fire place in the outdoor area of their restaurant. The surface fire area of the fire place is 2.25 square metres. A building consent is required for this building work as the fire surface exceeds 1 square metres.
3. A dwelling owner wants to build a fire place under an existing roofed sun-shelter. The existing free-standing sun-shelter was built on the land and is enclosed by the roof and walls on two sides. A building consent is required for this building work because the fire place is located in a roofed space.



### What the law says

---

#### Schedule 1 of the Building Act 2004

---

#### 28A. Permanent outdoor fireplaces and ovens

---

1. Building work in connection with a permanent outdoor fireplace or oven that—
  - (a). is on the ground; and
  - (b). is not covered by a roof or wall; and
  - (c). has an overall height of no more than 2.5 metres, and a cooking surface of no more than 1 square metre; and
  - (d). is at least 1 metre from any legal boundary or building; and
  - (e). disposes of smoke in a way that does not create a nuisance to people or a hazard to any property.

## 14. Other structures

---

### 14.4. Temporary storage stacks



This exemption allows you to construct any temporary storage stack of goods or materials. Temporary means lasting for only a limited period. For example, you may be stacking materials during the construction period of a building project, or storing and stacking goods while relocating.

## Examples

---



### What is exempt

---

1. A construction firm is moving location to partially completed new premises. It proposes to erect a temporary timber storage stack on its new site. When complete, the new premises will contain a new timber storage area and the temporary storage stack will be removed.

---

2. While a new building is being constructed, the builders stack metal roofing materials on a timber base to keep the material off the ground until it is ready to use.



### What needs consent

---

1. Owners of a joinery factory want to construct a 4 metre high racking system to store materials for use in manufacturing aluminium windows. They intend to use this racking system indefinitely. This work would not be considered temporary, so it will require a building consent.

---

2. A supermarket owner wishes to extend the racking systems used to store food. This work requires a building consent as the racking system is permanent.



### What the law says

---

#### Schedule 1 of the Building Act 2004

---

#### 27. Temporary storage stacks

---

1. Building work in connection with a temporary storage stack of goods or materials.



## 14. Other structures

---

### 14.5. Plinths



Legally required professional:

Engineer

This exemption recognises that plinths usually involve specific engineering design because of the need to support heavy loads (eg tanks, mechanical items like printing presses and metal working machines, or large statues). It acknowledges the fact that requiring a building consent when the plinth has already been designed by a chartered professional engineer would add compliance costs (which are usually disproportionate to the construction costs) for little benefit.

For removal of plinths, [please refer to the removal of structures](#) ↑ section.

## Examples

---



### What is exempt

---

1. Constructing a plinth (designed by a Chartered Professional Engineer) for a tank.
2. A company plans to build a concrete base to support heavy machinery in a plant room. The base design has been reviewed by a Chartered Professional Engineer.



### What needs consent

---

1. Constructing a reinforced concrete base (not designed or reviewed by a Chartered Professional Engineer) for several stainless steel holding vats in a winery. A building consent is required because the design was neither designed nor reviewed by a Chartered Professional Engineer.



### What the law says

---

#### Schedule 1 of the Building Act 2004

---

#### 40. Plinths

---

1. Building work in connection with any plinth or similar foundation if the plinth or foundation supports plant, a tank, equipment, machinery, or any similar item.





# 15. Network utilities

---

This section includes certain structures owned or controlled by network utility operators or similar.

The table below shows the exemptions included in this section and the professional you will need to hire.

Description	Professional
15.1. Certain structures owned or controlled by network utility operators or similar	Professional within the industry and/or Network Utility Operators (NUOs)

## 15. Network utilities

---

### 15.1. Certain structures owned or controlled by network utility operators or other similar organisations



The purpose of this exemption is to allow building work on certain infrastructure to be carried out.

In many cases, this building work is located on public land and it often crosses territorial authority boundaries.

This type of building work is usually designed, constructed, maintained and supervised by professionals within the industry and/or government agencies known as network utility operators (NUOs).

## Examples

---



### What is exempt

---

1. A new motorway off-ramp has been built and it is proposed to put up a motorway sign to direct vehicles. As the sign is owned by an organisation similar to an NUO, it will not require a building consent.

---

2. A NUO proposes to build a culvert under a road to alleviate local flooding during heavy rainfall.



### What needs consent

---

1. A NUO proposes to build a new office for employees at its sewerage treatment plant. This office would not be considered a simple structure and requires a building consent.



### What the law says

---

#### Schedule 1 of the Building Act 2004

---

#### 29. Certain structures owned or controlled by network utility operators or other similar organisations

1. Building work in connection with a motorway sign, stopbank, culvert for carrying water under or in association with a road, or other similar structure that is:
  - (a). a simple structure; and
  - (b). owned or controlled by a network utility operator or other similar organisation.

## Links to earlier legislation

---

To check whether or not earlier building work on a property was covered by an exemption, you need to refer to the legislation in force at the time.

Schedule 1 of the Building Act 2004 has been issued and amended on the following dates:

- 1 July 2019 (the current version)
- 28 November 2013
- 23 December 2010
- 16 October 2008, and
- 24 August 2004.



You can download these versions at:

[www.legislation.govt.nz/act/public/2004/0072/latest/versions.aspx?av=True](http://www.legislation.govt.nz/act/public/2004/0072/latest/versions.aspx?av=True)



Before the Building Act 2004 was enacted, the Building Act 1991 was the relevant legislation: its Third Schedule (Exempt buildings and building work) was similar to the current Act's Schedule 1. You can download this at: [www.nzlii.org/nz/legis/hist\\_act/ba19911991n150118/](http://www.nzlii.org/nz/legis/hist_act/ba19911991n150118/)



Note:

We have included these links after feedback from building officials, who report that they get regular visits from home buyers and real estate agents wanting to view earlier versions of the legislation and asking council advice whether or not building work undertaken at a given time was exempt. We hope that providing this information will be helpful for both parties.



# Useful links

---

## Websites

---

[www.building.govt.nz](http://www.building.govt.nz)

---

### **Building Code**

[www.building.govt.nz/building-code-compliance](http://www.building.govt.nz/building-code-compliance)

---

### **Technical reviews**

[www.building.govt.nz/building-officials/technical-reviews](http://www.building.govt.nz/building-officials/technical-reviews)

---

### **Determinations**

[www.building.govt.nz/resolving-problems/resolution-options/determinations](http://www.building.govt.nz/resolving-problems/resolution-options/determinations)

---

[www.standards.co.nz](http://www.standards.co.nz)

---

## Sources of professional advice include

---

### **Registered architect**

[www.nzrab.nz/search/](http://www.nzrab.nz/search/)

---

### **Chartered professional engineer:**

[www.engineering.org](http://www.engineering.org)

---

### **Licensed building practitioner (relevant licence class)**

[www.lbp.govt.nz](http://www.lbp.govt.nz)

---

### **Registered building surveyor**

[www.buildingsurveyors.co.nz](http://www.buildingsurveyors.co.nz)

---

### **Building consent authority within your local council (district or city)**

[www.localcouncils.govt.nz](http://www.localcouncils.govt.nz)

---

### **Registered certifying plumber and/or drainlayer**

[www.pgdb.co.nz](http://www.pgdb.co.nz)

---

# Glossary

---

We have included some useful definitions and abbreviations below. For more definitions, refer to the [Building Code Handbook](#).

---

**Abode or place of abode**

As defined in section 7 of the Building Act 2004, abode or place of abode:

- (a). means any place used predominantly as a place of residence or abode, including any appurtenances belonging to or enjoyed with the place; and
  - (b). includes:
    - (i). a hotel, motel, inn, hostel, or boarding house;
    - (ii). a convalescent home, nursing home, or hospice;
    - (iii). a rest home or retirement village;
    - (iv). a camping ground;
    - (v). any similar place.
- 

**Acceptable Solution B1/AS1**

The Acceptable Solution for New Zealand Building Code Clause B1 Structure, issued by the chief executive under section 22 and available on the MBIE Internet site, as in force on 28 November 2019.

---

**Alteration**

In relation to a building, includes to rebuild, re-erect, repair, enlarge and extend the building. (Refer to [Section 7 of the Building Act 2004](#).)

---

**Assembly**

A complete unit consisting of assembled components.

---

---

**Authorised person**

An authorised person is defined in the Building Act 2004 section 42A(3) and is:

- a registered certifying plumber or drainlayer, or
- a plumber or drainlayer who carries out the work under the supervision of a registered certifying plumber or drainlayer – as long as he/she:
  - is registered, or
  - holds a provisional licence, or
  - is under training.

---

**Awning**

A roof-like cover, usually made of fabric or similar lightweight material on a frame, often used to shelter a window, door or the side of a building.

---

**Building Code**

Schedule 1 of the Building Regulations 1992.

---

**Building element**

Any structural or non-structural component and assembly incorporated into or associated with a building. This includes fixtures, services, drains, permanent mechanical installations for access, glazing, partitions, ceilings and temporary supports.

---

**Building work**

Refer to [Section 7 of the Building Act 2004](#).

---

---

<b>Canopy</b>	Projecting hood supported on brackets, corbels or columns over a door, window or niche. (This definition is taken from the Standards New Zealand publication <a href="#">NZMP 4212:1998 Glossary of building terminology</a> ).
<b>Carpport</b>	A roofed structure for motor vehicle storage with at least one side fully open to the outdoors.
<b>Certificate of acceptance</b>	A certificate for building work issued by a territorial authority under Section 96 of the Building Act 2004.
<b>Chartered professional engineer</b>	A professional engineer registered under the Chartered Professional Engineers of New Zealand Act 2002.
<b>Comparable materials</b>	Materials with similar properties having in-situ performance in terms of the Building Code that is not less than that of the existing materials. (Also refer to <a href="#">B2/VM1</a> re 'similar materials').
<b>Component</b>	A part of an assembly.

---

---

**Dam**

As defined in section 7 of the Building Act 2004, a dam:

- (a). means an artificial barrier, and its appurtenant structures, that
  - (i). is constructed to hold back water or other fluid under constant pressure so as to form a reservoir; and
  - (ii). is used for the storage, control, or diversion of water or other fluid; and
- (b). includes:
  - (i). a flood control dam; and
  - (ii). a natural feature that has been significantly modified to function as a dam; and
  - (iii). a canal; but
- (c). does not include a stopbank designed to control floodwaters.

---

**Determination**

A binding decision made by MBIE that provides a way of solving disputes or questions about the rules that apply to buildings, how buildings are used, building accessibility, health and safety.

More information on determinations see:  
Sections 176-190 of the Building Act 2004.

---

---

**Drainlaying**

As defined in section 4 of the Plumbers, Gasfitters and Drainlayers Act 2006, drainlaying means—

- (a). laying a drain;
- (b). altering, reconstructing, extending, repairing, opening up, or renewing a drain or a fitting connected to a drain;
- (c). fixing or unfixing a drain to or from a sewage tank; and
- (d). fixing or unfixing a gully-trap or other trap in connection with a drain or sewage tank.

---

**Exempt**

Used in this guidance to refer to building work that does not require a building consent; in particular, under one or more of the clauses in Schedule 1 of the Building Act 2004.

---

**Finishes**

Coatings and paints used to protect the surface of a particular material.

---

**Fixture**

An article intended to remain permanently attached to, and form part of, a building.

---

**Ground floor**

The floor of a building at ground level.

---

---

<b>Ground moisture barrier</b>	<p>A polythene film with a vapour flow resistance of no less than 50 MN s/g and a thickness of no less than 0.25mm, such as 250 micron polythene.</p> <p>(Refer to regulation 28 of the <a href="#">Residential Tenancies (Healthy Homes Standards) Regulations 2019</a>).</p>
<b>Height-restriction gantry</b>	<p>Overhead structure which restricts vehicles from passing underneath, such as in a car park or underpass.</p>
<b>Hoarding</b>	<p>A structure alongside a public way providing side protection but no overhead protection. (This definition is taken from the compliance document <a href="#">F5/AS1</a> for Building Code clause F5 – Construction and demolition hazards.)</p>
<b>HSNO Act</b>	<p>Hazardous Substances and New Organisms Act 1996.</p>
<b>Independent Qualified Person</b>	<p>A person approved by Council to carry out or supervise all of some of the inspection, maintenance and reporting procedures required for a specified system stated in a compliance schedule.</p>
<b>Lawful repair</b>	<p>Repairs that comply with the Building Code and other legislation.</p>
<b>Linings</b>	<p>The rigid sheet covering for a wall, ceiling or interior surface.</p>

---

---

**Maintenance**

Lawful repair using comparable materials in the same position to replace something that wore out through normal wear and tear.

---

**MBIE**

Ministry of Business, Innovation and Employment.

---

**Net floor area**

The total usable floor area in a building, measured to the inside of the enclosing walls.

---



---

**Network utility operator (NUO)**

As defined in section 7 of the Building Act 2004, a person who:

- (a). undertakes or proposes to undertake the distribution or transmission by pipeline of natural or manufactured gas, petroleum, or geothermal energy; or
- (b). operates or proposes to operate a network for the purpose of:
  - (i). telecommunication as defined in section 5 of the Telecommunications Act 2001; or
  - (ii). radiocommunications as defined in section 2(1) of the Radiocommunications Act 1989; or
- (c). is an electricity operator or electricity distributor as defined in section 2 of the Electricity Act 1992 for the purpose of line function services as defined in that section; or
- (d). undertakes or proposes to undertake the distribution of water for supply (including irrigation); or
- (e). undertakes or proposes to undertake a drainage or sewerage system.

---

**Open-vented water storage heater**

A water heater incorporating a vent pipe which is permanently open to the atmosphere.

---

**Outbuilding**

A building classified as an outbuilding under clause A1 of the Building Code.

---

**Patio**

A roofless, paved outdoor area adjoining a building.

---

---

<b>Pergola</b>	An exterior, decorative open-framed structure often to support climbing or trailing plants.
<b>Playground equipment</b>	Equipment and structures with, or on which, children can play.
<b>Plinth</b>	A supporting base.
<b>Pool</b>	<p>As defined in section 7 of the Building Act 2004, pool:</p> <p>(a). a) means</p> <ul style="list-style-type: none"><li>(i). any excavation or structure of a kind normally used for swimming, paddling, or bathing; or</li><li>(ii). any product (other than an ordinary home bath) that is designed or modified to be used for swimming, wading, paddling, or bathing; but</li></ul> <p>(b). does not include an artificial lake.</p>
<b>Porch</b>	<p>Projecting or recessed covered space at the entrance to a building or structure. (This definition is taken from the Standards New Zealand publication <a href="#">NZMP 4212:1998 Glossary of building terminology</a>).</p>
<b>Potable water</b>	Water that is suitable for human consumption.

---

---

<b>Primary structure</b>	Building elements that are intended to contribute to the building's ability to withstand vertical or horizontal loads (eg its beams, bracing, columns, foundations, roof, sub-floor framing and walls).
<b>Regional authority</b>	A regional council or a unitary authority (refer to <a href="#">Section 7 of the Building Act 2004</a> ).
<b>Residential pool</b>	As defined in section 7 of the Building Act 2004, residential pool means a pool that is: <ul style="list-style-type: none"><li>(a). in a place of abode; or</li><li>(b). in or on land that also contains an abode; or</li><li>(c). in or on land that is adjacent to other land that contains an abode if the pool is used in conjunction with that other land or abode.</li></ul>
<b>Rodding point</b>	A removable cap at ground level through which access may be made for cleaning and inspecting the drainage system.
<b>Rural zone</b>	Any zone or area (other than a rural residential area) that, in the district plan of the territorial authority in whose district the building work is to be undertaken, is described as a rural zone, rural resource area, rural environment or by words of similar meaning.
<b>Sanitary plumbing</b>	Refer to section 6 of the Plumbers, Gasfitters and Drainlayers Act 2006.

---

---

<b>Shade sail</b>	Fabric or similar lightweight material extended over an outdoor area to provide shelter or protection from direct sunlight.
<b>Sign</b>	A structure, including any structural support, for the purpose of conveying information or an instruction.
<b>Solar panel array</b>	Multiple solar panels comprising of photovoltaic cells connected together and used to generate electricity.
<b>Small heated pool</b>	As defined in section 7 of the Building Act 2004, small heated pool means a heated pool (such as a spa pool or hot tub) that:  (a). has a water surface area of 5 square metres or less; and  (b). is designed for therapeutic or recreational use.
<b>Solid-fuel heater</b>	Solid-fuel burning appliance such as a wood burner.
<b>Stall</b>	A temporary structure erected by merchants to display and/or shelter their merchandise or products.
<b>Stopbank</b>	Structures built along water courses such as rivers or streams to prevent the surrounding land from flooding.
<b>Specified system</b>	Refer to <a href="#">Section 7 of the Building Act 2004</a> .

---

---

**Subfloor space**

A building with a suspended floor will have a subfloor space. The subfloor space is enclosed if the airflow into and out of the space is significantly obstructed along at least 50% of its perimeter by 1 or more of the following:

- (a). a masonry foundation wall;
- (b). cement boards, timber skirting, or other cladding;
- (c). other parts of the building or any adjoining structure;
- (d). any other permanent or semi-permanent structure that significantly obstructs airflow;
- (e). rock, soil, or other similar material.

(Refer to regulation 28 of the [Residential Tenancies \(Healthy Homes Standards\) Regulations 2019](#)).

---

**Supplementary heat exchanger**

A device built for efficient heat transfer from one medium to another.

---

**Supporting ground**

Ground which is bearing all or part of the loads from building work.

---

**Surcharge**

A load imposed by adjacent activities (eg vehicle movement, parking or storage stacks), buildings or structures.

---

**Temporary**

Intended to last or to be maintained in place for only a limited and relatively short period of time.

---

---

<b>Territorial authority</b>	Refer to <a href="#">Section 7 of the Building Act 2004</a> .
<b>Veranda</b>	A roofed space extending from a building. (This definition is taken from the Standards New Zealand publication <a href="#">NZMP 4212:1998 Glossary of building terminology</a> )
<b>Verification Method B1/VM1</b>	The Verification Method for New Zealand Building Code Clause B1 Structure, issued by the chief executive under section 22 and available on MBIE's Internet site, as in force on 28 November 2019.
<b>Water storage heater</b>	A water tank with an integral water heater for the storage of hot water.
<b>Wet area shower</b>	A shower with a floor that is a continuation of the bathroom floor rather than a separate raised shower tray or cubicle. Also known as a level entry shower.

---





**MINISTRY OF BUSINESS,  
INNOVATION & EMPLOYMENT**  
HĪKINA WHAKATUTUKI

New Zealand Government